

con acciaio inox o prim. lega pat. bronzo



ART. 0042 R T
↓ 28 ↔ 16,5 cm

ART. 0041 P
↓ 28 ↔ 16,5 cm



ART. 0079 R T ART. 0679 R P
↓ 20 ↔ 11 cm ↓ 20 ↔ 11 cm

ART. 0078 P ART. 0678 P
↓ 20 ↔ 11 cm ↓ 20 ↔ 11 cm



ART. 0233 R T ART. 0275 R P
↓ 18 ↔ 16 cm ↓ 18 ↔ 16 cm

ART. 0232 P ART. 0274 P
↓ 18 ↔ 16 cm ↓ 18 ↔ 16 cm



ART. 0044 R T
↓ 28 ↔ 16,5 cm

ART. 0043 P
↓ 28 ↔ 16,5 cm



ART. 0099 R T ART. 0699 R P
↓ 20 ↔ 11 cm ↓ 20 ↔ 11 cm

ART. 0098 P ART. 0698 P
↓ 20 ↔ 11 cm ↓ 20 ↔ 11 cm



ART. 0235 R T ART. 0277 R P
↓ 18 ↔ 16 cm ↓ 18 ↔ 16 cm

ART. 0234 P ART. 0276 P
↓ 18 ↔ 16 cm ↓ 18 ↔ 16 cm



ART. 0122 Ø 6 T
↓ 26 ↔ 12 cm



ART. 0123 Ø 5 T ART. 0184 Ø 5 P
↓ 20 ↔ 8,5 cm ↓ 20 ↔ 8,5 cm



ART. 0124 Ø 6 T
↓ 26 ↔ 12 cm



ART. 0125 Ø 5 T ART. 0185 Ø 5 P
↓ 20 ↔ 8,5 cm ↓ 20 ↔ 8,5 cm



ART. 0506 9x12 cm
ART. 0507 11x15 cm
ART. 0508 13x18 cm



ART. 0554 9x12 cm
ART. 0555 10x15 cm
ART. 0556 11x15 cm
ART. 0557 13x18 cm

STONAT

con acciaio inox o prim. lega pat. bronzo



| | | | | | | |
|-------------------------------------|---|-----------------------------|-------------------------------------|---|---------------------------------------|---|
| INOX ART. 0014 R ↓ 29 ↔ 18 cm | PR. LEGA BRONZO ART. 0012 R ↑ 29 ↔ 18 cm | ART. 0022 P ↓ 26 ↔ 16 cm | INOX ART. 0011 R ↓ 21 ↔ 13 cm | PR. LEGA BRONZO ART. 0010 R ↓ 21 ↔ 13 cm | INOX ART. 0025 R/C ↓ 19 ↔ 10 cm | PR. LEGA BRONZO ART. 0023 R ↓ 19 ↔ 10 cm |
| ART. 0015 P ↓ 29 ↔ 18 cm | ART. 0013 P ↓ 29 ↔ 18 cm | | ART. 0018 P ↓ 21 ↔ 13 cm | ART. 0019 P ↓ 21 ↔ 13 cm | ART. 0026 P ↓ 19 ↔ 10 cm | ART. 0024 P ↓ 19 ↔ 10 cm |



| | | | | | |
|--------------------------------------|--|---|---------------------------------------|---|----------------------------|
| INOX ART. 0029 R/C ↓ 14 ↔ 8 cm | PR. LEGA BRONZO ART. 0027 R ↓ 14 ↔ 8 cm | INOX ART. 0036 P ↓ 11 ↔ 6 cm | INOX ART. 0211 R/C ↓ 18 ↔ 17 cm | PR. LEGA BRONZO ART. 0210 R ↓ 18 ↔ 17 cm | ART. 46709 ↓ 27 ↔ 15 cm |
| ART. 0030 P ↓ 14 ↔ 8 cm | ART. 0028 P ↓ 14 ↔ 8 cm | PR. LEGA BRONZO ART. 0031 P ↓ 11 ↔ 6 cm | ART. 0213 P ↓ 18 ↔ 17 cm | ART. 0212 P ↓ 18 ↔ 17 cm | |



| | | | |
|--|---|---|----------------------------|
| INOX ART. 0113 Ø 6 ↓ 26 ↔ 14 cm | INOX ART. 0111 Ø 5 ↓ 20 ↔ 9 cm | INOX ART. 0115 Ø 4 ↓ 14 ↔ 7 cm | ART. 46707 ↓ 18 ↔ 13 cm |
| PR. LEGA BRONZO ART. 0112 Ø 6 ↓ 26 ↔ 14 cm | PR. LEGA BRONZO ART. 0110 Ø 5 ↓ 20 ↔ 9 cm | PR. LEGA BRONZO ART. 0114 Ø 4 ↓ 14 ↔ 7 cm | ART. 46708 ↓ 22 ↔ 17 cm |



| | | |
|--------------------|--------------------|------------------------|
| ART. 0504 6x8 cm | ART. 0550 9x12 cm | ART. 0400 ↓ 15 ↔ 9 cm |
| ART. 0505 7x9 cm | ART. 0552 10x15 cm | ART. 0401 ↓ 20 ↔ 11 cm |
| ART. 0502 8x10 cm | ART. 0551 11x15 cm | ART. 0402 ↓ 30 ↔ 14 cm |
| ART. 0500 9x12 cm | ART. 0553 13x18 cm | ART. 0403 ↓ 40 ↔ 5 cm |
| ART. 0501 11x15 cm | | |
| ART. 0503 13x18 cm | | |

STONAT

con acciaio inox o prim. lega pat. bronzo



INOX
ART. 0051 R
↓ 21 ↔ 13 cm

PR. LEGA BRONZO
ART. 0050 R
↓ 21 ↔ 13 cm

ART. 0016 P
↓ 21 ↔ 13 cm

ART. 0017 P
↓ 21 ↔ 13 cm



INOX
ART. 0053 R/C
↓ 19 ↔ 10 cm

PR. LEGA BRONZO
ART. 0052 R
↓ 19 ↔ 10 cm

ART. 0021 P
↓ 19 ↔ 10 cm

ART. 0020 P
↓ 19 ↔ 10 cm



INOX
ART. 0056 R/C
↓ 14 ↔ 8 cm

PR. LEGA BRONZO
ART. 0054 R
↓ 14 ↔ 8 cm

ART. 0057 P
↓ 14 ↔ 8 cm

ART. 0055 P
↓ 14 ↔ 8 cm



INOX
ART. 0063 P
↓ 11 ↔ 6 cm

PR. LEGA BRONZO
ART. 0058 P
↓ 11 ↔ 6 cm



INOX
ART. 0251 R/C
↓ 18 ↔ 17 cm

PR. LEGA BRONZO
ART. 0250 R
↓ 18 ↔ 17 cm

ART. 0253 P
↓ 18 ↔ 17 cm

ART. 0252 P
↓ 18 ↔ 17 cm



INOX
ART. 0258 P
↓ 17 ↔ 17,5 cm

PR. LEGA BRONZO
ART. 0259 P
↓ 17 ↔ 17,5 cm



ART. 46909 P
↓ 18 ↔ 13 cm



INOX
ART. 0151 Ø 5
↓ 20 ↔ 9 cm

PR. LEGA BRONZO
ART. 0150 Ø 5
↓ 20 ↔ 9 cm



INOX
ART. 0153 Ø 4
↓ 14 ↔ 7 cm

PR. LEGA BRONZO
ART. 0152 Ø 4
↓ 14 ↔ 7 cm



INOX
ART. 0158 Ø 5
↓ 20 ↔ 13 cm

PR. LEGA BRONZO
ART. 0159 Ø 5
↓ 20 ↔ 13 cm



ART. 0504 6x8 cm
ART. 0505 7x9 cm
ART. 0502 8x10 cm
ART. 0500 9x12 cm
ART. 0501 11x15 cm
ART. 0503 13x18 cm



ART. 0550 9x12 cm
ART. 0552 10x15 cm
ART. 0551 11x15 cm
ART. 0553 13x18 cm



ART. 0400 ↓ 15 ↔ 9 cm
ART. 0401 ↓ 20 ↔ 11 cm
ART. 0402 ↓ 30 ↔ 14 cm
ART. 0403 ↓ 40 ↔ 5 cm

STONAT

con acciaio inox o prim. lega pat. bronzo



PR. LEGA BRONZO

- ART. 0059 R **P** ↓ 20 ↔ 13 cm
- ART. 0060 P ↓ 20 ↔ 13 cm
- ART. 0032 R **T** ↓ 20 ↔ 13 cm
- ART. 0033 P ↓ 20 ↔ 13 cm
- ART. 0037 R ↓ 28 ↔ 18 cm
- ART. 0038 P ↓ 28 ↔ 18 cm



PR. LEGA BRONZO

- ART. 0154 Ø 5 **P** ↓ 21 ↔ 10 cm
- ART. 0116 Ø 5 **T** ↓ 21 ↔ 10 cm
- ART. 0118 Ø 6 ↓ 26 ↔ 14 cm



PR. LEGA BRONZO

- ART. 0254 R **P** ↓ 17 ↔ 17 cm
- ART. 0255 P ↓ 17 ↔ 17 cm
- ART. 0214 R **T** ↓ 17 ↔ 17 cm
- ART. 0215 P ↓ 17 ↔ 17 cm



INOX

- ART. 0061 R **P** ↓ 20 ↔ 13 cm
- ART. 0062 P ↓ 20 ↔ 13 cm
- ART. 0034 R **T** ↓ 20 ↔ 13 cm
- ART. 0035 P ↓ 20 ↔ 13 cm
- ART. 0039 R ↓ 28 ↔ 18 cm
- ART. 0040 P ↓ 28 ↔ 18 cm



INOX

- ART. 0155 Ø 5 **P** ↓ 21 ↔ 10 cm
- ART. 0117 Ø 5 **T** ↓ 21 ↔ 10 cm
- ART. 0119 Ø 6 ↓ 26 ↔ 14 cm



INOX

- ART. 0256 R/C **P** ↓ 17 ↔ 17 cm
- ART. 0257 P ↓ 17 ↔ 17 cm
- ART. 0216 R/C **T** ↓ 17 ↔ 17 cm
- ART. 0217 P ↓ 17 ↔ 17 cm



- ART. 0510 9x12 cm
- ART. 0511 11x15 cm



- ART. 0560 9x12 cm
- ART. 0561 10x15 cm
- ART. 0562 11x15 cm

STONAT



PR. LEGA BRONZO

ART. 0047 R **T**
↓ 28 ↔ 18 cm

ART. 0048 P
↓ 28 ↔ 18 cm

INOX
ART. 0045 R **T**
↓ 28 ↔ 18 cm

ART. 0046 P
↓ 28 ↔ 18 cm



PR. LEGA BRONZO

ART. 0064 R **P** ART. 0080 R **T**
↓ 20 ↔ 13 cm ↓ 20 ↔ 13 cm

ART. 0065 P ART. 0081 P
↓ 20 ↔ 13 cm ↓ 20 ↔ 13 cm

INOX
ART. 0066 R **P** ART. 0082 R **T**
↓ 20 ↔ 13 cm ↓ 20 ↔ 13 cm

ART. 0067 P ART. 0083 P
↓ 20 ↔ 13 cm ↓ 20 ↔ 13 cm



PR. LEGA BRONZO

ART. 0068 R **P** ART. 0084 R **T**
↓ 20 ↔ 13 cm ↓ 20 ↔ 13 cm

ART. 0069 P ART. 0085 P
↓ 20 ↔ 13 cm ↓ 20 ↔ 13 cm

INOX
ART. 0070 R **P** ART. 0086 R **T**
↓ 20 ↔ 13 cm ↓ 20 ↔ 13 cm

ART. 0071 P ART. 0087 P
↓ 20 ↔ 13 cm ↓ 20 ↔ 13 cm



PR. LEGA BRONZO

ART. 0147 Ø 6 **T**
↓ 25 ↔ 11 cm

INOX
ART. 0148 Ø 6 **T**
↓ 25 ↔ 11 cm



PR. LEGA BRONZO

ART. 0164 Ø 5 **P**
↓ 19 ↔ 9 cm

ART. 0180 Ø 5 **T**
↓ 19 ↔ 9 cm

INOX
ART. 0166 Ø 5 **P**
↓ 19 ↔ 9 cm

ART. 0182 Ø 5 **T**
↓ 19 ↔ 9 cm



PR. LEGA BRONZO

ART. 0260 R **P** ART. 0218 R **T**
↓ 19 ↔ 17 cm ↓ 19 ↔ 17 cm

ART. 0261 P ART. 0219 P
↓ 19 ↔ 17 cm ↓ 19 ↔ 17 cm

INOX
ART. 0262 R/C **P** ART. 0220 R/C **T**
↓ 19 ↔ 17 cm ↓ 19 ↔ 17 cm

ART. 0263 P ART. 0221 P
↓ 19 ↔ 17 cm ↓ 19 ↔ 17 cm



PR. LEGA BRONZO

ART. 0264 R **P** ART. 0222 R **T**
↓ 19 ↔ 17 cm ↓ 19 ↔ 17 cm

ART. 0265 P ART. 0223 P
↓ 19 ↔ 17 cm ↓ 19 ↔ 17 cm

INOX
ART. 0266 R/C **P** ART. 0224 R/C **T**
↓ 19 ↔ 17 cm ↓ 19 ↔ 17 cm

ART. 0267 P ART. 0225 P
↓ 19 ↔ 17 cm ↓ 19 ↔ 17 cm



ART. 0512
9x12 cm
ART. 0513
11x15 cm
ART. 0514
13x18 cm

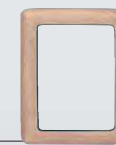

ART. 0563
9x12 cm
ART. 0564
11x15 cm
ART. 0565
13x18 cm



ART. 0515
9x12 cm
ART. 0516
11x15 cm
ART. 0517
13x18 cm



ART. 0566
9x12 cm
ART. 0567
11x15 cm
ART. 0568
13x18 cm



ART. 0404
↓ 15 ↔ 9 cm
ART. 0405
↓ 20 ↔ 11 cm



PERGAMENA PERSONALIZZABILE

- | | | | |
|-----------|--------------|-----------|--------------|
| ART. 0300 | ↓ 5 ↔ 10 cm | ART. 0303 | ↓ 13 ↔ 25 cm |
| ART. 0301 | ↓ 9 ↔ 15 cm | ART. 0304 | ↓ 15 ↔ 30 cm |
| ART. 0316 | ↓ 11 ↔ 15 cm | ART. 0305 | ↓ 18 ↔ 35 cm |
| ART. 0302 | ↓ 11 ↔ 20 cm | ART. 0306 | ↓ 20 ↔ 40 cm |

È possibile personalizzare con i seguenti caratteri scolpiti: new corsivo - fantasy - futuro - romano - futuro stretto
L'altezza minima di questi caratteri è di 6 mm



I testi saranno calcolati in base alla dimensione dell'articolo ed al numero di lettere che si dovranno scrivere,
Al momento dell'ordinazione è necessario specificare il tipo di carattere scelto e se si vuole minuscolo e/o maiuscolo.



MADONNA
ART. 0375
↓ 20,5 ↔ 15 cm



MADONNA
ART. 0376
↓ 20,5 ↔ 15 cm



TRALCIO ROSE
ART. 0360
↓ 14 ↔ 9 cm



TRALCIO ROSE
ART. 0361
↓ 24 ↔ 12 cm



TRALCIO ROSE
ART. 0362
↓ 33 ↔ 12 cm



ACQUASANTIERA
ART. 0373
↓ 14,5 ↔ 12 cm



ANGELO
ART. 0374
↓ 14,5 ↔ 12 cm



STATUA ANGELO SDRAIATO
ART. 0816
↓ 12 ↔ 23,5 cm



STATUA ANGELO
INGINOCCHIATO
ART. 0815
↓ 17 ↔ 11,5 cm

STONAT



MADONNA
ART. 0355
↓ 13 ↔ 9,5 cm



CRISTO
ART. 0356
↓ 13 ↔ 9 cm



MADONNA
ART. 0358
↓ 13 ↔ 9 cm



CRISTO
ART. 0359
↓ 13 ↔ 9 cm



PART. PIETÀ
ART. 0357
↓ 14 ↔ 15 cm



VOLTO CRISTO
ART. 0353
↓ 16 ↔ 10,5 cm



VOLTO MADONNA
ART. 0354
↓ 16 ↔ 10,5 cm



PART. PIETÀ
ART. 0352
↓ 19 ↔ 10 cm



PART. PIETÀ
ART. 0351
↓ 27 ↔ 18 cm



PART. PIETÀ
ART. 0350
↓ 35,5 ↔ 20 cm

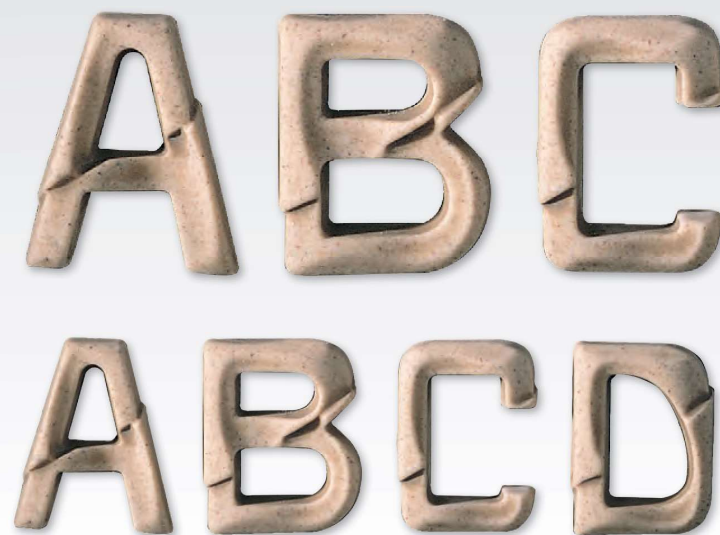

| | | |
|-----------|-----------------------------|---------|
| ART. 0902 | Lettere/Numeri/Stella/Croce | ↓ mm 25 |
| ART. 0903 | Lettere/Numeri/Stella/Croce | ↓ mm 30 |
| ART. 0904 | Lettere/Numeri | ↓ mm 40 |
| ART. 0905 | Lettere | ↓ mm 50 |

| | | |
|-----------|-----------------------|------------------|
| ART. 0906 | Lettere | ↓ mm 60 |
| ART. 0908 | Lettere | ↓ mm 80 |
| ART. 0909 | Punto/Virgola/Accento | x mm 25-30-40-50 |
| ART. 0909 | Trattino | x mm 25-30-40-50 |
| ART. 0910 | Punto/ Virgola | x mm 60-80 |



PORCELLANA



PORCELLANA

PORCELLANA, IL PRESTIGIO DI UNO STILE INCONFONDIBILE

É nella porcellana che la Vezzani raggiunge l'eccellenza, realizzando quella sintesi di tradizione ed innovazione che caratterizza lo stile inimitabile dei suoi prodotti. Il segreto della porcellana è nella sua forza eterea, così delicata da sembrare misteriosa, eppure destinata a testimoniare nei secoli la serietà di un'azienda, la professionalità e l'impegno degli uomini che l'hanno resa famosa nel mondo.

PORCELAIN, THE PRESTIGE OF UNMISTAKABLE ELEGANCE

Vezzani have achieved levels of excellence with porcelain, producing a synthesis of tradition and innovation that characterizes the inimitable style of its products. Porcelain's secret is in its ethereal power, so delicate as to appear mysterious, but destined throughout the centuries to prove the sincerity of a company, the professional know-how and commitment of the personnel that have made it famous worldwide.



La Vezzani S.p.A. è la prima e la più importante azienda del settore che può vantare il primato del rilancio della tradizione millenaria della porcellana sul mercato funerario internazionale, in sintonia con le esigenze moderne grazie ai più avanzati ritrovati dell'arte e della tecnica.

La Vezzani s.p.a. è in condizione di comunicare alla propria clientela che all'altissima qualità della propria linea di prodotti di porcellana consegue la sua sostanziale inalterabilità nel tempo, e in particolare, la sua resistenza al sole, al gelo, alla salsedine, alle piogge acide e a tutte le forme di inquinamento.

Una qualità che l'operatore del settore potrà a propria volta rendere nota al suo cliente, qualificando così il proprio lavoro con un prodotto che non porrà problemi perché praticamente eterno, salvo invecchiamento naturale dei particolari metallici e degli eventuali decori. La Vezzani s.p.a. di buon grado rilascia per iscritto tale attestazione alla propria clientela, che le ha permesso, concedendole la sua fiducia, di diventare l'azienda leader nel mondo in tale settore.

Con gratitudine.

Vezzani s.p.a. is the sector's most important company and the first able to boast leadership on the international funerary market with the revival of the age-old tradition of porcelain, in step with modern demands thanks to the most advanced discoveries in art and technology.

Vezzani s.p.a. is able to inform its customers that its line of porcelain products is of the highest quality making it essentially unalterable over time and, in particular, resistant to the sun, frost, salt, acid rain, and all form of pollution.

A quality that sector operators may in turn make known to their customers, characterizing their work with a product that will not create problems because, except for the natural ageing of the metal parts and any decorations, its practically eternal. Vezzani s.p.a. takes pleasure in providing this written statement to its customers, whose trust has allowed it to become this sector's world leader.

Many thanks.





P. 319
COLLEZIONE **PERLAGE**



P. 330
SERIE **ANIMA**



P. 336
SERIE **DEDALO**



P. 404
SERIE **LIVERPOOL**



P. 406
SERIE **AURA**



P. 408
SERIE **VOLO**



P. 342
SERIE **ETHOS**



P. 350
SERIE **ORIGINAL**



P. 356
SERIE **IDEAL**



P. 412
SERIE **ETRURIA**



P. 414
SERIE **SORRENTO**



P. 416
SERIE **SPINNAKER**



P. 360
SERIE **RAIN**



P. 362
SERIE **DUCALE**



P. 366
SERIE **HAITI**



P. 418
SERIE **GRANADA**



P. 420
SERIE **POSITANO**



P. 422
SERIE **TAORMINA**



P. 370
SERIE **NETTUNO**



P. 376
SERIE **AMADEUS**



P. 380
SERIE **FIRENZE**



P. 422
SERIE **OSTUNI**



P. 422
SERIE **ODEON**



P. 422
SERIE **AMALFI**



P. 388
SERIE **LONDON**



P. 396
SERIE **ITACA**



P. 402
SERIE **GARDEN**



COLLEZIONE **PERLAGE**

NOVITÀ

NOVITÀ

PORCELLANA



ART. 27420BP P ↓ 21 ↔ 11 cm
 ART. 27421BP I ↓ 21 ↔ 11 cm
 ART. 27283BP P T ↓ 21 ↔ 11 cm
 ART. 27284BP I ↓ 21 ↔ 11 cm
 ART. 27537BP P ↓ 28 ↔ 16 cm
 ART. 27536BP I ↓ 28 ↔ 16 cm

ART. 27420IP P ↓ 21 ↔ 11 cm
 ART. 27421IP I ↓ 21 ↔ 11 cm
 ART. 27283IP P T ↓ 21 ↔ 11 cm
 ART. 27284IP I ↓ 21 ↔ 11 cm
 ART. 27537IP P ↓ 28 ↔ 16 cm
 ART. 27536IP I ↓ 28 ↔ 16 cm



ART. 29495BP P ↓ 18,5 ↔ 17 cm
 ART. 29496BP R/C ↓ 18,5 ↔ 17 cm
 ART. 29606BP P T ↓ 18,5 ↔ 17 cm
 ART. 29607BP R/C ↓ 18,5 ↔ 17 cm

ART. 29495IP P ↓ 18,5 ↔ 17 cm
 ART. 29496IP R/C ↓ 18,5 ↔ 17 cm
 ART. 29606IP P T ↓ 18,5 ↔ 17 cm
 ART. 29607IP R/C ↓ 18,5 ↔ 17 cm



ART. 27476BP P ↓ 11 ↔ 7 cm
 ART. 27624BP P ↓ 13 ↔ 8 cm
 ART. 27623BP R/C ↓ 13 ↔ 8 cm
 ART. 27579BP P T ↓ 13 ↔ 8 cm
 ART. 27578BP R/C ↓ 13 ↔ 8 cm

ART. 26421BP Ø 5 P ↓ 21 ↔ 8,5 cm
 ART. 26102BP Ø 5 T ↓ 21 ↔ 8,5 cm
 ART. 26616BP Ø 4 P ↓ 13 ↔ 7 cm
 ART. 26150BP Ø 4 T ↓ 13 ↔ 7 cm

ART. 26616IP Ø 4 P ↓ 13 ↔ 7 cm
 ART. 26150IP Ø 4 T ↓ 13 ↔ 7 cm
 ART. 26421IP Ø 5 P ↓ 21 ↔ 8,5 cm
 ART. 26102IP Ø 5 T ↓ 21 ↔ 8,5 cm

ART. 27476IP P ↓ 11 ↔ 7 cm
 ART. 27624IP P ↓ 13 ↔ 8 cm
 ART. 27623IP R/C ↓ 13 ↔ 8 cm
 ART. 27579IP P T ↓ 13 ↔ 8 cm
 ART. 27578IP R/C ↓ 13 ↔ 8 cm



ART. 20158BP 7x9 cm
 ART. 20159BP 8x10 cm
 ART. 20155BP 9x12 cm
 ART. 20156BP 11x15 cm
 ART. 20157BP 13x18 cm

ART. 20166BP 9x12 cm
 ART. 20167BP 10x15 cm
 ART. 20168BP 11x15 cm
 ART. 20169BP 13x18 cm

ART. 24025BP ↓ 10 ↔ 6 cm
 ART. 24026BP ↓ 15 ↔ 9 cm
 ART. 24027BP ↓ 20 ↔ 11 cm
 ART. 24028BP ↓ 30 ↔ 14 cm
 ART. 24029BP ↓ 40 ↔ 15 cm

ART. 20158IP 7x9 cm
 ART. 20159IP 8x10 cm
 ART. 20155IP 9x12 cm
 ART. 20156IP 11x15 cm
 ART. 20157IP 13x18 cm

ART. 20166IP 9x12 cm
 ART. 20167IP 10x15 cm
 ART. 20168IP 11x15 cm
 ART. 20169IP 13x18 cm

ART. 24025IP ↓ 10 ↔ 6 cm
 ART. 24026IP ↓ 15 ↔ 9 cm
 ART. 24027IP ↓ 20 ↔ 11 cm
 ART. 24028IP ↓ 30 ↔ 14 cm
 ART. 24029IP ↓ 40 ↔ 15 cm

Essendo un prodotto lavorato manualmente, può presentare differenze di colore.
 Being a manually processed product, there may be differences in colour.

Essendo un prodotto lavorato manualmente, può presentare differenze di colore.
 Being a manually processed product, there may be differences in colour.



ART. 27410BP P
↓ 20 ↔ 12,5 cm

ART. 27262BP P T
↓ 20 ↔ 12,5 cm

ART. 27410IP P
↓ 20 ↔ 12,5 cm

ART. 27262IP P T
↓ 20 ↔ 12,5 cm

ART. 27411BP I
↓ 20 ↔ 12,5 cm

ART. 27263BP I
↓ 20 ↔ 12,5 cm

ART. 27411IP I
↓ 20 ↔ 12,5 cm

ART. 27263IP I
↓ 20 ↔ 12,5 cm



ART. 29390BP P
↓ 18 ↔ 17 cm

ART. 29590BP P T
↓ 18 ↔ 17 cm

ART. 26415BP Ø 5 P
↓ 21 ↔ 9,5 cm

ART. 26415IP Ø 5 P
↓ 21 ↔ 9,5 cm

ART. 29390IP P
↓ 18 ↔ 17 cm

ART. 29590IP P T
↓ 18 ↔ 17 cm

ART. 29399BP R/C
↓ 18 ↔ 17 cm

ART. 29591BP R/C
↓ 18 ↔ 17 cm

ART. 26162BP Ø 5 T
↓ 21 ↔ 9,5 cm

ART. 26162IP Ø 5 T
↓ 21 ↔ 9,5 cm

ART. 29399IP R/C
↓ 18 ↔ 17 cm

ART. 29591IP R/C
↓ 18 ↔ 17 cm



ART. 20153BP 7x9 cm
ART. 20154BP 8x10 cm
ART. 20263BP 9x12 cm
ART. 20264BP 11x15 cm
ART. 20265BP 13x18 cm

ART. 20323BP 7x9 cm
ART. 20324BP 8x10 cm
ART. 20345BP 9x12 cm
ART. 20346BP 10x15 cm
ART. 20347BP 11x15 cm
ART. 20348BP 13x18 cm

ART. 20153IP 7x9 cm
ART. 20154IP 8x10 cm
ART. 20263IP 9x12 cm
ART. 20264IP 11x15 cm
ART. 20265IP 13x18 cm

ART. 20323IP 7x9 cm
ART. 20324IP 8x10 cm
ART. 20345IP 9x12 cm
ART. 20346IP 10x15 cm
ART. 20347IP 11x15 cm
ART. 20348IP 13x18 cm

Essendo un prodotto lavorato manualmente, può presentare differenze di colore.
Being a manually processed product, there may be differences in colour.

Essendo un prodotto lavorato manualmente, può presentare differenze di colore.
Being a manually processed product, there may be differences in colour.

NOVITÀ

NOVITÀ



PORCELLANA



ART. 21279BP P
↓ 21 ↔ 12 cm

ART. 21092BP P T
↓ 21 ↔ 12 cm

ART. 21279IP P
↓ 21 ↔ 12 cm

ART. 21092IP P T
↓ 21 ↔ 12 cm

ART. 21297BP P
↓ 14 ↔ 8 cm

ART. 21111BP P
↓ 14 ↔ 8 cm

ART. 21297IP P
↓ 14 ↔ 8 cm

ART. 21111IP P
↓ 14 ↔ 8 cm

ART. 21299BP P
↓ 12 ↔ 6,5 cm

ART. 21299IP P
↓ 12 ↔ 6,5 cm



ART. 29880BP P
↓ 19 ↔ 18 cm

ART. 29728BP P T
↓ 19 ↔ 18 cm

ART. 22207BP Ø 5 P
↓ 19 ↔ 9 cm

ART. 22004BP Ø 5 T
↓ 19 ↔ 9 cm

ART. 22207IP Ø 5 P
↓ 19 ↔ 9 cm

ART. 22004IP Ø 5 T
↓ 19 ↔ 9 cm

ART. 29880IP P
↓ 19 ↔ 18 cm

ART. 29728IP P T
↓ 19 ↔ 18 cm

ART. 22297BP Ø 4
↓ 14 ↔ 7,5 cm

ART. 22110BP Ø 4
↓ 14 ↔ 7,5 cm

ART. 22297IP Ø 4
↓ 14 ↔ 7,5 cm

ART. 22110IP Ø 4
↓ 14 ↔ 7,5 cm



ART. 200127BP 9x12 cm
ART. 200128BP 11x15 cm
ART. 200129BP 13x18 cm

ART. 200130BP 9x12 cm
ART. 200132BP 11x15 cm
ART. 200133BP 13x18 cm

ART. 200127IP 9x12 cm
ART. 200128IP 11x15 cm
ART. 200129IP 13x18 cm

ART. 200130IP 9x12 cm
ART. 200132IP 11x15 cm
ART. 200133IP 13x18 cm

Essendo un prodotto lavorato manualmente, può presentare differenze di colore.
Being a manually processed product, there may be differences in colour.

Essendo un prodotto lavorato manualmente, può presentare differenze di colore.
Being a manually processed product, there may be differences in colour.

NOVITÀ

Vezzani

BIANCO PERLATO

| | | |
|-------------|-----------------------------|---------|
| ART. 5955BP | Lettere | ↓ mm 55 |
| ART. 5930BP | Lettere/Numeri/Stella/Croce | ↓ mm 30 |
| ART. 5985BP | Pax | ↓ mm 55 |

| | | |
|-------------|----------|---------|
| ART. 5992BP | Accento | ↓ mm 30 |
| ART. 5996BP | Trattino | ↓ mm 30 |
| ART. 5997BP | Virgola | ↓ mm 30 |
| ART. 5999BP | Punto | ↓ mm 30 |

NOVITÀ

VEZZANI

BIANCO PERLATO CON PERNO

| | | |
|-------------|-----------------------------|---------|
| ART. 5934BP | Lettere/Numeri/Stella/Croce | ↓ mm 30 |
| ART. 5944BP | Lettere/Numeri/Stella/Croce | ↓ mm 40 |
| ART. 5954BP | Lettere/Numeri/Stella/Croce | ↓ mm 50 |

| | | |
|-------------|---------------------------------------|---------|
| ART. 5967BP | Punto/Accento/Virgola per mm 30-40-50 | |
| ART. 5967BP | Trattino | ↓ mm 30 |

Vezzani

SMALTO BIANCO PERLATO

| | | |
|---------------|-----------------------------|---------|
| ART. 5955BPSB | Lettere | ↓ mm 55 |
| ART. 5930BPSB | Lettere/Numeri/Stella/Croce | ↓ mm 30 |
| ART. 5985BPSB | Pax | ↓ mm 55 |

| | | |
|---------------|----------|---------|
| ART. 5992BPSB | Accento | ↓ mm 30 |
| ART. 5996BPSB | Trattino | ↓ mm 30 |
| ART. 5997BPSB | Virgola | ↓ mm 30 |
| ART. 5999BPSB | Punto | ↓ mm 30 |

SMALTO BIANCO PERLATO CON PERNO

| | | |
|---------------|-----------------------------|---------|
| ART. 5934BPSB | Lettere/Numeri/Stella/Croce | ↓ mm 30 |
| ART. 5944BPSB | Lettere/Numeri/Stella/Croce | ↓ mm 40 |
| ART. 5954BPSB | Lettere/Numeri/Stella/Croce | ↓ mm 50 |

| | | |
|---------------|---------------------------------------|---------|
| ART. 5967BPSB | Punto/Accento/Virgola per mm 30-40-50 | |
| ART. 5967BPSB | Trattino | ↓ mm 30 |

ARCADIA IVORY PERLATO

NOVITÀ

Vezzani

IVORY PERLATO

| | | |
|-------------|-----------------------------|---------|
| ART. 5901IP | Lettere | ↓ mm 55 |
| ART. 5900IP | Lettere/Numeri/Stella/Croce | ↓ mm 30 |
| ART. 5987IP | Pax | ↓ mm 55 |
| ART. 5907IP | Accento | ↓ mm 30 |
| ART. 5906IP | Trattino | ↓ mm 30 |
| ART. 5908IP | Virgola | ↓ mm 30 |
| ART. 5909IP | Punto | ↓ mm 30 |

MISTRAL IVORY PERLATO

NOVITÀ

VEZZANI

IVORY PERLATO CON PERNO

| | | |
|-------------|---------------------------------------|---------|
| ART. 5934IP | Lettere/Numeri/Stella/Croce | ↓ mm 30 |
| ART. 5944IP | Lettere/Numeri/Stella/Croce | ↓ mm 40 |
| ART. 5954IP | Lettere/Numeri/Stella/Croce | ↓ mm 50 |
| ART. 5967IP | Punto/Accento/Virgola per mm 30-40-50 | |
| ART. 5967IP | Trattino | ↓ mm 30 |

Essendo un prodotto lavorato manualmente, può presentare differenze di colore.
Being a manually processed product, there may be differences in colour.

Essendo un prodotto lavorato manualmente, può presentare differenze di colore.
Being a manually processed product, there may be differences in colour.

LA SOLUZIONE PER RENDERE UNICO IL RICORDO

Le Serie in porcellana Vezzani possono essere richieste nelle seguenti colorazioni.
Per ordinazioni aggiungere al codice articolo la lettera corrispondente alla colorazione scelta.

*Porcelain Series Vezzani are available in the following colours.
To peaces orders add to the product code the letter corresponding the selected coloury.*



Porcellana bianca con inserti in acciaio inox 18/10



ART. 27420 P
↓ 21 ↔ 11 cm

ART. 27421 I
↓ 21 ↔ 11 cm

ART. 27283 P T
↓ 21 ↔ 11 cm

ART. 27284 I
↓ 21 ↔ 11 cm

ART. 27537 P
↓ 28 ↔ 16 cm

ART. 27536 I
↓ 28 ↔ 16 cm

ART. 27476 P
↓ 11 ↔ 7 cm

ART. 27624 P
↓ 13 ↔ 8 cm

ART. 27623 R/C
↓ 13 ↔ 8 cm

ART. 27579 P T
↓ 13 ↔ 8 cm

ART. 27578 R/C
↓ 13 ↔ 8 cm



ART. 29495 P
↓ 18,5 ↔ 17 cm

ART. 29496 R/C
↓ 18,5 ↔ 17 cm

ART. 29606 P T
↓ 18,5 ↔ 17 cm

ART. 29607 R/C
↓ 18,5 ↔ 17 cm



ART. 29782 T
senza interno
↓ 11 ↔ 19 cm

ART. 29783
senza interno
↓ 7 ↔ 13 cm

ART. 29780 P T
interno alluminio
↓ 14,5 ↔ 18 cm



ART. 26421 Ø 5 P
↓ 21 ↔ 8,5 cm

ART. 26102 Ø 5 T
↓ 21 ↔ 8,5 cm



ART. 26616 Ø 4 P
↓ 13 ↔ 7 cm

ART. 26150 Ø 4 T
↓ 13 ↔ 7 cm



ART. 20158 7x9 cm
ART. 20159 8x10 cm
ART. 20155 9x12 cm
ART. 20156 11x15 cm
ART. 20157 13x18 cm



ART. 20166 9x12 cm
ART. 20167 10x15 cm
ART. 20168 11x15 cm
ART. 20169 13x18 cm



ART. 24025 ↓ 10 ↔ 6 cm
ART. 24026 ↓ 15 ↔ 9 cm
ART. 24027 ↓ 20 ↔ 11 cm
ART. 24028 ↓ 30 ↔ 14 cm
ART. 24029 ↓ 40 ↔ 15 cm

PORCELLANA

Porcellana marmorizzata con inserti in acciaio inox 18/10

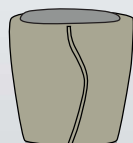

ART. 27420 P
↓ 21 ↔ 11 cm

ART. 27283 P T
↓ 21 ↔ 11 cm

ART. 29495 P P
↓ 18,5 ↔ 17 cm

ART. 29606 P T
↓ 18,5 ↔ 17 cm

ART. 26421 Ø 5 P
↓ 21 ↔ 8,5 cm

ART. 26616 Ø 4 P
↓ 13 ↔ 7 cm

ART. 27421 I
↓ 21 ↔ 11 cm

ART. 27284 I
↓ 21 ↔ 11 cm

ART. 29496 R/C
↓ 18,5 ↔ 17 cm

ART. 29607 R/C
↓ 18,5 ↔ 17 cm

ART. 26102 Ø 5 T
↓ 21 ↔ 8,5 cm

ART. 26150 Ø 4 T
↓ 13 ↔ 7 cm

ART. 27537 P
↓ 28 ↔ 16 cm

ART. 27536 I
↓ 28 ↔ 16 cm



ART. 27476 P P
↓ 11 ↔ 7 cm
ART. 27624 P
↓ 13 ↔ 8 cm
ART. 27623 R/C
↓ 13 ↔ 8 cm

ART. 27579 P T
↓ 13 ↔ 8 cm
ART. 27578 R/C
↓ 13 ↔ 8 cm

ART. 20158 7x9 cm
ART. 20159 8x10 cm
ART. 20155 9x12 cm
ART. 20156 11x15 cm
ART. 20157 13x18 cm

ART. 20166 9x12 cm
ART. 20167 10x15 cm
ART. 20168 11x15 cm
ART. 20169 13x18 cm

ART. 24025 ↓ 10 ↔ 6 cm
ART. 24026 ↓ 15 ↔ 9 cm
ART. 24027 ↓ 20 ↔ 11 cm
ART. 24028 ↓ 30 ↔ 14 cm
ART. 24029 ↓ 40 ↔ 15 cm

Per ordinazioni aggiungere al codice articolo la sigla corrispondente alla colorazione scelta, To place orders add to the article code the letter corresponding the selected colouring.



Sahara Yellow + Verona con inserti in acciaio inox 18/10



Carrara + Verde Guatemala con inserti in acciaio inox 18/10



P ART. 27424 P ↓ 21 ↔ 11 cm
ART. 27425 I ↓ 21 ↔ 11 cm
T ART. 27288 P ↓ 21 ↔ 11 cm
ART. 27297 I ↓ 21 ↔ 11 cm
ART. 27551 P ↓ 28 ↔ 16 cm
ART. 27550 I ↓ 28 ↔ 16 cm



P ART. 27483 P ↓ 11 ↔ 7 cm
ART. 27628 P ↓ 13 ↔ 8 cm
ART. 27627 R/C ↓ 13 ↔ 8 cm
T ART. 27585 P ↓ 13 ↔ 8 cm
ART. 27584 R/C ↓ 13 ↔ 8 cm



P ART. 29499 P ↓ 18,5 ↔ 17 cm
ART. 29514 R/C ↓ 18,5 ↔ 17 cm
T ART. 29610 P ↓ 18,5 ↔ 17 cm
ART. 29611 R/C ↓ 18,5 ↔ 17 cm



P ART. 26424 Ø 5 ↓ 21 ↔ 8,5 cm
T ART. 26107 Ø 5 ↓ 21 ↔ 8,5 cm



P ART. 26618 Ø 4 ↓ 13 ↔ 7 cm
T ART. 26180 Ø 4 ↓ 13 ↔ 7 cm



ART. 200095 7x9 cm
ART. 200096 8x10 cm
ART. 200097 9x12 cm
ART. 200098 11x15 cm
ART. 200099 13x18 cm



ART. 200100 9x12 cm
ART. 200101 10x15 cm
ART. 200102 11x15 cm
ART. 200103 13x18 cm



ART. 24364 ↓ 10 ↔ 6 cm
ART. 24365 ↓ 15 ↔ 9 cm
ART. 24366 ↓ 20 ↔ 11 cm
ART. 24367 ↓ 30 ↔ 14 cm
ART. 24368 ↓ 40 ↔ 15 cm



P ART. 27426 P ↓ 21 ↔ 11 cm
ART. 27427 I ↓ 21 ↔ 11 cm
T ART. 27298 P ↓ 21 ↔ 11 cm
ART. 27299 I ↓ 21 ↔ 11 cm
ART. 27553 P ↓ 28 ↔ 16 cm
ART. 27552 I ↓ 28 ↔ 16 cm



P ART. 27484 P ↓ 11 ↔ 7 cm
ART. 27630 P ↓ 13 ↔ 8 cm
ART. 27629 R/C ↓ 13 ↔ 8 cm
T ART. 27587 P ↓ 13 ↔ 8 cm
ART. 27586 R/C ↓ 13 ↔ 8 cm



P ART. 29517 P ↓ 18,5 ↔ 17 cm
ART. 29523 R/C ↓ 18,5 ↔ 17 cm
T ART. 29612 P ↓ 18,5 ↔ 17 cm
ART. 29613 R/C ↓ 18,5 ↔ 17 cm



P ART. 26425 Ø 5 ↓ 21 ↔ 8,5 cm
T ART. 26108 Ø 5 ↓ 21 ↔ 8,5 cm



P ART. 26619 Ø 4 ↓ 13 ↔ 7 cm
T ART. 26182 Ø 4 ↓ 13 ↔ 7 cm



ART. 200104 7x9 cm
ART. 200105 8x10 cm
ART. 200106 9x12 cm
ART. 200059 11x15 cm
ART. 200060 13x18 cm



ART. 200061 9x12 cm
ART. 200062 10x15 cm
ART. 200063 11x15 cm
ART. 200064 13x18 cm



ART. 24000 ↓ 10 ↔ 6 cm
ART. 24001 ↓ 15 ↔ 9 cm
ART. 24034 ↓ 20 ↔ 11 cm
ART. 24054 ↓ 30 ↔ 14 cm
ART. 24363 ↓ 40 ↔ 15 cm

Porcellana bianca con decoro color platino



ART. 27422 P \updownarrow 21 \leftrightarrow 11 cm
 ART. 27286 P \updownarrow 21 \leftrightarrow 11 cm

ART. 27423 I \updownarrow 21 \leftrightarrow 11 cm
 ART. 27287 I \updownarrow 21 \leftrightarrow 11 cm

ART. 27549 P
 \updownarrow 28 \leftrightarrow 16 cm

ART. 27548 I
 \updownarrow 28 \leftrightarrow 16 cm



ART. 29497 P \updownarrow 18,5 \leftrightarrow 17 cm

ART. 29608 P \updownarrow 18,5 \leftrightarrow 17 cm

ART. 29498 R/C \updownarrow 18,5 \leftrightarrow 17 cm

ART. 29609 R/C \updownarrow 18,5 \leftrightarrow 17 cm



ART. 29787 I
 interno alluminio \updownarrow 14,5 \leftrightarrow 18 cm

ART. 27482 P \updownarrow 11 \leftrightarrow 7 cm

ART. 27583 P \updownarrow 13 \leftrightarrow 8 cm

ART. 27626 P \updownarrow 13 \leftrightarrow 8 cm

ART. 27582 R/C \updownarrow 13 \leftrightarrow 8 cm

ART. 27625 R/C \updownarrow 13 \leftrightarrow 8 cm



ART. 26617 \varnothing 4 \updownarrow 13 \leftrightarrow 7 cm

ART. 26423 \varnothing 5 \updownarrow 21 \leftrightarrow 8,5 cm

ART. 26153 \varnothing 4 \updownarrow 13 \leftrightarrow 7 cm

ART. 26104 \varnothing 5 \updownarrow 21 \leftrightarrow 8,5 cm



ART. 200065 7x9 cm
 ART. 200066 8x10 cm
 ART. 200067 9x12 cm
 ART. 200068 11x15 cm
 ART. 200069 13x18 cm



ART. 200070 9x12 cm
 ART. 200071 10x15 cm
 ART. 200072 11x15 cm
 ART. 200073 13x18 cm



ART. 24369 \updownarrow 10 \leftrightarrow 6 cm
 ART. 24370 \updownarrow 15 \leftrightarrow 9 cm
 ART. 24371 \updownarrow 20 \leftrightarrow 11 cm
 ART. 24372 \updownarrow 30 \leftrightarrow 14 cm
 ART. 24373 \updownarrow 40 \leftrightarrow 15 cm



Porcellana bianca
 con decoro color oro



Porcellana ivory con
 decoro color oro

ART. 27658 P \updownarrow 21 \leftrightarrow 11 cm
 ART. 27659 R \updownarrow 21 \leftrightarrow 11 cm

ART. 27704 P \updownarrow 21 \leftrightarrow 11 cm
 ART. 27706 R \updownarrow 21 \leftrightarrow 11 cm

ART. 27700 P \updownarrow 28 \leftrightarrow 16 cm
 ART. 27702 R \updownarrow 28 \leftrightarrow 16 cm



ART. 27663 P \updownarrow 21 \leftrightarrow 11 cm
 ART. 27664 R \updownarrow 21 \leftrightarrow 11 cm

ART. 27712 P \updownarrow 21 \leftrightarrow 11 cm
 ART. 27713 R \updownarrow 21 \leftrightarrow 11 cm

ART. 27709 P \updownarrow 28 \leftrightarrow 16 cm
 ART. 27710 R \updownarrow 28 \leftrightarrow 16 cm



ART. 27662 P \updownarrow 11 \leftrightarrow 8 cm
 ART. 27660 P \updownarrow 13 \leftrightarrow 7 cm

ART. 27661 R \updownarrow 13 \leftrightarrow 8 cm

ART. 27707 P \updownarrow 13 \leftrightarrow 8 cm
 ART. 27708 R \updownarrow 13 \leftrightarrow 8 cm



ART. 27667 P \updownarrow 11 \leftrightarrow 7 cm
 ART. 27665 P \updownarrow 13 \leftrightarrow 8 cm

ART. 27666 R \updownarrow 13 \leftrightarrow 8 cm

ART. 27714 P \updownarrow 13 \leftrightarrow 8 cm
 ART. 27715 R \updownarrow 13 \leftrightarrow 8 cm



ART. 29873 P \updownarrow 18,5 \leftrightarrow 17 cm
 ART. 29874 R \updownarrow 18,5 \leftrightarrow 17 cm

ART. 29731 P \updownarrow 18,5 \leftrightarrow 17 cm
 ART. 29732 R \updownarrow 18,5 \leftrightarrow 17 cm



ART. 29875 P \updownarrow 18,5 \leftrightarrow 17 cm
 ART. 29876 R \updownarrow 18,5 \leftrightarrow 17 cm

ART. 29733 P \updownarrow 18,5 \leftrightarrow 17 cm
 ART. 29734 R \updownarrow 18,5 \leftrightarrow 17 cm



ART. 29788 I
 interno alluminio \updownarrow 14,5 \leftrightarrow 18 cm

ART. 29789 I
 interno alluminio \updownarrow 14,5 \leftrightarrow 18 cm



ART. 26435 \varnothing 5 \updownarrow 21 \leftrightarrow 8,5 cm

ART. 26045 \varnothing 5 \updownarrow 21 \leftrightarrow 8,5 cm



ART. 26445 \varnothing 5 \updownarrow 21 \leftrightarrow 8,5 cm

ART. 26053 \varnothing 5 \updownarrow 21 \leftrightarrow 8,5 cm



ART. 26433 \varnothing 4 \updownarrow 13 \leftrightarrow 7 cm

ART. 26039 \varnothing 4 \updownarrow 13 \leftrightarrow 7 cm



ART. 26444 \varnothing 4 \updownarrow 13 \leftrightarrow 7 cm

ART. 26049 \varnothing 4 \updownarrow 13 \leftrightarrow 7 cm



ART. 200107 7x9 cm

ART. 200108 8x10 cm

ART. 200109 9x12 cm

ART. 200110 11x15 cm

ART. 200111 13x18 cm



ART. 200116 7x9 cm

ART. 200117 8x10 cm

ART. 200118 9x12 cm

ART. 200119 11x15 cm

ART. 200120 13x18 cm



ART. 200112 9x12 cm

ART. 200113 10x15 cm

ART. 200114 11x15 cm

ART. 200115 13x18 cm



ART. 200121 9x12 cm

ART. 200122 10x15 cm

ART. 200123 11x15 cm

ART. 200124 13x18 cm



ART. 24378 \updownarrow 10 \leftrightarrow 6 cm

ART. 24379 \updownarrow 15 \leftrightarrow 9 cm

ART. 24380 \updownarrow 20 \leftrightarrow 11 cm

ART. 24381 \updownarrow 30 \leftrightarrow 14 cm

ART. 24382 \updownarrow 40 \leftrightarrow 15 cm



ART. 24383 \updownarrow 10 \leftrightarrow 6 cm

ART. 24384 \updownarrow 15 \leftrightarrow 9 cm

ART. 24385 \updownarrow 20 \leftrightarrow 11 cm

ART. 24386 \updownarrow 30 \leftrightarrow 14 cm

ART. 24387 \updownarrow 40 \leftrightarrow 15 cm



Si informa che la colorazione platino contiene particelle metalliche quindi potrebbe subire piccole alterazioni di colore nel tempo.
 We inform you that platinum contains metal particles so it could change a little its colour in time.

Porcellana bianca con inserti in acciaio inox 18/10



ART. 27449 P
↓ 21 ↔ 11 cm

ART. 27450 I
↓ 21 ↔ 11 cm

ART. 27520 P T
↓ 21 ↔ 11 cm

ART. 27521 I
↓ 21 ↔ 11 cm

ART. 27535 P
↓ 28 ↔ 16 cm

ART. 27534 I
↓ 28 ↔ 16 cm

ART. 27475 P
↓ 11 ↔ 7 cm

ART. 27607 P
↓ 13 ↔ 8 cm

ART. 27606 R/C
↓ 13 ↔ 8 cm



ART. 27565 P T
↓ 13 ↔ 8 cm

ART. 27564 R/C
↓ 13 ↔ 8 cm



ART. 29556 P
↓ 18,5 ↔ 17 cm

ART. 29561 R/C
↓ 18,5 ↔ 17 cm

ART. 29626 P T
↓ 18,5 ↔ 17 cm

ART. 29627 R/C
↓ 18,5 ↔ 17 cm



ART. 26438 Ø 5 P
↓ 21 ↔ 9 cm

ART. 26115 Ø 5 T
↓ 21 ↔ 9 cm



ART. 26601 Ø 4 P
↓ 13 ↔ 7,5 cm

ART. 26144 Ø 4 T
↓ 13 ↔ 7,5 cm



ART. 20158 7x9 cm
ART. 20159 8x10 cm
ART. 20155 9x12 cm
ART. 20156 11x15 cm
ART. 20157 13x18 cm



ART. 20166 9x12 cm
ART. 20167 10x15 cm
ART. 20168 11x15 cm
ART. 20169 13x18 cm



ART. 24025 ↓ 10 ↔ 6 cm
ART. 24026 ↓ 15 ↔ 9 cm
ART. 24027 ↓ 20 ↔ 11 cm
ART. 24028 ↓ 30 ↔ 14 cm
ART. 24029 ↓ 40 ↔ 15 cm

PORCELLANA

Porcellana marmorizzata con inserti in acciaio inox 18/10

Porcellana bianca con decoro color platino e inserti in acciaio inox 18/10



PORCELLANA

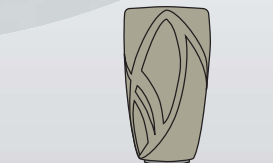

ART. 27449 P
↓ 21 ↔ 11 cm

ART. 27520 P
↓ 21 ↔ 11 cm

ART. 29556 P
↓ 18,5 ↔ 17 cm

ART. 29626 P
↓ 18,5 ↔ 17 cm

ART. 26438 Ø 5
↓ 21 ↔ 9 cm

ART. 26601 Ø 4
↓ 13 ↔ 7,5 cm

ART. 27450 I
↓ 21 ↔ 11 cm

ART. 27521 I
↓ 21 ↔ 11 cm

ART. 29561 R/C
↓ 18,5 ↔ 17 cm

ART. 29627 R/C
↓ 18,5 ↔ 17 cm

ART. 26115 Ø 5
↓ 21 ↔ 9 cm

ART. 26144 Ø 4
↓ 13 ↔ 7,5 cm

ART. 27535 P
↓ 28 ↔ 16 cm

ART. 27534 I
↓ 28 ↔ 16 cm

ART. 27475 P
↓ 11 ↔ 7 cm

ART. 27565 P
↓ 13 ↔ 8 cm

ART. 20158 7x9 cm
ART. 20159 8x10 cm
ART. 20155 9x12 cm
ART. 20156 11x15 cm
ART. 20157 13x18 cm

ART. 20166 9x12 cm
ART. 20167 10x15 cm
ART. 20168 11x15 cm
ART. 20169 13x18 cm

ART. 24025 ↓ 10 ↔ 6 cm
ART. 24026 ↓ 15 ↔ 9 cm
ART. 24027 ↓ 20 ↔ 11 cm
ART. 24028 ↓ 30 ↔ 14 cm
ART. 24029 ↓ 40 ↔ 15 cm

ART. 27606 R/C
↓ 13 ↔ 8 cm

ART. 27607 P
↓ 13 ↔ 8 cm

ART. 27564 R/C
↓ 13 ↔ 8 cm

Per ordinazioni aggiungere al codice articolo la sigla corrispondente alla colorazione scelta.
To place orders add to the article code the letter corresponding the selected colouring.



ART. 26603 Ø 4
↓ 13 ↔ 7,5 cm

ART. 26439 Ø 5
↓ 21 ↔ 9 cm

ART. 29564 P
↓ 18,5 ↔ 17 cm

ART. 29628 P
↓ 18,5 ↔ 17 cm

ART. 26145 Ø 4
↓ 13 ↔ 7,5 cm

ART. 26117 Ø 5
↓ 21 ↔ 9 cm

ART. 29565 R/C
↓ 18,5 ↔ 17 cm

ART. 29629 R/C
↓ 18,5 ↔ 17 cm



ART. 27477 P
↓ 11 ↔ 7 cm

ART. 27569 P
↓ 13 ↔ 8 cm

ART. 200065 7x9 cm
ART. 200066 8x10 cm
ART. 200067 9x12 cm
ART. 200068 11x15 cm
ART. 200069 13x18 cm

ART. 200070 9x12 cm
ART. 200071 10x15 cm
ART. 200072 11x15 cm
ART. 200073 13x18 cm

ART. 24369 ↓ 10 ↔ 6 cm
ART. 24370 ↓ 15 ↔ 9 cm
ART. 24371 ↓ 20 ↔ 11 cm
ART. 24372 ↓ 30 ↔ 14 cm
ART. 24373 ↓ 40 ↔ 15 cm

ART. 27609 R/C
↓ 13 ↔ 8 cm

Per ordinazioni aggiungere al codice articolo la sigla corrispondente alla colorazione scelta.
To place orders add to the article code the letter corresponding the selected colouring.



Porcellana Carrara + Verde Guatemala con inserti in acciaio inox 18/10



Porcellana Sahara Yellow + Verona e inserti in acciaio inox 18/10

- P** ART. 27471 P ↓ 21 ↔ 11 cm
- ART. 27473 I ↓ 21 ↔ 11 cm
- T** ART. 27530 P ↓ 21 ↔ 11 cm
- ART. 27531 I ↓ 21 ↔ 11 cm
- ART. 27545 P ↓ 28 ↔ 16 cm
- ART. 27544 I ↓ 28 ↔ 16 cm

- P** ART. 27480 P ↓ 11 ↔ 7 cm
- ART. 27620 P ↓ 13 ↔ 8 cm
- ART. 27619 R/C ↓ 13 ↔ 8 cm
- T** ART. 27575 P ↓ 13 ↔ 8 cm
- ART. 27574 R/C ↓ 13 ↔ 8 cm

- P** ART. 29572 P ↓ 18,5 ↔ 17 cm
- ART. 29573 R/C ↓ 18,5 ↔ 17 cm
- T** ART. 29637 P ↓ 18,5 ↔ 17 cm
- ART. 29638 R/C ↓ 18,5 ↔ 17 cm

- P** ART. 26443 Ø 5 ↓ 21 ↔ 9 cm
- T** ART. 26123 Ø 5 ↓ 21 ↔ 9 cm

- P** ART. 26613 Ø 4 ↓ 13 ↔ 7,5 cm
- T** ART. 26148 Ø 4 ↓ 13 ↔ 7,5 cm

- ART. 200104 7x9 cm
- ART. 200105 8x10 cm
- ART. 200106 9x12 cm
- ART. 200059 11x15 cm
- ART. 200060 13x18 cm

- ART. 200061 9x12 cm
- ART. 200062 10x15 cm
- ART. 200063 11x15 cm
- ART. 200064 13x18 cm

- ART. 24000 ↓ 10 ↔ 6 cm
- ART. 24001 ↓ 15 ↔ 9 cm
- ART. 24034 ↓ 20 ↔ 11 cm
- ART. 24054 ↓ 30 ↔ 14 cm
- ART. 24363 ↓ 40 ↔ 15 cm

- P** ART. 27467 P ↓ 21 ↔ 11 cm
- ART. 27470 I ↓ 21 ↔ 11 cm
- T** ART. 27528 P ↓ 21 ↔ 11 cm
- ART. 27529 I ↓ 21 ↔ 11 cm
- ART. 27547 P ↓ 28 ↔ 16 cm
- ART. 27546 I ↓ 28 ↔ 16 cm

- P** ART. 27481 P ↓ 11 ↔ 7 cm
- ART. 27620 P ↓ 13 ↔ 8 cm
- ART. 27621 R/C ↓ 13 ↔ 8 cm
- T** ART. 27577 P ↓ 13 ↔ 8 cm
- ART. 27576 R/C ↓ 13 ↔ 8 cm

- P** ART. 29570 P ↓ 18,5 ↔ 17 cm
- ART. 29571 R/C ↓ 18,5 ↔ 17 cm
- T** ART. 29635 P ↓ 18,5 ↔ 17 cm
- ART. 29636 R/C ↓ 18,5 ↔ 17 cm

- P** ART. 26442 Ø 5 ↓ 21 ↔ 9 cm
- T** ART. 26121 Ø 5 ↓ 21 ↔ 9 cm

- P** ART. 26614 Ø 4 ↓ 13 ↔ 7,5 cm
- T** ART. 26149 Ø 4 ↓ 13 ↔ 7,5 cm

- ART. 200095 7x9 cm
- ART. 200096 8x10 cm
- ART. 200097 9x12 cm
- ART. 200098 11x15 cm
- ART. 200099 13x18 cm

- ART. 200100 9x12 cm
- ART. 200101 10x15 cm
- ART. 200102 11x15 cm
- ART. 200103 13x18 cm

- ART. 24364 ↓ 10 ↔ 6 cm
- ART. 24365 ↓ 15 ↔ 9 cm
- ART. 24366 ↓ 20 ↔ 11 cm
- ART. 24367 ↓ 30 ↔ 14 cm
- ART. 24368 ↓ 40 ↔ 15 cm

Porcellana marmorizzata con intarsio bianco e inserti in acciaio inox 18/10



PORCELLANA

- ART. 26612 Ø 4 ↓ 13 ↔ 7,5 cm **P**
- ART. 26441 Ø 5 ↓ 21 ↔ 9 cm **P**
- ART. 29568 P ↓ 18,5 ↔ 17 cm **P**
- ART. 29633 P ↓ 18,5 ↔ 17 cm **T**
- ART. 27461 P ↓ 21 ↔ 11 cm **P**
- ART. 27526 P ↓ 21 ↔ 11 cm **T**
- ART. 26147 Ø 4 ↓ 13 ↔ 7,5 cm **T**
- ART. 26120 Ø 5 ↓ 21 ↔ 9 cm **T**
- ART. 29569 R/C ↓ 18,5 ↔ 17 cm
- ART. 29634 R/C ↓ 18,5 ↔ 17 cm
- ART. 27466 I ↓ 21 ↔ 11 cm
- ART. 27527 I ↓ 21 ↔ 11 cm
- ART. 27543 P ↓ 28 ↔ 16 cm
- ART. 27542 I ↓ 28 ↔ 16 cm
- ART. 27479 P ↓ 11 ↔ 7 cm **P**
- ART. 27573 P ↓ 13 ↔ 8 cm **T**
- ART. 20158 7x9 cm
- ART. 20159 8x10 cm
- ART. 20155 9x12 cm
- ART. 20156 11x15 cm
- ART. 20157 13x18 cm
- ART. 20166 9x12 cm
- ART. 20167 10x15 cm
- ART. 20168 11x15 cm
- ART. 20169 13x18 cm
- ART. 24025 ↓ 10 ↔ 6 cm
- ART. 24026 ↓ 15 ↔ 9 cm
- ART. 24027 ↓ 20 ↔ 11 cm
- ART. 24028 ↓ 30 ↔ 14 cm
- ART. 24029 ↓ 40 ↔ 15 cm
- ART. 27617 R/C ↓ 13 ↔ 8 cm

Per ordinazioni aggiungere al codice articolo la sigla corrispondente alla colorazione scelta.
To place orders add to the article code the letter corresponding the selected colouring.

Porcellana Bianca con inserti in acciaio inox 18/10



ART. 27428 P
↓ 21 ↔ 11 cm

ART. 27429 I
↓ 21 ↔ 11 cm

ART. 27506 P T
↓ 21 ↔ 11 cm

ART. 27507 I
↓ 21 ↔ 11 cm

ART. 27533 P
↓ 28 ↔ 16 cm

ART. 27532 I
↓ 28 ↔ 16 cm



ART. 27474 P
↓ 11 ↔ 7 cm

ART. 27632 P
↓ 13 ↔ 8 cm

ART. 27631 R/C
↓ 13 ↔ 8 cm

ART. 27589 P T
↓ 13 ↔ 8 cm

ART. 27588 R/C
↓ 13 ↔ 8 cm



ART. 29526 P
↓ 18,5 ↔ 17 cm

ART. 29533 R/C
↓ 18,5 ↔ 17 cm

ART. 29614 P T
↓ 18,5 ↔ 17 cm

ART. 29615 R/C
↓ 18,5 ↔ 17 cm



ART. 29781 P T
int. alluminio
↓ 14,5 ↔ 19 cm



ART. 26426 Ø 5 P
↓ 21 ↔ 9 cm

ART. 26109 Ø 5 T
↓ 21 ↔ 9 cm



ART. 26620 Ø 4 P
↓ 13 ↔ 7 cm

ART. 26184 Ø 4 T
↓ 13 ↔ 7 cm



ART. 20665 9x12 cm
ART. 20666 11x15 cm
ART. 20667 13x18 cm



ART. 20668 9x12 cm
ART. 20669 10x15 cm
ART. 20670 11x15 cm
ART. 20671 13x18 cm



ART. 24322 ↓ 20 ↔ 11 cm

PORCELLANA

Porcellana marmorizzata con inserti in acciaio inox 18/10

Porcellana Bianca con decoro color platino e inserti in acciaio inox 8/10



ART. 27439 P ↓ 21 ↔ 11 cm

ART. 27440 I ↓ 21 ↔ 11 cm

ART. 27508 P ↓ 21 ↔ 11 cm

ART. 27509 I ↓ 21 ↔ 11 cm

ART. 27555 P ↓ 28 ↔ 16 cm

ART. 27554 I ↓ 28 ↔ 16 cm



PORCELLANA

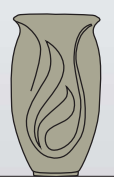

| | | | | | | | | | | | |
|---------------------------|---------------------------|-------------------------------|-------------------------------|----------------------------|----------------------------|----------------------------|----------------------------|-------------------------------|-------------------------------|----------------------------|----------------------------|
| ART. 27428 P ↓ 21 ↔ 11 cm | ART. 27506 P ↓ 21 ↔ 11 cm | ART. 29526 P ↓ 18,5 ↔ 17 cm | ART. 29614 P ↓ 18,5 ↔ 17 cm | ART. 26426 Ø 5 ↓ 21 ↔ 9 cm | ART. 26620 Ø 4 ↓ 13 ↔ 7 cm | ART. 26621 Ø 4 ↓ 13 ↔ 7 cm | ART. 26427 Ø 5 ↓ 21 ↔ 9 cm | ART. 29534 P ↓ 18,5 ↔ 17 cm | ART. 29616 P ↓ 18,5 ↔ 17 cm | ART. 27485 P ↓ 11 ↔ 7 cm | ART. 27593 P ↓ 13 ↔ 8 cm |
| ART. 27429 I ↓ 21 ↔ 11 cm | ART. 27507 I ↓ 21 ↔ 11 cm | ART. 29533 R/C ↓ 18,5 ↔ 17 cm | ART. 29615 R/C ↓ 18,5 ↔ 17 cm | ART. 26109 Ø 5 ↓ 21 ↔ 9 cm | ART. 26184 Ø 4 ↓ 13 ↔ 7 cm | ART. 26297 Ø 4 ↓ 13 ↔ 7 cm | ART. 26110 Ø 5 ↓ 21 ↔ 9 cm | ART. 29535 R/C ↓ 18,5 ↔ 17 cm | ART. 29617 R/C ↓ 18,5 ↔ 17 cm | ART. 27634 P ↓ 13 ↔ 8 cm | ART. 27592 R/C ↓ 13 ↔ 8 cm |
| | ART. 27533 P ↓ 28 ↔ 16 cm | | | | | | | | | ART. 27633 R/C ↓ 13 ↔ 8 cm | |

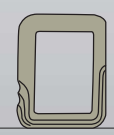

| | | | | | | |
|----------------------------|----------------------------|---------------------|---------------------|-------------------------|----------------------|----------------------|
| ART. 27474 P ↓ 11 ↔ 7 cm | ART. 27589 P ↓ 13 ↔ 8 cm | ART. 20665 9x12 cm | ART. 20668 9x12 cm | ART. 24322 ↓ 20 ↔ 11 cm | ART. 200088 9x12 cm | ART. 200091 9x12 cm |
| ART. 27632 P ↓ 13 ↔ 8 cm | ART. 27588 R/C ↓ 13 ↔ 8 cm | ART. 20666 11x15 cm | ART. 20669 10x15 cm | | ART. 200089 11x15 cm | ART. 200092 10x15 cm |
| ART. 27631 R/C ↓ 13 ↔ 8 cm | | ART. 20667 13x18 cm | ART. 20670 11x15 cm | | ART. 200090 13x18 cm | ART. 200093 11x15 cm |
| | | | ART. 20671 13x18 cm | | | ART. 200094 13x18 cm |

Per ordinazioni aggiungere al codice articolo la sigla corrispondente alla colorazione scelta.
To place orders add to the article code the letter corresponding the selected colouring.

Per ordinazioni aggiungere al codice articolo la sigla corrispondente alla colorazione scelta.
To place orders add to the article code the letter corresponding the selected colouring.

Porcellana bianca con intarsio marmorizzato e inserti in acciaio inox 18/10



ART. 27443 P
↓ 21 ↔ 11 cm

ART. 27514 P
↓ 21 ↔ 11 cm
ART. 27515 I
↓ 21 ↔ 11 cm
ART. 27557 P
↓ 28 ↔ 16 cm
ART. 27556 I
↓ 28 ↔ 16 cm

ART. 29541 P
↓ 18,5 ↔ 17 cm

ART. 29620 P
↓ 18,5 ↔ 17 cm

ART. 29550 R/C
↓ 18,5 ↔ 17 cm

ART. 29621 R/C
↓ 18,5 ↔ 17 cm

ART. 26429 Ø 5
↓ 21 ↔ 9 cm

ART. 26622 Ø 4
↓ 13 ↔ 7 cm

ART. 26112 Ø 5
↓ 21 ↔ 9 cm

ART. 26298 Ø 4
↓ 13 ↔ 7 cm

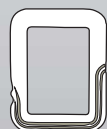

ART. 27486 P
↓ 11 ↔ 7 cm
ART. 27636 P
↓ 13 ↔ 8 cm
ART. 27635 R/C
↓ 13 ↔ 8 cm

ART. 27595 P
↓ 13 ↔ 8 cm
ART. 27594 R/C
↓ 13 ↔ 8 cm

ART. 200164 9x12 cm
ART. 200165 11x15 cm
ART. 200166 13x18 cm

ART. 200167 9x12 cm
ART. 200168 10x15 cm
ART. 200169 11x15 cm
ART. 200170 13x18 cm

ART. 24395
↓ 20 ↔ 11 cm

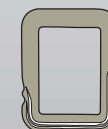

ART. 26623 Ø 4
↓ 13 ↔ 7 cm

ART. 26431 Ø 5
↓ 21 ↔ 9 cm

ART. 26299 Ø 4
↓ 13 ↔ 7 cm

ART. 26113 Ø 5
↓ 21 ↔ 9 cm

ART. 29551 P
↓ 18,5 ↔ 17 cm

ART. 29622 P
↓ 18,5 ↔ 17 cm

ART. 29552 R/C
↓ 18,5 ↔ 17 cm

ART. 29623 R/C
↓ 18,5 ↔ 17 cm

ART. 27445 P
↓ 21 ↔ 11 cm

ART. 27516 P
↓ 21 ↔ 11 cm
ART. 27517 I
↓ 21 ↔ 11 cm
ART. 27559 P
↓ 28 ↔ 16 cm
ART. 27558 I
↓ 28 ↔ 16 cm

ART. 27487 P
↓ 11 ↔ 7 cm
ART. 27597 P
↓ 13 ↔ 8 cm
ART. 27596 R/C
↓ 13 ↔ 8 cm

ART. 27638 P
↓ 13 ↔ 8 cm
ART. 27637 R/C
↓ 13 ↔ 8 cm

ART. 200171 9x12 cm
ART. 200172 11x15 cm
ART. 200173 13x18 cm

ART. 200174 9x12 cm
ART. 200175 10x15 cm
ART. 200176 11x15 cm
ART. 200177 13x18 cm

ART. 24396
↓ 20 ↔ 11 cm

Per ordinazioni aggiungere al codice articolo la sigla corrispondente alla colorazione scelta.
To place orders add to the article code the letter corresponding the selected colouring.

Porcellana Marmorizzata con intarsio bianco e inserti in acciaio inox 18/10



PORCELLANA



ART. 26623 Ø 4
↓ 13 ↔ 7 cm

ART. 26431 Ø 5
↓ 21 ↔ 9 cm

ART. 26299 Ø 4
↓ 13 ↔ 7 cm

ART. 26113 Ø 5
↓ 21 ↔ 9 cm

ART. 29551 P
↓ 18,5 ↔ 17 cm

ART. 29622 P
↓ 18,5 ↔ 17 cm

ART. 29552 R/C
↓ 18,5 ↔ 17 cm

ART. 29623 R/C
↓ 18,5 ↔ 17 cm

ART. 27445 P
↓ 21 ↔ 11 cm

ART. 27516 P
↓ 21 ↔ 11 cm
ART. 27517 I
↓ 21 ↔ 11 cm
ART. 27559 P
↓ 28 ↔ 16 cm
ART. 27558 I
↓ 28 ↔ 16 cm

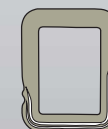

ART. 27487 P
↓ 11 ↔ 7 cm
ART. 27597 P
↓ 13 ↔ 8 cm
ART. 27596 R/C
↓ 13 ↔ 8 cm

ART. 27638 P
↓ 13 ↔ 8 cm
ART. 27637 R/C
↓ 13 ↔ 8 cm

ART. 200171 9x12 cm
ART. 200172 11x15 cm
ART. 200173 13x18 cm

ART. 200174 9x12 cm
ART. 200175 10x15 cm
ART. 200176 11x15 cm
ART. 200177 13x18 cm

ART. 24396
↓ 20 ↔ 11 cm

Per ordinazioni aggiungere al codice articolo la sigla corrispondente alla colorazione scelta.
To place orders add to the article code the letter corresponding the selected colouring.



ART. 27447 P ↓ 21 ↔ 11 cm ART. 27518 P ↓ 21 ↔ 11 cm
 ART. 27448 I ↓ 21 ↔ 11 cm ART. 27519 I ↓ 21 ↔ 11 cm
 ART. 27561 P ↓ 28 ↔ 16 cm
 ART. 27560 I ↓ 28 ↔ 16 cm

ART. 27441 P ↓ 21 ↔ 11 cm ART. 27512 P ↓ 21 ↔ 11 cm
 ART. 27442 I ↓ 21 ↔ 11 cm ART. 27513 I ↓ 21 ↔ 11 cm
 ART. 27563 P ↓ 28 ↔ 16 cm
 ART. 27562 I ↓ 28 ↔ 16 cm



ART. 29553 P ↓ 18,5 ↔ 17 cm ART. 29624 P ↓ 18,5 ↔ 17 cm
 ART. 29554 R/C ↓ 18,5 ↔ 17 cm ART. 29625 R/C ↓ 18,5 ↔ 17 cm

ART. 26437 Ø 5 ↓ 21 ↔ 9 cm ART. 26624 Ø 4 ↓ 13 ↔ 7 cm
 ART. 26114 Ø 5 ↓ 21 ↔ 9 cm ART. 26502 Ø 4 ↓ 13 ↔ 7 cm

ART. 26625 Ø 4 ↓ 13 ↔ 7 cm ART. 26428 Ø 5 ↓ 21 ↔ 9 cm
 ART. 26504 Ø 4 ↓ 13 ↔ 7 cm ART. 26111 Ø 5 ↓ 21 ↔ 9 cm
 ART. 29539 P ↓ 18,5 ↔ 17 cm ART. 29618 P ↓ 18,5 ↔ 17 cm
 ART. 29540 R/C ↓ 18,5 ↔ 17 cm ART. 29619 R/C ↓ 18,5 ↔ 17 cm



ART. 27488 P ↓ 11 ↔ 7 cm ART. 27599 P ↓ 13 ↔ 8 cm
 ART. 27640 P ↓ 13 ↔ 8 cm ART. 27598 R/C ↓ 13 ↔ 8 cm
 ART. 27639 R/C ↓ 13 ↔ 8 cm

ART. 200074 9x12 cm
 ART. 200075 11x15 cm
 ART. 200076 13x18 cm

ART. 200077 9x12 cm
 ART. 200078 10x15 cm
 ART. 200079 11x15 cm
 ART. 200080 13x18 cm

ART. 24375
 ↓ 20 ↔ 11 cm

ART. 27489 P ↓ 11 ↔ 7 cm ART. 27581 P ↓ 13 ↔ 8 cm
 ART. 27642 P ↓ 13 ↔ 8 cm ART. 27580 R/C ↓ 13 ↔ 8 cm
 ART. 27641 R/C ↓ 13 ↔ 8 cm

ART. 200081 9x12 cm
 ART. 200082 11x15 cm
 ART. 200083 13x18 cm

ART. 200084 9x12 cm
 ART. 200085 10x15 cm
 ART. 200086 11x15 cm
 ART. 200087 13x18 cm

ART. 24376
 ↓ 20 ↔ 11 cm

Porcellana Bianca con inserti in acciaio inox 18/10



ART. 27410 P ↓ 20 ↔ 12,5 cm
 ART. 27411 I ↓ 20 ↔ 12,5 cm
 ART. 27262 P ↓ 20 ↔ 12,5 cm
 ART. 27263 I ↓ 20 ↔ 12,5 cm



ART. 29390 P ↓ 18 ↔ 17 cm
 ART. 29399 R/C ↓ 18 ↔ 17 cm
 ART. 29590 P ↓ 18 ↔ 17 cm
 ART. 29591 R/C ↓ 18 ↔ 17 cm



ART. 26415 Ø 5 ↓ 21 ↔ 9,5 cm
 ART. 26162 Ø 5 ↓ 21 ↔ 9,5 cm



ART. 26415 Ø 5 ↓ 21 ↔ 9,5 cm
 ART. 26162 Ø 5 ↓ 21 ↔ 9,5 cm

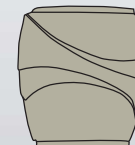

ART. 29390 P ↓ 18 ↔ 17 cm
 ART. 29399 R/C ↓ 18 ↔ 17 cm
 ART. 29590 P ↓ 18 ↔ 17 cm
 ART. 29591 R/C ↓ 18 ↔ 17 cm



ART. 27410 P ↓ 20 ↔ 12,5 cm
 ART. 27411 I ↓ 20 ↔ 12,5 cm
 ART. 27262 P ↓ 20 ↔ 12,5 cm
 ART. 27263 I ↓ 20 ↔ 12,5 cm



ART. 20153 7x9 cm
 ART. 20154 8x10 cm
 ART. 20263 9x12 cm
 ART. 20264 11x15 cm
 ART. 20265 13x18 cm



ART. 20323 7x9 cm
 ART. 20324 8x10 cm
 ART. 20345 9x12 cm
 ART. 20346 10x15 cm
 ART. 20347 11x15 cm
 ART. 20348 13x18 cm



ART. 24195 ↓ 10 ↔ 6 cm
 ART. 24196 ↓ 15 ↔ 9 cm
 ART. 24197 ↓ 20 ↔ 11 cm
 ART. 24198 ↓ 30 ↔ 14 cm
 ART. 24199 ↓ 40 ↔ 15 cm



ART. 24195 ↓ 10 ↔ 6 cm
 ART. 24196 ↓ 15 ↔ 9 cm
 ART. 24197 ↓ 20 ↔ 11 cm
 ART. 24198 ↓ 30 ↔ 14 cm
 ART. 24199 ↓ 40 ↔ 15 cm

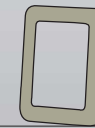

ART. 20323 7x9 cm
 ART. 20324 8x10 cm
 ART. 20345 9x12 cm
 ART. 20346 10x15 cm
 ART. 20347 11x15 cm
 ART. 20348 13x18 cm



ART. 20153 7x9 cm
 ART. 20154 8x10 cm
 ART. 20263 9x12 cm
 ART. 20264 11x15 cm
 ART. 20265 13x18 cm

Porcellana marmorizzata con inserti in acciaio inox 18/10

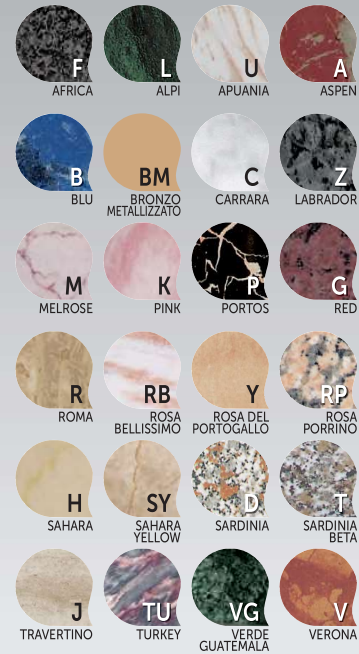

PORCELLANA

Per ordinazioni aggiungere al codice articolo la sigla corrispondente alla colorazione scelta.
 To place orders add to the article code the letter corresponding the selected colouring.

Porcellana Bianca + fasce marmorizzate con inserti in acciaio inox 18/10



ART. 27414 P
↓ 20 ↔ 12,5 cm.

ART. 27266 P T
↓ 20 ↔ 12,5 cm.

ART. 29487 P
↓ 18 ↔ 17 cm.

ART. 29588 P T
↓ 18 ↔ 17 cm.

ART. 26417 Ø 5 P
↓ 21 ↔ 9,5 cm.

ART. 27415 I
↓ 20 ↔ 12,5 cm.

ART. 27267 I
↓ 20 ↔ 12,5 cm.

ART. 29488 R/C
↓ 18 ↔ 17 cm.

ART. 29589 R/C
↓ 18 ↔ 17 cm.

ART. 26172 Ø 5 T
↓ 21 ↔ 9,5 cm.

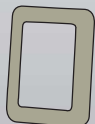

ART. 20153 7x9 cm
ART. 20154 8x10 cm
ART. 20263 9x12 cm
ART. 20264 11x15 cm
ART. 20265 13x18 cm

ART. 20323 7x9 cm
ART. 20324 8x10 cm
ART. 20345 9x12 cm
ART. 20346 10x15 cm
ART. 20347 11x15 cm
ART. 20348 13x18 cm

ART. 24195 ↓ 10 ↔ 6 cm
ART. 24196 ↓ 15 ↔ 9 cm
ART. 24197 ↓ 20 ↔ 11 cm
ART. 24198 ↓ 30 ↔ 14 cm
ART. 24199 ↓ 40 ↔ 15 cm

Per ordinazioni aggiungere al codice articolo la sigla corrispondente alla colorazione scelta.
To place orders add to the article code the letter corresponding the selected colouring.

Porcellana Marmorizzata + fasce bianche con inserti in acciaio inox 18/10



PORCELLANA

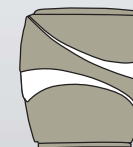

ART. 26416 Ø 5 P
↓ 21 ↔ 9,5 cm

ART. 29489 P
↓ 18 ↔ 17 cm

ART. 29586 P T
↓ 18 ↔ 17 cm

ART. 27412 P
↓ 20 ↔ 12,5 cm

ART. 27264 P T
↓ 20 ↔ 12,5 cm

ART. 26163 Ø 5 T
↓ 21 ↔ 9,5 cm

ART. 29490 R/C
↓ 18 ↔ 17 cm

ART. 29587 R/C
↓ 18 ↔ 17 cm

ART. 27413 I
↓ 20 ↔ 12,5 cm

ART. 27265 I
↓ 20 ↔ 12,5 cm

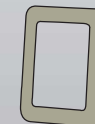

ART. 24195 ↓ 10 ↔ 6 cm
ART. 24196 ↓ 15 ↔ 9 cm
ART. 24197 ↓ 20 ↔ 11 cm
ART. 24198 ↓ 30 ↔ 14 cm
ART. 24199 ↓ 40 ↔ 15 cm

ART. 20323 7x9 cm
ART. 20324 8x10 cm
ART. 20345 9x12 cm
ART. 20346 10x15 cm
ART. 20347 11x15 cm
ART. 20348 13x18 cm

ART. 20153 7x9 cm
ART. 20154 8x10 cm
ART. 20263 9x12 cm
ART. 20264 11x15 cm
ART. 20265 13x18 cm

Per ordinazioni aggiungere al codice articolo la sigla corrispondente alla colorazione scelta.
To place orders add to the article code the letter corresponding the selected colouring.

Porcellana bianca con decoro color platino



Porcellana bianca
con decoro color oro



Porcellana ivory
con decoro color oro



ART. 27668 P ↓ 20 ↔ 12,5 cm
ART. 27669 I ↓ 20 ↔ 12,5 cm
ART. 27716 P ↓ 20 ↔ 12,5 cm
ART. 27717 I ↓ 20 ↔ 12,5 cm



P ART. 27670 P ↓ 20 ↔ 12,5 cm
ART. 27671 R ↓ 20 ↔ 12,5 cm
T ART. 27718 P ↓ 20 ↔ 12,5 cm
ART. 27719 R ↓ 20 ↔ 12,5 cm



P ART. 27672 P ↓ 20 ↔ 12,5 cm
ART. 27673 R ↓ 20 ↔ 12,5 cm
T ART. 27720 P ↓ 20 ↔ 12,5 cm
ART. 27721 R ↓ 20 ↔ 12,5 cm



ART. 29877 P ↓ 18 ↔ 17 cm
ART. 29878 R/C ↓ 18 ↔ 17 cm
ART. 29735 P ↓ 18 ↔ 17 cm
ART. 29736 R/C ↓ 18 ↔ 17 cm



ART. 26446 Ø 5 ↓ 21 ↔ 9,5 cm
ART. 26059 Ø 5 ↓ 21 ↔ 9,5 cm



P ART. 26447 Ø 5 ↓ 21 ↔ 9,5 cm
T ART. 26054 Ø 5 ↓ 21 ↔ 9,5 cm



P ART. 26448 Ø 5 ↓ 21 ↔ 9,5 cm
T ART. 26055 Ø 5 ↓ 21 ↔ 9,5 cm



ART. 200065 7x9 cm
ART. 200066 8x10 cm
ART. 200067 9x12 cm
ART. 200068 11x15 cm
ART. 200069 13x18 cm



ART. 200070 9x12 cm
ART. 200071 10x15 cm
ART. 200072 11x15 cm
ART. 200073 13x18 cm



ART. 24369 ↓ 10 ↔ 6 cm
ART. 24370 ↓ 15 ↔ 9 cm
ART. 24371 ↓ 20 ↔ 11 cm
ART. 24372 ↓ 30 ↔ 14 cm
ART. 24373 ↓ 40 ↔ 15 cm



ART. 200107 7x9 cm
ART. 200108 8x10 cm
ART. 200109 9x12 cm
ART. 200110 11x15 cm
ART. 200111 13x18 cm



ART. 200116 7x9 cm
ART. 200117 8x10 cm
ART. 200118 9x12 cm
ART. 200119 11x15 cm
ART. 200120 13x18 cm



ART. 200112 9x12 cm
ART. 200113 10x15 cm
ART. 200114 11x15 cm
ART. 200115 13x18 cm



ART. 200121 9x12 cm
ART. 200122 10x15 cm
ART. 200123 11x15 cm
ART. 200124 13x18 cm



ART. 24378 ↓ 10 ↔ 6 cm
ART. 24379 ↓ 15 ↔ 9 cm
ART. 24380 ↓ 20 ↔ 11 cm
ART. 24381 ↓ 30 ↔ 14 cm
ART. 24382 ↓ 40 ↔ 15 cm



ART. 24383 ↓ 10 ↔ 6 cm
ART. 24384 ↓ 15 ↔ 9 cm
ART. 24385 ↓ 20 ↔ 11 cm
ART. 24386 ↓ 30 ↔ 14 cm
ART. 24387 ↓ 40 ↔ 15 cm

Porcellana Bianca con inserti in acciaio inox 18/10

PORCELLANA



ART. 27158 P **T**
↓ 29 ↔ 16 cm



ART. 27333 P **P**
↓ 21 ↔ 11,5 cm



ART. 27174 P **T**
↓ 21 ↔ 11,5 cm



ART. 27345 P **P**
↓ 11,5 ↔ 6 cm



ART. 27168 R/C
↓ 29 ↔ 16 cm



ART. 27341 R **P**
↓ 21 ↔ 11,5 cm



ART. 27178 R **T**
↓ 21 ↔ 11,5 cm



ART. 27342 R/C
↓ 14 ↔ 8 cm

ART. 27180 R/C
↓ 14 ↔ 9 cm



ART. 26151 Ø 6 **T**
↓ 27,5 ↔ 12 cm



ART. 26309 Ø 5 **P**
↓ 19 ↔ 8,5 cm

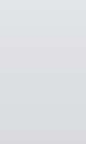

ART. 26178 Ø 5 **T**
↓ 19 ↔ 8,5 cm



ART. 26343 Ø 4 **P**
↓ 15 ↔ 7 cm

ART. 26345 Ø 4 **P**
↓ 13 ↔ 6 cm



ART. 26179 Ø 4 **T**
↓ 15 ↔ 7 cm



ART. 29786 **T**
senza interno
↓ 17,5 ↔ 18,5 cm



ART. 29478 P **P**
↓ 19,5 ↔ 16 cm

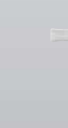

ART. 29201 P **T**
↓ 19,5 ↔ 16 cm

ART. 26968 P **P**
↓ 19 ↔ 12 cm

ART. 26868 **T**
↓ 19 ↔ 12 cm

ART. 29785 **T**
senza interno
↓ 11 ↔ 19 cm

ART. 29479 R/C
↓ 19,5 ↔ 16 cm

ART. 29202 R/C
↓ 19,5 ↔ 16 cm

ART. 26869 **T**
↓ 21 ↔ 15 cm



ART. 20153 7x9 cm
ART. 20154 8x10 cm
ART. 20263 9x12 cm
ART. 20264 11x15 cm
ART. 20265 13x18 cm



ART. 20323 7x9 cm
ART. 20324 8x10 cm
ART. 20345 9x12 cm
ART. 20346 10x15 cm
ART. 20347 11x15 cm
ART. 20348 13x18 cm



ART. 20898 9x12 cm
ART. 20899 11x15 cm
ART. 20900 13x18 cm



ART. 20901 9x12 cm
ART. 20902 10x15 cm
ART. 20909 11x15 cm
ART. 20910 13x18 cm



ART. 24195
↓ 10 ↔ 6 cm
ART. 24196
↓ 15 ↔ 9 cm
ART. 24197
↓ 20 ↔ 11 cm
ART. 24198
↓ 30 ↔ 14 cm
ART. 24199
↓ 40 ↔ 15 cm

Porcellana marmorizzata con inserti in acciaio inox 18/10



Per ordinazioni aggiungere al codice articolo la sigla corrispondente alla colorazione scelta.
To place orders add to the article code the letter corresponding the selected colouring.

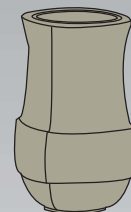

ART. 27158 P
↓ 29 ↔ 16 cm

ART. 27168 R/C
↓ 29 ↔ 16 cm

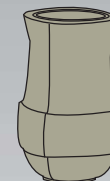

ART. 27333 P
↓ 21 ↔ 11,5 cm

ART. 27341 R
↓ 21 ↔ 11,5 cm

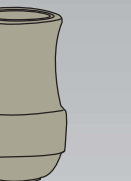

ART. 27174 P
↓ 21 ↔ 11,5 cm

ART. 27178 R
↓ 21 ↔ 11,5 cm



ART. 27343 P
↓ 14 ↔ 8 cm

ART. 27342 R/C
↓ 14 ↔ 8 cm



ART. 27179 P
↓ 14 ↔ 8 cm

ART. 27180 R
↓ 14 ↔ 8 cm

PORCELLANA



ART. 26151 Ø 6
↓ 27,5 ↔ 12 cm



ART. 26309 Ø 5
↓ 19 ↔ 8,5 cm



ART. 26178 Ø 5
↓ 19 ↔ 8,5 cm



ART. 26343 Ø 4
↓ 15 ↔ 7 cm



ART. 26345 Ø 4
↓ 13 ↔ 6 cm

ART. 26179 Ø 4
↓ 15 ↔ 7 cm



ART. 29786
senza interno
↓ 17,5 ↔ 18,5 cm

ART. 29785
senza interno
↓ 11 ↔ 19 cm



ART. 29478 P
↓ 19,5 ↔ 16 cm

ART. 29479 R/C
↓ 19,5 ↔ 16 cm

ART. 29201 P
↓ 19 ↔ 16 cm

ART. 29202 R/C
↓ 19 ↔ 16 cm



ART. 26968 P
↓ 19 ↔ 12 cm

ART. 26868 T
↓ 19 ↔ 12 cm

ART. 26869
↓ 21 ↔ 15 cm



ART. 20153 7x9 cm
ART. 20154 8x10 cm
ART. 20263 9x12 cm
ART. 20264 11x15 cm
ART. 20265 13x18 cm



ART. 20323 7x9 cm
ART. 20324 8x10 cm
ART. 20345 9x12 cm
ART. 20346 10x15 cm
ART. 20347 11x15 cm
ART. 20348 13x18 cm

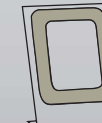

ART. 20901 9x12 cm
ART. 20902 10x15 cm
ART. 20909 11x15 cm
ART. 20910 13x18 cm



ART. 20898 9x12 cm
ART. 20899 11x15 cm
ART. 20900 13x18 cm



ART. 24195
↓ 10 ↔ 6 cm
ART. 24196
↓ 15 ↔ 9 cm
ART. 24197
↓ 20 ↔ 11 cm
ART. 24198
↓ 30 ↔ 14 cm
ART. 24199
↓ 40 ↔ 15 cm

Porcellana Bianca con inserti in acciaio inox 18/10



- ART. 27223 P \updownarrow 21 cm \leftrightarrow 12 cm
- ART. 27222 I \updownarrow 21 cm \leftrightarrow 12 cm
- ART. 27088 P \updownarrow 21 cm \leftrightarrow 16 cm
- ART. 27087 I \updownarrow 21 cm \leftrightarrow 16 cm
- ART. 27090 P \updownarrow 28 cm \leftrightarrow 16 cm
- ART. 27089 I \updownarrow 28 cm \leftrightarrow 16 cm



- ART. 29224 P \updownarrow 18 cm \leftrightarrow 16 cm
- ART. 29223 R/C \updownarrow 18 cm \leftrightarrow 16 cm

- ART. 29028 P \updownarrow 18 cm \leftrightarrow 16 cm
- ART. 29026 R/C \updownarrow 18 cm \leftrightarrow 16 cm



- ART. 26223 \emptyset 5 P \updownarrow 20,5 cm \leftrightarrow 12 cm
- ART. 26088 \emptyset 5 T \updownarrow 20,5 cm \leftrightarrow 12 cm

- ART. 26090 \emptyset 6 \updownarrow 26 cm \leftrightarrow 12 cm



- ART. 26954 P \updownarrow 17 \leftrightarrow 12 cm
- ART. 26854 T \updownarrow 17 \leftrightarrow 12 cm
- ART. 26855 \updownarrow 23 \leftrightarrow 15 cm



- ART. 20323 7x9 cm
- ART. 20324 8x10 cm
- ART. 20345 9x12 cm
- ART. 20346 10x15 cm
- ART. 20347 11x15 cm
- ART. 20348 13x18 cm



- ART. 20153 7x9 cm
- ART. 20154 8x10 cm
- ART. 20263 9x12 cm
- ART. 20264 11x15 cm
- ART. 20265 13x18 cm



- ART. 24195 \updownarrow 10 \leftrightarrow 6 cm
- ART. 24196 \updownarrow 15 \leftrightarrow 9 cm
- ART. 24197 \updownarrow 20 \leftrightarrow 11 cm
- ART. 24198 \updownarrow 30 \leftrightarrow 14 cm
- ART. 24199 \updownarrow 40 \leftrightarrow 15 cm

Porcellana marmorizzata con inserti in acciaio inox 18/10



PORCELLANA



- ART. 26223 \emptyset 5 P \updownarrow 20,5 cm \leftrightarrow 12 cm
- ART. 26088 \emptyset 5 T \updownarrow 20,5 cm \leftrightarrow 12 cm
- ART. 26090 \emptyset 6 \updownarrow 26 cm \leftrightarrow 12 cm



- ART. 29224 P \updownarrow 18 cm \leftrightarrow 16 cm
- ART. 29223 R/C \updownarrow 18 cm \leftrightarrow 16 cm
- ART. 29028 P \updownarrow 18 cm \leftrightarrow 16 cm
- ART. 29026 R/C \updownarrow 18 cm \leftrightarrow 16 cm



- ART. 27223 P \updownarrow 21 cm \leftrightarrow 12 cm
- ART. 27222 I \updownarrow 21 cm \leftrightarrow 12 cm
- ART. 27088 P \updownarrow 21 cm \leftrightarrow 16 cm
- ART. 27087 I \updownarrow 21 cm \leftrightarrow 16 cm
- ART. 27090 P \updownarrow 28 cm \leftrightarrow 16 cm
- ART. 27089 I \updownarrow 28 cm \leftrightarrow 16 cm



- ART. 24195 \updownarrow 10 \leftrightarrow 6 cm
- ART. 24196 \updownarrow 15 \leftrightarrow 9 cm
- ART. 24197 \updownarrow 20 \leftrightarrow 11 cm
- ART. 24198 \updownarrow 30 \leftrightarrow 14 cm
- ART. 24199 \updownarrow 40 \leftrightarrow 15 cm



- ART. 20323 7x9 cm
- ART. 20324 8x10 cm
- ART. 20345 9x12 cm
- ART. 20346 10x15 cm
- ART. 20347 11x15 cm
- ART. 20348 13x18 cm



- ART. 20153 7x9 cm
- ART. 20154 8x10 cm
- ART. 20263 9x12 cm
- ART. 20264 11x15 cm
- ART. 20265 13x18 cm



- ART. 26954 P \updownarrow 17 \leftrightarrow 12 cm
- ART. 26854 T \updownarrow 17 \leftrightarrow 12 cm
- ART. 26855 \updownarrow 23 \leftrightarrow 15 cm

Per ordinazioni aggiungere al codice articolo la sigla corrispondente alla colorazione scelta.
To place orders add to the article code the letter corresponding to the selected colouring.

Porcellana Bianca con inserti in acciaio inox 18/10



ART. 21522 P T
↓ 29 ↔ 16 cm.



ART. 21260 P P
↓ 21 ↔ 13 cm.



ART. 21520 P T
↓ 21 ↔ 13 cm.



ART. 21258 P P
↓ 14 ↔ 8 cm.



ART. 21518 P T
↓ 14 ↔ 8 cm.



ART. 29363 P P
↓ 19 ↔ 17 cm.



mezza vaschetta P
ART. 29377 P
↓ 19 ↔ 20 cm.



mezza lampada P
ART. 22377 Ø 5
↓ 21 ↔ 10 cm.



ART. 22845 T
↓ 22 ↔ 17 cm.



ART. 22938 P
↓ 17,5 ↔ 14 cm.

ART. 22838 T
↓ 17,5 ↔ 14 cm.



ART. 22521 Ø 6 T
↓ 28 ↔ 13 cm.



ART. 22269 Ø 5 P
↓ 20 ↔ 10 cm.



ART. 22520 Ø 5 T
↓ 20 ↔ 10 cm.



ART. 22258 Ø 4 P
↓ 14 ↔ 8 cm.

ART. 22518 Ø 4 T
↓ 14 ↔ 8 cm.



ART. 20153 7x9 cm
ART. 20154 8x10 cm
ART. 20263 9x12 cm
ART. 20264 11x15 cm
ART. 20265 13x18 cm



ART. 20323 7x9 cm
ART. 20324 8x10 cm
ART. 20345 9x12 cm
ART. 20346 10x15 cm
ART. 20347 11x15 cm
ART. 20348 13x18 cm



ART. 20898 9x12 cm
ART. 20899 11x15 cm
ART. 20900 13x18 cm



ART. 20901 9x12 cm
ART. 20902 10x15 cm
ART. 20909 11x15 cm
ART. 20910 13x18 cm



ART. 24195
↓ 10 ↔ 6 cm
ART. 24196
↓ 15 ↔ 9 cm
ART. 24197
↓ 20 ↔ 11 cm
ART. 24198
↓ 30 ↔ 14 cm
ART. 24199
↓ 40 ↔ 15 cm

PORCELLANA

Porcellana Bianca con inserti in acciaio inox 18/10



Per ordinazioni aggiungere al codice articolo la sigla corrispondente alla colorazione scelta.
To place orders add to the article code the letter corresponding the selected colouring.

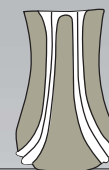

ART. 21258 P
↓ 14 ↔ 8 cm.

ART. 21259 R/C
↓ 14 ↔ 8 cm.

ART. 21260 P
↓ 21 ↔ 13 cm.

ART. 21261 R/C
↓ 21 ↔ 13 cm.

ART. 21518 P T
↓ 14 ↔ 8 cm.

ART. 21519 R/C
↓ 14 ↔ 8 cm.

ART. 21520 P
↓ 21 ↔ 13 cm.

ART. 21521 R
↓ 21 ↔ 13 cm.

ART. 21522 P
↓ 29 ↔ 16 cm.

ART. 21523 R/C
↓ 29 ↔ 16 cm.

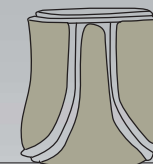

ART. 29363 P
↓ 19 ↔ 20 cm.

ART. 29362 R/C
↓ 19 ↔ 20 cm.

ART. 29061 P T
↓ 19 ↔ 20 cm.

ART. 29062 R/C
↓ 19 ↔ 20 cm.

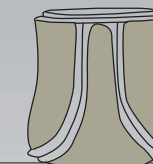

mezza vaschetta P
ART. 29377 P
↓ 19 ↔ 20 cm.



ART. 22258 Ø 4 P
↓ 14 ↔ 18 cm.

ART. 22269 Ø 5
↓ 20 ↔ 10 cm.

ART. 22518 Ø 4 T
↓ 14 ↔ 18 cm.

ART. 22520 Ø 5
↓ 20 ↔ 10 cm.

ART. 22521 Ø 6
↓ 28 ↔ 13 cm.



mezza lampada P
ART. 22377 Ø 5
↓ 21 ↔ 10 cm.



ART. 22938 4 gg. P
↓ 17,5 ↔ 14 cm.

ART. 22845 6 gg. T
↓ 22 ↔ 17 cm.



ART. 20153 7x9 cm
ART. 20154 8x10 cm
ART. 20263 9x12 cm
ART. 20264 11x15 cm
ART. 20265 13x18 cm



ART. 20323 7x9 cm
ART. 20324 8x10 cm
ART. 20345 9x12 cm
ART. 20346 10x15 cm
ART. 20347 11x15 cm
ART. 20348 13x18 cm



ART. 20901 9x12 cm
ART. 20902 10x15 cm
ART. 20909 11x15 cm
ART. 20910 13x18 cm

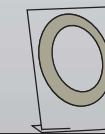

ART. 20898 9x12 cm
ART. 20899 11x15 cm
ART. 20900 13x18 cm



ART. 24195
↓ 10 ↔ 6 cm
ART. 24196
↓ 15 ↔ 9 cm
ART. 24197
↓ 20 ↔ 11 cm
ART. 24198
↓ 30 ↔ 14 cm
ART. 24199
↓ 40 ↔ 15 cm

Porcellana bianca con inserti in acciaio inox 18/10



ART. 27129 P T
↓ 28 ↔ 17 cm



ART. 27435 P P ART. 27135 P T
↓ 20 ↔ 12 cm ↓ 20 ↔ 12 cm



ART. 29448 P P
↓ 19 ↔ 16 cm



ART. 27437 P P
↓ 12 ↔ 7,5 cm



ART. 27438 P P
↓ 11 ↔ 6,5 cm

ART. 27128 I
↓ 28 ↔ 17 cm

ART. 27434 I
↓ 20 ↔ 12 cm

ART. 27134 I
↓ 20 ↔ 12 cm

ART. 29447 R/C
↓ 19 ↔ 16 cm

ART. 27436 R/C
↓ 12 ↔ 7,5 cm

ART. 29135 P T
↓ 19 ↔ 16 cm

ART. 27138 P T
↓ 12 ↔ 7,5 cm

ART. 29134 R/C
↓ 19 ↔ 16 cm

ART. 27137 R/C
↓ 12 ↔ 7,5 cm



ART. 26128 Ø 6 T
↓ 27 ↔ 12 cm



ART. 26434 Ø 5 P
↓ 21 ↔ 10 cm



ART. 26436 Ø 4 P
↓ 13 ↔ 7 cm



ART. 26917 P
↓ 17 ↔ 11 cm

ART. 26817 T
↓ 17 ↔ 11 cm

ART. 26134 Ø 5 T
↓ 21 ↔ 10 cm

ART. 26137 Ø 4 T
↓ 13 ↔ 7 cm

ART. 26818
↓ 23 ↔ 15 cm



ART. 20153 7x9 cm
ART. 20154 8x10 cm
ART. 20263 9x12 cm
ART. 20264 11x15 cm
ART. 20265 13x18 cm



ART. 20323 7x9 cm
ART. 20324 8x10 cm
ART. 20345 9x12 cm
ART. 20346 10x15 cm
ART. 20347 11x15 cm
ART. 20348 13x18 cm



ART. 24195 ↓ 10 ↔ 6 cm
ART. 24196 ↓ 15 ↔ 9 cm
ART. 24197 ↓ 20 ↔ 11 cm
ART. 24198 ↓ 30 ↔ 14 cm
ART. 24199 ↓ 40 ↔ 15 cm

PORCELLANA

Porcellana marmorizzata con inserti in acciaio inox 18/10

Porcellana marmorizzata con inserti in acciaio inox 18/10



- ART. 27435 P P ART. 27138 P T
 ↓ 20 ↔ 12 cm ↓ 12 ↔ 7,5 cm
- ART. 27434 I ART. 27137 R/C
 ↓ 20 ↔ 12 cm ↓ 12 ↔ 7,5 cm
- ART. 27437 P ART. 27135 P
 ↓ 12 ↔ 7,5 cm ↓ 20 ↔ 12 cm
- ART. 27436 R/C ART. 27134 I
 ↓ 12 ↔ 7,5 cm ↓ 20 ↔ 12 cm
- ART. 27129 P ART. 27128 I
 ↓ 28 ↔ 17 cm ↓ 28 ↔ 17 cm

- ART. 27654 P P ART. 27814 P T
 ↓ 20 ↔ 12 cm ↓ 12 ↔ 7,5 cm
- ART. 27653 I ART. 27813 R/C
 ↓ 20 ↔ 12 cm ↓ 12 ↔ 7,5 cm
- ART. 27656 P ART. 27812 P
 ↓ 12 ↔ 7,5 cm ↓ 20 ↔ 12 cm
- ART. 27655 R/C ART. 27811 I
 ↓ 12 ↔ 7,5 cm ↓ 20 ↔ 12 cm
- ART. 27810 P ART. 27809 I
 ↓ 28 ↔ 17 cm ↓ 28 ↔ 17 cm

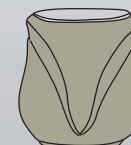
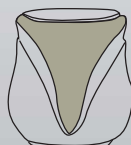

- ART. 26917 4 gg. P ↓ 17 ↔ 11 cm
- ART. 26817 4 gg. T ↓ 17 ↔ 11 cm
- ART. 29448 P P ↓ 19 ↔ 16 cm
- ART. 29135 P T ↓ 19 ↔ 16 cm
- ART. 26434 Ø 5 P ↓ 21 ↔ 10 cm
- ART. 26128 Ø 6 T ↓ 27 ↔ 12 cm
- ART. 26436 Ø 4 ↓ 13 ↔ 7 cm
- ART. 26134 Ø 5 ↓ 21 ↔ 10 cm
- ART. 26137 Ø 4 ↓ 13 ↔ 7 cm
- ART. 26982 4 gg. P ↓ 17 ↔ 11 cm
- ART. 26882 4 gg. T ↓ 17 ↔ 11 cm
- ART. 29500 P P ↓ 19 ↔ 16 cm
- ART. 29278 P T ↓ 19 ↔ 16 cm
- ART. 26453 Ø 5 P ↓ 21 ↔ 10 cm
- ART. 26226 Ø 6 T ↓ 27 ↔ 12 cm
- ART. 26455 Ø 4 ↓ 13 ↔ 7 cm
- ART. 26225 Ø 5 ↓ 21 ↔ 10 cm
- ART. 26224 Ø 4 ↓ 13 ↔ 7 cm

Per ordinazioni aggiungere al codice articolo la sigla corrispondente alla colorazione scelta.
 To place orders add to the article code the letter corresponding the selected colouring.

Per ordinazioni aggiungere al codice articolo la sigla corrispondente alla colorazione scelta.
 To place orders add to the article code the letter corresponding the selected colouring.

Porcellana bianca con inserti in acciaio inox 18/10

PORCELLANA



ART. 27046 R **T**
 ↓ 28 ↔ 18 cm



ART. 27347 R **P**
 ↓ 20 ↔ 13,5 cm



ART. 29560 R/C **P**
 ↓ 18 ↔ 18 cm

ART. 27047 R **T**
 ↓ 20 ↔ 13,5 cm

ART. 29060 R/C **T**
 ↓ 18 ↔ 18 cm



ART. 26046 Ø 6 **T**
 ↓ 27 ↔ 12 cm



ART. 26347 Ø 5 **P**
 ↓ 20 ↔ 9 cm



mezza lampada **P**
 ART. 22426 Ø 5
 ↓ 20 ↔ 9 cm

ART. 26047 Ø 5 **T**
 ↓ 20 ↔ 9 cm



mezza vaschetta **P**
 ART. 29333 P
 ↓ 16 ↔ 30 cm



mezza vaschetta **P**
 ART. 29426 P
 ↓ 18 ↔ 18 cm



ART. 26917 **P**
 ↓ 17 ↔ 11 cm

ART. 26817 **T**
 ↓ 17 ↔ 11 cm

ART. 26818
 ↓ 23 ↔ 15 cm



ART. 20153 7x9 cm
 ART. 20154 8x10 cm
 ART. 20263 9x12 cm
 ART. 20264 11x15 cm
 ART. 20265 13x18 cm



ART. 20323 7x9 cm
 ART. 20324 8x10 cm
 ART. 20345 9x12 cm
 ART. 20346 10x15 cm
 ART. 20347 11x15 cm
 ART. 20348 13x18 cm



ART. 20898 9x12 cm
 ART. 20899 11x15 cm
 ART. 20900 13x18 cm



ART. 20901 9x12 cm
 ART. 20902 10x15 cm
 ART. 20909 11x15 cm
 ART. 20910 13x18 cm



ART. 24195
 ↓ 10 ↔ 6 cm
 ART. 24196
 ↓ 15 ↔ 9 cm
 ART. 24197
 ↓ 20 ↔ 11 cm
 ART. 24198
 ↓ 30 ↔ 14 cm
 ART. 24199
 ↓ 40 ↔ 15 cm

Porcellana marmorizzata con inserti in acciaio inox 18/10

Porcellana marmorizzata con inserti in acciaio inox 18/10



PORCELLANA

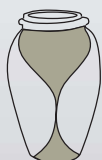

ART. 27347 R **P** ↓ 20 ↔ 13,5 cm
 ART. 27046 R **T** ↓ 28 ↔ 13,5 cm
 ART. 27047 R ↓ 20 ↔ 18 cm

ART. 29560 R/C **P** ↓ 18 ↔ 18 cm
 ART. 29060 R/C **T** ↓ 18 ↔ 18 cm

ART. 26917 4 gg. **P** ↓ 17 ↔ 11 cm
 ART. 26817 6 gg. **T** ↓ 17 ↔ 11 cm
 ART. 26818 6 gg. ↓ 23 ↔ 15 cm

ART. 26982 4 gg. **P** ↓ 17 ↔ 11 cm
 ART. 26882 4 gg. **T** ↓ 17 ↔ 11 cm
 ART. 26883 6 gg. ↓ 23 ↔ 15 cm

ART. 29713 R/C **P** ↓ 18 ↔ 18 cm
 ART. 29649 R/C **T** ↓ 18 ↔ 18 cm
 ART. 27657 R **P** ↓ 20 ↔ 13,5 cm
 ART. 27815 R **T** ↓ 28 ↔ 13,5 cm
 ART. 27816 R ↓ 20 ↔ 13,5 cm



mezza vaschetta **P** ART. 29426 **P** ↓ 18 ↔ 18 cm

mezza lampada **P** ART. 22426 **P** ↓ 20 ↔ 9 cm

ART. 26347 Ø 5 **P** ↓ 20 ↔ 9 cm
 ART. 26046 Ø 6 **T** ↓ 27 ↔ 12 cm
 ART. 26047 Ø 5 ↓ 20 ↔ 9 cm

ART. 26632 Ø 5 **P** ↓ 20 ↔ 9 cm
 ART. 26231 Ø 6 **T** ↓ 27 ↔ 12 cm
 ART. 26232 Ø 5 ↓ 20 ↔ 9 cm

mezza lampada **P** ART. 26633 **P** ↓ 20 ↔ 9 cm

mezza vaschetta **P** ART. 29712 **P** ↓ 18 ↔ 18 cm

Per ordinazioni aggiungere al codice articolo la sigla corrispondente alla colorazione scelta.
 To place orders add to the article code the letter corresponding the selected colouring.

Per ordinazioni aggiungere al codice articolo la sigla corrispondente alla colorazione scelta.
 To place orders add to the article code the letter corresponding the selected colouring.



ART. 27050 R **T**
 ↓ 28 ↔ 18 cm



ART. 27351 R **P**
 ↓ 20 ↔ 13,5 cm



ART. 27051 R **T**
 ↓ 20 ↔ 13,5 cm



ART. 29563 R/C **P**
 ↓ 18 ↔ 18 cm



ART. 29063 R/C **T**
 ↓ 18 ↔ 18 cm



ART. 26050 Ø 6 **T**
 ↓ 27 ↔ 12 cm



ART. 26351 Ø 5 **P**
 ↓ 20 ↔ 9 cm



ART. 26051 Ø 5 **T**
 ↓ 20 ↔ 9 cm



ART. 26919 **P**
 ↓ 17 ↔ 11 cm

ART. 26819 **T**
 ↓ 17 ↔ 11 cm

ART. 26820
 ↓ 23 ↔ 15 cm

ART. 26821
 ↓ 30,5 ↔ 14 cm



mezza lampada **P**
 ART. 22443
 ↓ 20 ↔ 9 cm



mezza vaschetta **P**
 ART. 29443 P
 ↓ 18 ↔ 18 cm



ART. 20423 7x9 cm
 ART. 20424 8x10 cm
 ART. 20425 9x12 cm
 ART. 20426 11x15 cm
 ART. 20427 13x18 cm



ART. 20433 7x9 cm
 ART. 20434 8x10 cm
 ART. 20435 9x12 cm
 ART. 20436 10x15 cm
 ART. 20437 11x15 cm
 ART. 20438 13x18 cm



ART. 20516 9x12 cm
 ART. 20517 11x15 cm
 ART. 20518 13x18 cm



ART. 20603 9x12 cm
 ART. 20604 10x15 cm
 ART. 20605 11x15 cm
 ART. 20606 13x18 cm



ART. 24290 ↓ 10 ↔ 6 cm
 ART. 24291 ↓ 15 ↔ 9 cm
 ART. 24292 ↓ 20 ↔ 11 cm
 ART. 24293 ↓ 30 ↔ 14 cm
 ART. 24294 ↓ 40 ↔ 15 cm

Porcellana bianca con inserti in acciaio inox 18/10

PORCELLANA



ART. 21422 P T
↓ 28 ↔ 16,5 cm

ART. 21423 I
↓ 28 ↔ 16,5 cm



ART. 21242 P P
↓ 20 ↔ 13,5 cm

ART. 21241 I
↓ 20 ↔ 13,5 cm

ART. 21418 P T
↓ 20 ↔ 13,5 cm

ART. 21419 I
↓ 20 ↔ 13,5 cm



ART. 21243 P P
↓ 15 ↔ 9 cm

ART. 21246 R
↓ 15 ↔ 9 cm

ART. 21462 P
↓ 12 ↔ 5,5 cm

ART. 21417 P T
↓ 15 ↔ 9 cm

ART. 21414 R
↓ 15 ↔ 9 cm



ART. 29207 P P
↓ 19 ↔ 18 cm

ART. 29423 P T
↓ 19 ↔ 18 cm

ART. 29206 R/C
↓ 19 ↔ 18 cm

ART. 29422 R/C
↓ 19 ↔ 18 cm



ART. 22421 Ø 6 T
↓ 26 ↔ 13 cm



ART. 22242 Ø 5 P
↓ 20 ↔ 10 cm

ART. 22419 Ø 5 T
↓ 20 ↔ 10 cm



ART. 22243 Ø 4 P
↓ 14 ↔ 8 cm

ART. 22418 Ø 4 T
↓ 14 ↔ 8 cm



ART. 22951 P
↓ 17 ↔ 11 cm

ART. 22852 T
↓ 17 ↔ 11 cm

ART. 22853
↓ 23 ↔ 15 cm



mezza vaschetta P
ART. 29311 P
↓ 17 ↔ 28 cm



ART. 29525 T
↓ 22 ↔ 30 cm



ART. 21449 I T
↓ 10 ↔ 17 cm



incasso T
ART. 22446 Ø 5
↓ 16 ↔ 10 cm



mezza vaschetta P
ART. 29309 P
↓ 17 ↔ 19 cm

ART. 29295 R/C
↓ 17 ↔ 19 cm

mezza vaschetta T
ART. 29315 P
↓ 17 ↔ 19 cm

ART. 29296 R/C
↓ 17 ↔ 19 cm



mezza lampada P
ART. 22285 Ø 5
↓ 20 ↔ 10 cm

ART. 22286 Ø 5 T
↓ 20 ↔ 10 cm



ART. 21249 P P
↓ 13 ↔ 7,5 cm



ART. 22249 Ø 4 P
↓ 12 ↔ 7,5 cm

Porcellana marmorizzata con inserti in acciaio inox 18/10



PORCELLANA



ART. 21422 P
↓ 28 ↔ 16,5 cm



ART. 21242 P
↓ 20 ↔ 13,5 cm



ART. 21462 P
↓ 12 ↔ 5,5 cm

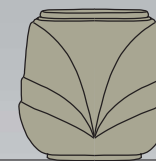

ART. 21417 P
↓ 15 ↔ 9 cm

ART. 29207 P
↓ 19 ↔ 18 cm

ART. 29423 P
↓ 19 ↔ 18 cm

ART. 21423 I
↓ 28 ↔ 16,5 cm

ART. 21241 I
↓ 20 ↔ 13,5 cm

ART. 21243 P
↓ 15 ↔ 9 cm

ART. 21414 R
↓ 15 ↔ 9 cm

ART. 29206 R/C
↓ 19 ↔ 18 cm

ART. 29422 R/C
↓ 19 ↔ 18 cm

ART. 21418 P
↓ 20 ↔ 13,5 cm

ART. 21246 R
↓ 15 ↔ 9 cm



ART. 22421 Ø 6
↓ 26 ↔ 13 cm

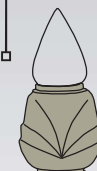

ART. 22242 Ø 5
↓ 20 ↔ 10 cm



ART. 22243 Ø 4
↓ 14 ↔ 8 cm



ART. 22951 P
↓ 17 ↔ 11 cm

ART. 22852 T
↓ 17 ↔ 11 cm

ART. 22419 Ø 5
↓ 20 ↔ 10 cm

ART. 22418 Ø 4
↓ 14 ↔ 8 cm

ART. 22853
↓ 23 ↔ 15 cm

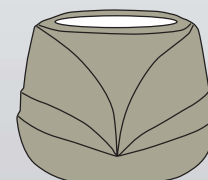

ART. 29525 T
↓ 22 ↔ 30 cm

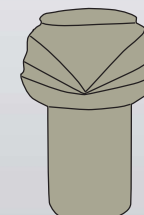

ART. 21449 I
↓ 10 ↔ 17 cm



incasso
ART. 22446 Ø 5
↓ 16 ↔ 10 cm

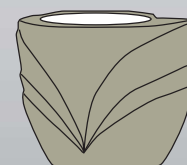

mezza vaschetta
ART. 29309 P
↓ 17 ↔ 19 cm

mezza vaschetta
ART. 29315 P
↓ 17 ↔ 19 cm



mezza lampada
ART. 22285 Ø 5
↓ 20 ↔ 10 cm



ART. 21249 P
↓ 13 ↔ 7,5 cm



ART. 22249 Ø 4
↓ 12 ↔ 7,5 cm

ART. 29295 R/C
↓ 17 ↔ 19 cm

ART. 29296 R/C
↓ 17 ↔ 19 cm

ART. 22286 Ø 5
↓ 20 ↔ 10 cm



Per ordinazioni aggiungere al codice articolo la sigla corrispondente alla colorazione scelta.
To place orders add to the article code the letter corresponding the selected colouring.



ART. 21363SD R/C
con staffa
↓ 24 ↔ 13 cm **P**

ART. 21163SD R/C
↓ 24 ↔ 13 cm **T**

ART. 21161SD R
↓ 28 ↔ 16 cm

ART. 21162SD I
↓ 32 ↔ 18 cm

ART. 21095SD R
↓ 40 ↔ 20 cm

ART. 21096SD R
↓ 50 ↔ 25 cm

ART. 21099SD R
↓ 60 ↔ 29 cm **T**



ART. 21360SD R
con staffa
↓ 20 ↔ 11 cm **P**

ART. 21368SD P
con staffa
↓ 18 ↔ 10 cm

ART. 21367SD R/C
con staffa
↓ 18 ↔ 10 cm

ART. 21359SD R/C
con staffa
↓ 15 ↔ 10 cm

ART. 21371SD P
con staffa
↓ 11 ↔ 6 cm **T**



ART. 21160SD R
↓ 20 ↔ 11 cm **T**

ART. 21168SD P
↓ 18 ↔ 10 cm

ART. 21167SD R/C
↓ 18 ↔ 10 cm

ART. 21159SD R/C
↓ 15 ↔ 10 cm **T**



ART. 29298SD R/C
con staffa
↓ 17 ↔ 15 cm **P**

ART. 29098SD R/C
↓ 17 ↔ 15 cm **T**

ART. 29014SD R
↓ 16 ↔ 22 cm **T**

ART. 29005SD R
↓ 17 ↔ 31 cm **T**



ART. 21310 P
↓ 18 ↔ 10 cm **P**

ART. 21311 R/C
↓ 18 ↔ 10 cm

ART. 21307 R
↓ 20 ↔ 11 cm

ART. 21306 R/C
↓ 24 ↔ 13 cm **T**



ART. 22310 Ø5
↓ 19 ↔ 9 cm **P**



ART. 29242 R/C
↓ 17 ↔ 15 cm **P**



ART. 26243 Ø5
↓ 20 ↔ 10 cm **P**

ART. 26042 Ø5
↓ 20 ↔ 10 cm **T**



ART. 27247 P
↓ 18,5 ↔ 14 cm **P**

ART. 27042 P
↓ 18,5 ↔ 14 cm **T**



ART. 22161SD Ø 6
↓ 27 ↔ 13 cm **T**



ART. 22360SD Ø 5
con staffa
↓ 19 ↔ 9 cm **P**

ART. 22359SD Ø 4
con staffa
↓ 14 ↔ 8 cm **T**



ART. 22160SD Ø 5
↓ 19 ↔ 9 cm **T**

ART. 22159SD Ø 4
↓ 14 ↔ 8 cm **T**



ART. 22951
con staffa
↓ 17 ↔ 11 cm **P**

ART. 22852
↓ 17 ↔ 11 cm **T**

ART. 22853
↓ 23 ↔ 15 cm **T**



ART. 22935 P
↓ 17 ↔ 11 cm **P**

Porcellana marmorizzata con inserti in acciaio inox 18/10



Per ordinazioni aggiungere al codice articolo la sigla corrispondente alla colorazione scelta.
To place orders add to the article code the letter corresponding the selected colouring.

PORCELLANA

| | | | | | |
|---|---|---|---|---|---|
| ART. 21363 R/C con staffa ↓ 24 ↔ 13 cm P | ART. 21163 R/C ↓ 24 ↔ 13 cm T ART. 21161 R ↓ 28 ↔ 16 cm ART. 21162 I ↓ 32 ↔ 18 cm ART. 21095 R ↓ 40 ↔ 20 cm ART. 21096 R ↓ 50 ↔ 25 cm ART. 21099 R ↓ 60 ↔ 29 cm | ART. 21360 R con staffa ↓ 20 ↔ 11 cm P ART. 21368 P con staffa ↓ 18 ↔ 10 cm ART. 21367 R/C con staffa ↓ 18 ↔ 10 cm ART. 21359 R/C con staffa ↓ 15 ↔ 10 cm ART. 21371 P con staffa ↓ 11 ↔ 6 cm | ART. 21160 R ↓ 20 ↔ 11 cm T ART. 21168 P ↓ 18 ↔ 10 cm ART. 21167 R/C ↓ 18 ↔ 10 cm ART. 21159 R/C ↓ 15 ↔ 10 cm | ART. 29298 R/C con staffa ↓ 17 ↔ 15 cm P ART. 29098 R/C ↓ 17 ↔ 15 cm T | ART. 29014 R ↓ 16 ↔ 22 cm T ART. 29005 R ↓ 17 ↔ 31 cm |
| ART. 21310 P ↓ 18 ↔ 10 cm P ART. 21311 R/C ↓ 18 ↔ 10 cm ART. 21307 R ↓ 20 ↔ 11 cm ART. 21306 R/C ↓ 24 ↔ 13 cm | ART. 22310 Ø 5 ↓ 19 ↔ 9 cm P | ART. 29242 R/C ↓ 17 ↔ 15 cm P | ART. 26243 Ø 5 ↓ 20 ↔ 10 cm P ART. 26042 Ø 5 ↓ 20 ↔ 10 cm T | ART. 27247 P ↓ 18,5 ↔ 14 cm P ART. 27042 P ↓ 18,5 ↔ 14 cm T | |
| ART. 22161 Ø 6 ↓ 27 ↔ 13 cm T | ART. 22360 Ø 5 con staffa ↓ 19 ↔ 9 cm P ART. 22359 Ø 4 con staffa ↓ 14 ↔ 8 cm | ART. 22160 Ø 5 ↓ 19 ↔ 9 cm T ART. 22159 Ø 4 ↓ 14 ↔ 8 cm | ART. 22951 con staffa ↓ 17 ↔ 11 cm P ART. 22853 ↓ 23 ↔ 15 cm | ART. 22852 ↓ 17 ↔ 11 cm T | ART. 22935 P ↓ 17 ↔ 11 cm P |



ART. 21363 R/C
con staffa
↓ 24 ↔ 13 cm **P**

ART. 21163 R/C
↓ 24 ↔ 13 cm **T**

ART. 21161 R
↓ 28 ↔ 16 cm

ART. 21162 I
↓ 32 ↔ 18 cm

ART. 21095 R
↓ 40 ↔ 20 cm

ART. 21096 R
↓ 50 ↔ 25 cm

ART. 21099 R
↓ 60 ↔ 29 cm

ART. 21360 R
con staffa
↓ 20 ↔ 11 cm **P**

ART. 21368 P
con staffa
↓ 18 ↔ 10 cm

ART. 21367 R/C
con staffa
↓ 18 ↔ 10 cm

ART. 21359 R/C
con staffa
↓ 15 ↔ 10 cm

ART. 21371 P
con staffa
↓ 11 ↔ 6 cm

ART. 21160 R
↓ 20 ↔ 11 cm **T**

ART. 21168 P
↓ 18 ↔ 10 cm

ART. 21167 R/C
↓ 18 ↔ 10 cm

ART. 21159 R/C
↓ 15 ↔ 10 cm

ART. 29298 R/C
con staffa
↓ 17 ↔ 15 cm **P**

ART. 29098 R/C
↓ 17 ↔ 15 cm **T**

ART. 29014 R
↓ 16 ↔ 22 cm **T**

ART. 29005 R
↓ 17 ↔ 31 cm



ART. 22161 Ø 6
↓ 27 ↔ 13 cm **T**

ART. 22360 Ø 5
con staffa
↓ 19 ↔ 9 cm **P**

ART. 22359 Ø 4
con staffa
↓ 14 ↔ 8 cm

ART. 22160 Ø 5
↓ 19 ↔ 9 cm **T**

ART. 22159 Ø 4
↓ 14 ↔ 8 cm

ART. 22840
con staffa
↓ 17 ↔ 11 cm **P**

ART. 22841
↓ 17 ↔ 11 cm **T**

ART. 22842
↓ 23 ↔ 15 cm

ART. 26248 Ø 5
↓ 20 ↔ 10 cm **P**

ART. 26043 Ø 5
↓ 20 ↔ 10 cm **T**

ART. 27248 P
↓ 18,5 ↔ 14 cm **P**

ART. 27043 P
↓ 18,5 ↔ 14 cm **T**



ART. 20458 7x9 cm
ART. 20459 8x10 cm
ART. 20455 9x12 cm
ART. 20456 11x15 cm
ART. 20457 13x18 cm

ART. 20465 9x12 cm
ART. 20466 10x15 cm
ART. 20467 11x15 cm
ART. 20468 13x18 cm

ART. 20050 9x12 cm
ART. 20051 11x15 cm
ART. 20052 13x18 cm

ART. 20053 9x12 cm
ART. 20054 10x15 cm
ART. 20055 11x15 cm
ART. 20056 13x18 cm

ART. 24030 10x6 cm
ART. 24031 15x9 cm
ART. 24032 20x11 cm
ART. 24033 30x14 cm
ART. 24049 40x15 cm



ART. 21289 R/C con staffa
↓ 24 ↔ 13 cm



ART. 21203 R con staffa
↓ 20 ↔ 11 cm
ART. 21389 P con staffa
↓ 18 ↔ 10 cm
ART. 21304 R/C con staffa
↓ 18 ↔ 10 cm
ART. 21287 R/C con staffa
↓ 15 ↔ 10 cm
ART. 21384 R/C con staffa
↓ 11 ↔ 6 cm



ART. 21103 R
↓ 20 ↔ 11 cm



ART. 21189 P
↓ 18 ↔ 10 cm

ART. 21074 R
↓ 28 ↔ 16 cm

ART. 21073 I
↓ 32 ↔ 18 cm

ART. 29366 R/C con staffa
↓ 17 ↔ 15 cm

ART. 29266 R/C
↓ 17 ↔ 15 cm

ART. 29268 R
↓ 16 ↔ 22 cm
ART. 29269 R
↓ 17 ↔ 31 cm



ART. 22074 Ø 6
↓ 27 ↔ 13 cm



ART. 22206 Ø 5 con staffa
↓ 19 ↔ 9 cm

ART. 22103 Ø 5
↓ 19 ↔ 9 cm



ART. 22287 Ø 4 con staffa
↓ 14 ↔ 8 cm



ART. 22933 con staffa
↓ 17 ↔ 11 cm

ART. 26249 Ø 5
↓ 20 ↔ 10 cm

ART. 27249 P
↓ 18,5 ↔ 14 cm



ART. 22833 T
↓ 17 ↔ 11 cm
ART. 22834
↓ 23 ↔ 15 cm



ART. 20806 7x9 cm
ART. 20807 8x10 cm
ART. 20808 9x12 cm
ART. 20809 11x15 cm
ART. 20810 13x18 cm



ART. 20816 9x12 cm
ART. 20817 10x15 cm
ART. 20818 11x15 cm
ART. 20819 13x18 cm



ART. 20583 9x12 cm
ART. 20584 11x15 cm
ART. 20585 13x18 cm



ART. 20565 9x12 cm
ART. 20566 10x15 cm
ART. 20567 11x15 cm
ART. 20568 13x18 cm



ART. 21071SD R/C T
↓ 28 ↔ 15 cm



ART. 21272SD P P
↓ 20 ↔ 11 cm

ART. 21072SD P T
↓ 20 ↔ 11 cm



ART. 21264SD P P
↓ 17 ↔ 9 cm

ART. 21064SD P T
↓ 17 ↔ 9 cm

ART. 21269SD R/C
↓ 17 ↔ 9 cm

ART. 21069SD R/C
↓ 17 ↔ 9 cm

ART. 21233SD P
↓ 11 ↔ 7 cm

ART. 21067SD P
↓ 11 ↔ 7 cm

ART. 21268SD R
↓ 13 ↔ 7 cm

ART. 21068SD R
↓ 13 ↔ 7 cm



ART. 22071SD Ø 6 T
↓ 24 ↔ 13 cm



ART. 22270SD Ø 5 P
↓ 19 ↔ 8 cm



ART. 22268SD Ø 4 P
↓ 13 ↔ 7 cm



ART. 22970SD P
↓ 17 ↔ 11 cm

ART. 22870SD T
↓ 17 ↔ 11 cm

ART. 22070SD Ø 5 T
↓ 19 ↔ 8 cm

ART. 22068SD Ø 4 T
↓ 13 ↔ 7 cm

ART. 22871SD
↓ 21 ↔ 14 cm



ART. 29371SD P P
↓ 17 ↔ 16 cm

ART. 29071SD P T
↓ 17 ↔ 16 cm

ART. 29373SD P P
↓ 17 ↔ 31 cm

ART. 29073SD P T
↓ 17 ↔ 31 cm

mezza vaschetta P
ART. 29330SD P
↓ 16 ↔ 27 cm

ART. 29370SD R/C
↓ 17 ↔ 16 cm

ART. 29070SD R/C
↓ 17 ↔ 16 cm

ART. 29372SD R/C
↓ 17 ↔ 31 cm

ART. 29072SD R/C
↓ 17 ↔ 31 cm



ART. 29068SD R T
↓ 13 ↔ 21 cm

ART. 29069SD R
↓ 18 ↔ 30 cm

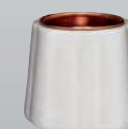

ART. 29267SD R P
↓ 10 ↔ 11 cm

ART. 29067SD R T
↓ 10 ↔ 11 cm

Porcellana marmorizzata con inserti in acciaio inox 18/10



PORCELLANA

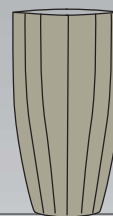

ART. 21071 R/C **T**
↓ 28 ↔ 15 cm



ART. 21272 P **P** ART. 21072 P **T**
↓ 20 ↔ 11 cm ↓ 20 ↔ 11 cm



ART. 21264 P **P** ART. 21064 P **T**
↓ 17 ↔ 9 cm ↓ 17 ↔ 9 cm
ART. 21269 R/C ↓ 17 ↔ 9 cm
ART. 21268 R ↓ 13 ↔ 7 cm
ART. 21233 P ↓ 11 ↔ 7 cm
ART. 21069 R/C ↓ 17 ↔ 9 cm
ART. 21068 R ↓ 13 ↔ 7 cm
ART. 21067 P ↓ 11 ↔ 7 cm



ART. 22071 Ø 6 **T**
↓ 24 ↔ 13 cm



ART. 22270 Ø 5 **P**
↓ 19 ↔ 8 cm



ART. 22268 Ø 4 **P**
↓ 13 ↔ 7 cm

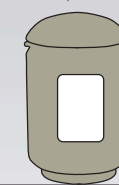

ART. 22970 4GG **P** ART. 22870 4GG **T**
↓ 17 ↔ 11 cm ↓ 17 ↔ 11 cm

ART. 22070 Ø 5 **T**
↓ 19 ↔ 8 cm

ART. 22068 Ø 4 **T**
↓ 13 ↔ 7 cm

ART. 22871 6GG
↓ 21 ↔ 14 cm

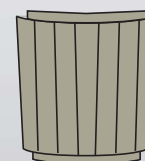

ART. 29371 P **P** ART. 29071 P **T**
↓ 17 ↔ 16 cm ↓ 17 ↔ 16 cm

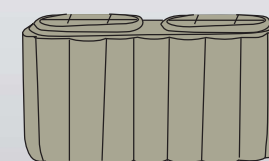

ART. 29373 P **P** ART. 29073 P **T**
↓ 17 ↔ 31 cm ↓ 17 ↔ 31 cm

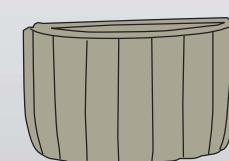

mezza vaschetta **P**
ART. 29330 P
↓ 16 ↔ 27 cm

ART. 29370 R/C ↓ 17 ↔ 16 cm

ART. 29070 R/C ↓ 17 ↔ 16 cm

ART. 29372 R/C ↓ 17 ↔ 31 cm

ART. 29072 R/C ↓ 17 ↔ 31 cm



Per ordinazioni aggiungere al codice articolo la sigla corrispondente alla colorazione scelta.
To place orders add to the article code the letter corresponding the selected colouring.

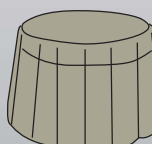

ART. 29068 R **T**
↓ 13 ↔ 21 cm
ART. 29069 R
↓ 18 ↔ 30 cm

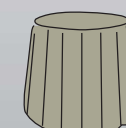

ART. 29267 R **P** ART. 29067 R **T**
↓ 10 ↔ 11 cm ↓ 10 ↔ 11 cm



ART. 21071 R/C
↓ 28 ↔ 15 cm



ART. 21272 P
↓ 20 ↔ 11 cm



ART. 21072 P
↓ 20 ↔ 11 cm



ART. 21264 P
↓ 17 ↔ 9 cm



ART. 21064 P
↓ 17 ↔ 9 cm

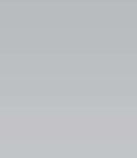

ART. 21233 P
↓ 11 ↔ 7 cm



ART. 21067 P
↓ 11 ↔ 7 cm

ART. 21270 R/C
↓ 20 ↔ 11 cm

ART. 21070 R/C
↓ 20 ↔ 11 cm

ART. 21269 R/C
↓ 17 ↔ 9 cm

ART. 21069 R/C
↓ 17 ↔ 9 cm

ART. 21268 R
↓ 13 ↔ 7 cm

ART. 21068 R
↓ 13 ↔ 7 cm



ART. 29371 P
↓ 17 ↔ 16 cm

ART. 29071 P
↓ 17 ↔ 16 cm

ART. 22071 Ø 6
↓ 24 ↔ 13 cm

ART. 22270 Ø 5
↓ 19 ↔ 8 cm

ART. 22268 Ø 4
↓ 13 ↔ 7 cm

ART. 22970 P
↓ 17 ↔ 11 cm

ART. 22870 T
↓ 17 ↔ 11 cm

ART. 29370 R/C
↓ 17 ↔ 16 cm

ART. 29070 R/C
↓ 17 ↔ 16 cm

ART. 22070 Ø 5
↓ 19 ↔ 8 cm

ART. 22068 Ø 4
↓ 13 ↔ 7 cm

ART. 22871
↓ 21 ↔ 14 cm



ART. 29373 P
↓ 17 ↔ 31 cm

ART. 29073 P
↓ 17 ↔ 31 cm

ART. 29330 P
↓ 16 ↔ 27 cm

ART. 29068 R
↓ 13 ↔ 21 cm

ART. 29069 R
↓ 18 ↔ 30 cm

ART. 29267 R
↓ 10 ↔ 11 cm

ART. 29067 R
↓ 10 ↔ 11 cm

ART. 29372 R/C
↓ 17 ↔ 31 cm

ART. 29072 R/C
↓ 17 ↔ 31 cm



ART. 20318 7x9 cm
ART. 20319 8x10 cm
ART. 20320 9x12 cm
ART. 20321 11x15 cm
ART. 20322 13x18 cm



ART. 20325 9x12 cm
ART. 20326 10x15 cm
ART. 20327 11x15 cm
ART. 20328 13x18 cm



ART. 20497 9x12 cm
ART. 20498 11x15 cm
ART. 20499 13x18 cm



ART. 20536 9x12 cm
ART. 20537 10x15 cm
ART. 20538 11x15 cm
ART. 20539 13x18 cm



ART. 24102
↓ 10 ↔ 6 cm
ART. 24103
↓ 15 ↔ 9 cm
ART. 24104
↓ 20 ↔ 11 cm
ART. 24105
↓ 30 ↔ 14 cm
ART. 24106
↓ 40 ↔ 15 cm

Porcellana Apuania con intarsio + inserti acciaio inox 18/10



ART. 21317 R/C **P** ↓ 20 ↔ 11 cm
 ART. 21319 R ↓ 17 ↔ 9 cm
 ART. 21324 R ↓ 13 ↔ 7 cm

ART. 21015 R/C **T** ↓ 28 ↔ 15 cm
 ART. 21017 R/C ↓ 20 ↔ 11 cm
 ART. 21019 R ↓ 17 ↔ 9 cm
 ART. 21023 R ↓ 13 ↔ 7 cm

ART. 21313 R/C **P** ↓ 20 ↔ 11 cm
 ART. 21301 R ↓ 17 ↔ 9 cm
 ART. 21308 R ↓ 13 ↔ 7 cm

ART. 21016 R/C **T** ↓ 28 ↔ 15 cm
 ART. 21014 R/C ↓ 20 ↔ 11 cm
 ART. 21021 R ↓ 17 ↔ 9 cm
 ART. 21018 R ↓ 13 ↔ 7 cm



ART. 22321 Ø 5 **P** ↓ 19 ↔ 8 cm
 ART. 22309 Ø 4 ↓ 13 ↔ 7 cm

ART. 22029 Ø 6 **T** ↓ 24 ↔ 13 cm
 ART. 22021 Ø 5 ↓ 19 ↔ 8 cm
 ART. 22009 Ø 4 ↓ 13 ↔ 7 cm

ART. 29516 R/C **P** ↓ 17 ↔ 16 cm
 ART. 29316 R/C **T** ↓ 17 ↔ 16 cm

ART. 29513 R/C **P** ↓ 17 ↔ 16 cm
 ART. 29313 R/C **T** ↓ 17 ↔ 16 cm

ART. 22313 Ø 5 **P** ↓ 19 ↔ 8 cm
 ART. 22301 Ø 4 ↓ 13 ↔ 7 cm

ART. 22008 Ø 6 **T** ↓ 24 ↔ 13 cm
 ART. 22014 Ø 5 ↓ 19 ↔ 8 cm
 ART. 22041 Ø 4 ↓ 13 ↔ 7 cm



ART. 22904 **P** ↓ 17 ↔ 11 cm

ART. 22804 **T** ↓ 17 ↔ 11 cm

ART. 29518 R/C **P** ↓ 17 ↔ 31 cm

ART. 29521 R **P** ↓ 10 ↔ 11 cm

ART. 29323 R **T** ↓ 18 ↔ 30 cm
 ART. 29322 R ↓ 13 ↔ 21 cm
 ART. 29321 P ↓ 10 ↔ 11 cm

ART. 29527 R **P** ↓ 10 ↔ 11 cm

ART. 29329 R **T** ↓ 18 ↔ 30 cm
 ART. 29328 R ↓ 13 ↔ 21 cm
 ART. 29327 P ↓ 10 ↔ 11 cm

ART. 29512 R/C **P** ↓ 17 ↔ 31 cm

ART. 22932 **P** ↓ 17 ↔ 11 cm

ART. 22831 **T** ↓ 17 ↔ 11 cm

ART. 22805 ↓ 21 ↔ 14 cm

ART. 29318 R/C **T** ↓ 17 ↔ 31 cm

ART. 22832 ↓ 21 ↔ 14 cm



ART. 20355 7x9 cm
 ART. 20356 8x10 cm
 ART. 20357 9x12 cm
 ART. 20358 11x15 cm
 ART. 20359 13x18 cm

ART. 20360 9x12 cm
 ART. 20361 10x15 cm
 ART. 20362 11x15 cm
 ART. 20363 13x18 cm

ART. 20540 9x12 cm
 ART. 20541 10x15 cm
 ART. 20542 11x15 cm
 ART. 20546 13x18 cm

ART. 20543 9x12 cm
 ART. 20544 10x15 cm
 ART. 20545 11x15 cm
 ART. 20546 13x18 cm

ART. 24210 ↓ 10 ↔ 6 cm
 ART. 24211 ↓ 15 ↔ 9 cm
 ART. 24212 ↓ 20 ↔ 11 cm
 ART. 24213 ↓ 30 ↔ 14 cm
 ART. 24214 ↓ 40 ↔ 15 cm

ART. 20391 7x9 cm
 ART. 20392 8x10 cm
 ART. 20393 9x12 cm
 ART. 20394 11x15 cm
 ART. 20395 13x18 cm

ART. 20382 9x12 cm
 ART. 20383 10x15 cm
 ART. 20384 11x15 cm
 ART. 20385 13x18 cm

ART. 20580 9x12 cm
 ART. 20581 10x15 cm
 ART. 20582 11x15 cm
 ART. 20586 13x18 cm

ART. 20561 9x12 cm
 ART. 20562 10x15 cm
 ART. 20563 11x15 cm
 ART. 20564 13x18 cm

ART. 24225 ↓ 10 ↔ 6 cm
 ART. 24226 ↓ 15 ↔ 9 cm
 ART. 24227 ↓ 20 ↔ 11 cm
 ART. 24228 ↓ 30 ↔ 14 cm
 ART. 24229 ↓ 40 ↔ 15 cm

Porcellana Alpi con intarsio + inserti acciaio inox 18/10



PORCELLANA



ART. 21029SD P T
↓ 29 ↔ 15 cm



ART. 21007SD P P
↓ 22 ↔ 12 cm



ART. 21009SD P P
↓ 19 ↔ 10 cm

ART. 21028SD P T
↓ 19 ↔ 10 cm



ART. 29212SD P P
↓ 18 ↔ 17 cm

ART. 21027SD P T
↓ 22 ↔ 12 cm

ART. 21207SD P P
↓ 13,5 ↔ 7,5 cm

ART. 21025SD P P
↓ 13,5 ↔ 7,5 cm

ART. 29112SD P T
↓ 18 ↔ 17 cm



ART. 29251SD R T
↓ 16 ↔ 17 cm

ART. 29252SD R
↓ 18 ↔ 19 cm



ART. 22106SD Ø 6 T
↓ 27 ↔ 13 cm



ART. 22225SD Ø 5 P
↓ 22 ↔ 9 cm



ART. 22105SD Ø 5 T
↓ 22 ↔ 9 cm



ART. 22224SD Ø 5 P
↓ 19 ↔ 8 cm

ART. 22222SD Ø 4
↓ 15 ↔ 7 cm

ART. 22104SD Ø 5 T
↓ 19 ↔ 8 cm

ART. 22132SD Ø 4
↓ 15 ↔ 7 cm



ART. 22951 P
↓ 17 ↔ 11 cm

ART. 22852 T
↓ 17 ↔ 11 cm

ART. 22853
↓ 23 ↔ 15 cm



ART. 20153 7x9 cm
ART. 20154 8x10 cm
ART. 20263 9x12 cm
ART. 20264 11x15 cm
ART. 20265 13x18 cm



ART. 20323 7x9 cm
ART. 20324 8x10 cm
ART. 20345 9x12 cm
ART. 20346 10x15 cm
ART. 20347 11x15 cm
ART. 20348 13x18 cm



ART. 20898 9x12 cm
ART. 20899 11x15 cm
ART. 20900 13x18 cm



ART. 20901 9x12 cm
ART. 20902 10x15 cm
ART. 20909 11x15 cm
ART. 20910 13x18 cm



ART. 24195
↓ 10 ↔ 6 cm
ART. 24196
↓ 15 ↔ 9 cm
ART. 24197
↓ 20 ↔ 11 cm
ART. 24198
↓ 30 ↔ 14 cm
ART. 24199
↓ 40 ↔ 15 cm

Porcellana marmorizzata con inserti in acciaio inox 18/10



PORCELLANA



ART. 21076 P
↓ 29 ↔ 15 cm



ART. 21276 P
↓ 22 ↔ 12 cm



ART. 21277 P
↓ 19 ↔ 10 cm



ART. 21078 P
↓ 19 ↔ 10 cm

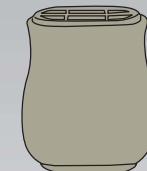

ART. 29275 P
↓ 18 ↔ 17 cm

ART. 21077 P
↓ 22 ↔ 12 cm

ART. 21278 P
↓ 13,5 ↔ 7,5 cm

ART. 21079 P
↓ 13,5 ↔ 7,5 cm

ART. 29075 P
↓ 18 ↔ 17 cm

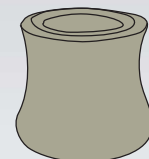

ART. 29251 R
↓ 16 ↔ 17 cm

ART. 29252 R
↓ 18 ↔ 19 cm



ART. 22076 Ø 6
↓ 27 ↔ 13 cm



ART. 22277 Ø 5
↓ 19 ↔ 8 cm

ART. 22278 Ø 4
↓ 15 ↔ 7 cm



ART. 22251 Ø 5
↓ 16 ↔ 9,5 cm

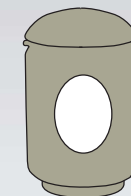

ART. 22935
↓ 17 ↔ 11 cm

ART. 22852
↓ 17 ↔ 11 cm

ART. 22853
↓ 23 ↔ 15 cm



Per ordinazioni aggiungere al codice articolo la sigla corrispondente alla colorazione scelta.
To place orders add to the article code the letter corresponding the selected colouring.



ART. 20153 7x9 cm
ART. 20154 8x10 cm
ART. 20263 9x12 cm
ART. 20264 11x15 cm
ART. 20265 13x18 cm

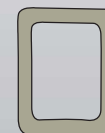

ART. 20323 7x9 cm
ART. 20324 8x10 cm
ART. 20345 9x12 cm
ART. 20346 10x15 cm
ART. 20347 11x15 cm
ART. 20348 13x18 cm

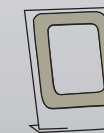

ART. 20898 9x12 cm
ART. 20899 11x15 cm
ART. 20900 13x18 cm

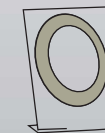

ART. 20901 9x12 cm
ART. 20902 10x15 cm
ART. 20909 11x15 cm
ART. 20910 13x18 cm

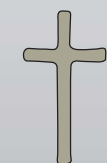

ART. 24195
↓ 10 ↔ 6 cm
ART. 24196
↓ 15 ↔ 9 cm
ART. 24197
↓ 20 ↔ 11 cm
ART. 24198
↓ 30 ↔ 14 cm
ART. 24199
↓ 40 ↔ 15 cm



ART. 21076 P T
↓ 29 ↔ 15 cm



ART. 21276 P P
↓ 22 ↔ 19 cm



ART. 21277 P P
↓ 19 ↔ 10 cm



ART. 21278 P P
↓ 13,5 ↔ 7,5 cm



ART. 29275 P P
↓ 18 ↔ 17 cm

ART. 21077 P T
↓ 22 ↔ 19 cm

ART. 21078 P T
↓ 19 ↔ 10 cm

ART. 21079 P T
↓ 13,5 ↔ 7,5 cm

ART. 29075 P T
↓ 18 ↔ 17 cm



ART. 22076 Ø 6 T
↓ 27 ↔ 13 cm



ART. 22277 Ø 5 P
↓ 19 ↔ 8 cm



ART. 22278 Ø 4 P
↓ 15 ↔ 7 cm



ART. 22241 Ø 5 P
↓ 21 ↔ 15 cm



ART. 29241 P
↓ 19 ↔ 19 cm

ART. 22077 Ø 5 T
↓ 19 ↔ 8 cm



ART. 29251 R T
↓ 16 ↔ 17 cm



ART. 22251 Ø 5 T
↓ 16 ↔ 9,5 cm



ART. 22910 P
↓ 17 ↔ 11 cm



ART. 22808 T
↓ 17 ↔ 11 cm



ART. 21102 P T
↓ 6 ↔ 18 cm

ART. 22102 Ø 5 T
↓ 6 ↔ 12 cm

ART. 29252 R
↓ 18 ↔ 19 cm

ART. 22809
↓ 23 ↔ 15 cm



ART. 20373 7x9 cm
ART. 20374 8x10 cm
ART. 20375 9x12 cm
ART. 20376 11x15 cm
ART. 20377 13x18 cm



ART. 20378 9x12 cm
ART. 20379 10x15 cm
ART. 20380 11x15 cm
ART. 20381 13x18 cm



ART. 20554 9x12 cm
ART. 20555 11x15 cm
ART. 20556 13x18 cm



ART. 20557 9x12 cm
ART. 20558 10x15 cm
ART. 20559 11x15 cm
ART. 20560 13x18 cm



ART. 24220
↓ 10 ↔ 6 cm
ART. 24221
↓ 15 ↔ 9 cm
ART. 24222
↓ 20 ↔ 11 cm
ART. 24223
↓ 30 ↔ 14 cm
ART. 24224
↓ 40 ↔ 15 cm



ART. 21401 R/C
↓ 28 ↔ 15 cm



ART. 21407 R/C
Sinistro
↓ 19 ↔ 18 cm



ART. 22409 Ø 5
Centrale
↓ 20 ↔ 16 cm



ART. 21408 R/C
Destro
↓ 19 ↔ 18 cm



ART. 22401 R/C
Ø 6 ↓ 27 ↔ 14 cm



ART. 29407 R/C
Sinistro
↓ 19 ↔ 21 cm



ART. 25210 ↓ 11 ↔ 15 cm
ART. 25211 ↓ 14 ↔ 20 cm
ART. 25212 ↓ 18 ↔ 25 cm
ART. 25213 ↓ 22 ↔ 30 cm
ART. 25214 ↓ 29 ↔ 40 cm



ART. 29408 R/C
Destro
↓ 19 ↔ 21 cm



ART. 22902 P
↓ 17 ↔ 11 cm

ART. 22802 T
↓ 17 ↔ 11 cm
ART. 22803
↓ 23 ↔ 15 cm



ART. 22407 R/C
Sinistro
↓ 20 ↔ 12,5 cm



ART. 29409 R/C
Destro
↓ 19,5 ↔ 43,5 cm



ART. 22408 R/C
Destro
↓ 20 ↔ 12,5 cm



ART. 20329 9x12 cm
ART. 20330 11x15 cm
ART. 20331 13x18 cm



ART. 20332 9x12 cm
ART. 20333 10x15 cm
ART. 20334 11x15 cm
ART. 20335 13x18 cm



ART. 24185 ↓ 10 ↔ 6 cm
ART. 24186 ↓ 15 ↔ 9 cm
ART. 24187 ↓ 20 ↔ 11 cm
ART. 24188 ↓ 30 ↔ 14 cm
ART. 24189 ↓ 40 ↔ 18 cm

Porcellana bianca con inserti in acciaio inox 18/10

Porcellana marmorizzata con inserti in acciaio inox 18/10



ART. 27401 P $\downarrow 20 \leftrightarrow 10,5$ cm
 ART. 27101 P $\downarrow 20 \leftrightarrow 10,5$ cm
 ART. 27400 I $\downarrow 20 \leftrightarrow 10,5$ cm
 ART. 27100 I $\downarrow 20 \leftrightarrow 10,5$ cm



ART. 26401 Ø 5 $\downarrow 19,5 \leftrightarrow 8,5$ cm
 ART. 26101 Ø 5 $\downarrow 19,5 \leftrightarrow 8,5$ cm



mezza vaschetta
 ART. 29166 P $\downarrow 17 \leftrightarrow 28$ cm



mezza lampada
 ART. 26032 Ø 5 $\downarrow 20 \leftrightarrow 11$ cm



ART. 29425 P $\downarrow 19 \leftrightarrow 16$ cm
 ART. 29121 P $\downarrow 19 \leftrightarrow 16$ cm
 ART. 29424 R/C $\downarrow 19 \leftrightarrow 16$ cm
 ART. 29120 R/C $\downarrow 19 \leftrightarrow 16$ cm



ART. 20153 7x9 cm
 ART. 20154 8x10 cm
 ART. 20263 9x12 cm
 ART. 20264 11x15 cm
 ART. 20265 13x18 cm



ART. 20323 7x9 cm
 ART. 20324 8x10 cm
 ART. 20345 9x12 cm
 ART. 20346 10x15 cm
 ART. 20347 11x15 cm
 ART. 20348 13x18 cm



ART. 24195 $\downarrow 10 \leftrightarrow 6$ cm
 ART. 24196 $\downarrow 15 \leftrightarrow 9$ cm
 ART. 24197 $\downarrow 20 \leftrightarrow 11$ cm
 ART. 24198 $\downarrow 30 \leftrightarrow 14$ cm
 ART. 24199 $\downarrow 40 \leftrightarrow 15$ cm

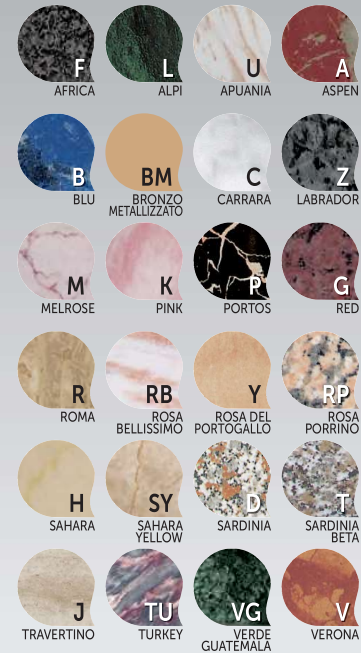

PORCELLANA



mezza lampada
 ART. 26032 Ø 5 $\downarrow 20 \leftrightarrow 11$ cm



mezza vaschetta
 ART. 29166 P $\downarrow 17 \leftrightarrow 28$ cm



ART. 26401 Ø 5 $\downarrow 19,5 \leftrightarrow 8,5$ cm
 ART. 26101 Ø 5 $\downarrow 19,5 \leftrightarrow 8,5$ cm



ART. 27401 P $\downarrow 20 \leftrightarrow 10,5$ cm
 ART. 27101 P $\downarrow 20 \leftrightarrow 10,5$ cm
 ART. 27400 I $\downarrow 20 \leftrightarrow 10,5$ cm
 ART. 27100 I $\downarrow 20 \leftrightarrow 10,5$ cm



ART. 29425 P $\downarrow 19 \leftrightarrow 16$ cm
 ART. 29121 P $\downarrow 19 \leftrightarrow 16$ cm
 ART. 29424 R/C $\downarrow 19 \leftrightarrow 16$ cm
 ART. 29120 R/C $\downarrow 19 \leftrightarrow 16$ cm



ART. 20153 7x9 cm
 ART. 20154 8x10 cm
 ART. 20263 9x12 cm
 ART. 20264 11x15 cm
 ART. 20265 13x18 cm



ART. 20323 7x9 cm
 ART. 20324 8x10 cm
 ART. 20345 9x12 cm
 ART. 20346 10x15 cm
 ART. 20347 11x15 cm
 ART. 20348 13x18 cm



ART. 24195 $\downarrow 10 \leftrightarrow 6$ cm
 ART. 24196 $\downarrow 15 \leftrightarrow 9$ cm
 ART. 24197 $\downarrow 20 \leftrightarrow 11$ cm
 ART. 24198 $\downarrow 30 \leftrightarrow 14$ cm
 ART. 24199 $\downarrow 40 \leftrightarrow 15$ cm

Per ordinazioni aggiungere al codice articolo la sigla corrispondente alla colorazione scelta.
 To place orders add to the article code the letter corresponding to the selected colouring.

Porcellana smalto bianco con inserti in acciaio inox 18/10



ART. 21385 P
↓ 20 ↔ 12 cm

ART. 21485 P T
↓ 20 ↔ 12 cm



ART. 21387 P
↓ 13 ↔ 8 cm
ART. 21388 P
↓ 11 ↔ 5 cm



ART. 29744 P
↓ 17 ↔ 16 cm

ART. 29944 P T
↓ 17 ↔ 16 cm



ART. 29744 P
↓ 17 ↔ 16 cm

ART. 29944 P T
↓ 17 ↔ 16 cm



ART. 21387 P
↓ 12 ↔ 8 cm
ART. 21388 P
↓ 11 ↔ 5 cm



ART. 21385 P
↓ 20 ↔ 12 cm

ART. 21485 P T
↓ 20 ↔ 12 cm



ART. 22487 Ø 4 P
↓ 11 ↔ 6 cm



ART. 22385 Ø 5 P
↓ 18 ↔ 9 cm

ART. 22485 Ø 5 T
↓ 18 ↔ 9 cm



ART. 22385 Ø 5 P
↓ 18 ↔ 9 cm

ART. 22485 Ø 5 T
↓ 18 ↔ 9 cm



ART. 22487 Ø 4 P
↓ 11 ↔ 6 cm

Porcellana smalto bianco marmorizzata con inserti in acciaio inox 18/10



PORCELLANA

Per ordinazioni aggiungere al codice articolo la sigla corrispondente alla colorazione scelta.
To place orders add to the article code the letter corresponding the selected colouring.

Porcellana smalto bianco con inserti in acciaio inox 18/10



ART. 21279 P
↓ 21 ↔ 12 cm

ART. 21297 P
↓ 14 ↔ 8 cm

ART. 21299 P
↓ 12 ↔ 6,5 cm

ART. 21092 T
↓ 21 ↔ 12 cm

ART. 21111 P
↓ 14 ↔ 8 cm



ART. 29880 P
↓ 19 ↔ 18 cm

ART. 29728 T
↓ 19 ↔ 18 cm

ART. 22207 Ø 5
↓ 19 ↔ 9 cm

ART. 22004 Ø 5
↓ 19 ↔ 9 cm

ART. 22297 Ø 4
↓ 14 ↔ 7,5 cm

ART. 22110 Ø 4
↓ 14 ↔ 7,5 cm



ART. 22207 Ø 5
↓ 19 ↔ 9 cm

ART. 22004 Ø 5
↓ 19 ↔ 9 cm

ART. 22297 Ø 4
↓ 14 ↔ 7,5 cm

ART. 22110 Ø 4
↓ 14 ↔ 7,5 cm

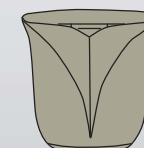

ART. 29880 P
↓ 19 ↔ 18 cm

ART. 29728 T
↓ 19 ↔ 18 cm



ART. 21279 P
↓ 21 ↔ 12 cm

ART. 21092 T
↓ 21 ↔ 12 cm

ART. 21297 P
↓ 14 ↔ 8 cm

ART. 21111 P
↓ 14 ↔ 8 cm

ART. 21299 P
↓ 12 ↔ 6,5 cm



ART. 200134 9x12 cm
ART. 200135 12x15 cm
ART. 200136 13x18 cm



ART. 200137 9x12 cm
ART. 200138 12x15 cm
ART. 200139 13x18 cm



ART. 200134 9x12 cm
ART. 200135 12x15 cm
ART. 200136 13x18 cm



ART. 200137 9x12 cm
ART. 200138 12x15 cm
ART. 200139 13x18 cm

Porcellana smalto bianco marmorizzata con inserti in acciaio inox 18/10



PORCELLANA

Per ordinazioni aggiungere al codice articolo la sigla corrispondente alla colorazione scelta.
To place orders add to the article code the letter corresponding the selected colouring.

NOVITÀ

PORCELLANA



Porcellana smalto bianco con decoro color platino



Porcellana smalto bianco con decoro color oro



Porcellana ivory con decoro color oro



Porcellana ivory



P ART. 27674 P ↓ 21 ↔ 12 cm

T ART. 27722 P ↓ 21 ↔ 12 cm



P ART. 27677 P ↓ 21 ↔ 12 cm

T ART. 27724 P ↓ 21 ↔ 12 cm



P ART. 27680 P ↓ 21 ↔ 12 cm

T ART. 27726 P ↓ 21 ↔ 12 cm



P ART. 21717 P ↓ 21 ↔ 12 cm

T ART. 21117 P ↓ 21 ↔ 12 cm



P ART. 27676 P ↓ 12 ↔ 6,5 cm
ART. 27675 P ↓ 14 ↔ 8 cm

T ART. 27723 P ↓ 14 ↔ 8 cm



P ART. 27679 P ↓ 12 ↔ 6,5 cm
ART. 27678 P ↓ 14 ↔ 8 cm

T ART. 27725 P ↓ 14 ↔ 8 cm



P ART. 27682 P ↓ 12 ↔ 6,5 cm
ART. 27681 P ↓ 14 ↔ 8 cm

T ART. 27727 P ↓ 14 ↔ 8 cm



P ART. 21793 P ↓ 12 ↔ 6,5 cm
ART. 21792 P ↓ 14 ↔ 8 cm

T ART. 21192 P ↓ 14 ↔ 8 cm



P ART. 29885 P ↓ 19 ↔ 18 cm

T ART. 29741 P ↓ 19 ↔ 18 cm



P ART. 29886 P ↓ 19 ↔ 18 cm

T ART. 29742 P ↓ 19 ↔ 18 cm



P ART. 29887 P ↓ 19 ↔ 18 cm

T ART. 29743 P ↓ 19 ↔ 18 cm



P ART. 29951 P ↓ 19 ↔ 18 cm

T ART. 29748 P ↓ 19 ↔ 18 cm



P ART. 26449 Ø 5 ↓ 19 ↔ 9 cm

T ART. 26056 Ø 5 ↓ 19 ↔ 9 cm



P ART. 26456 Ø 5 ↓ 19 ↔ 9 cm

T ART. 26057 Ø 5 ↓ 19 ↔ 9 cm



P ART. 26452 Ø 5 ↓ 19 ↔ 9 cm

T ART. 26058 Ø 5 ↓ 19 ↔ 9 cm



P ART. 22717 Ø 5 ↓ 19 ↔ 9 cm

T ART. 22117 Ø 5 ↓ 19 ↔ 9 cm



P ART. 26450 Ø 4 ↓ 14 ↔ 7,5 cm

T ART. 26060 Ø 4 ↓ 14 ↔ 7,5 cm



P ART. 26451 Ø 4 ↓ 14 ↔ 7,5 cm

T ART. 26061 Ø 4 ↓ 14 ↔ 7,5 cm



P ART. 26454 Ø 4 ↓ 14 ↔ 7,5 cm

T ART. 26062 Ø 4 ↓ 14 ↔ 7,5 cm



P ART. 22716 Ø 4 ↓ 14 ↔ 7,5 cm

T ART. 22133 Ø 4 ↓ 14 ↔ 7,5 cm



ART. 200140 9x12 cm
ART. 200141 11x15 cm
ART. 200142 13x18 cm



ART. 200146 9x12 cm
ART. 200147 11x15 cm
ART. 200148 13x18 cm



ART. 200152 9x12 cm
ART. 200153 11x15 cm
ART. 200154 13x18 cm



ART. 200127 9x12 cm
ART. 200128 11x15 cm
ART. 200129 13x18 cm



ART. 200143 9x12 cm
ART. 200144 11x15 cm
ART. 200145 13x18 cm



ART. 200149 9x12 cm
ART. 200150 11x15 cm
ART. 200151 13x18 cm



ART. 200155 9x12 cm
ART. 200156 11x15 cm
ART. 200157 13x18 cm



ART. 200130 9x12 cm
ART. 200132 11x15 cm
ART. 200133 13x18 cm

Porcellana smalto bianco con inserti in acciaio inox 18/10



ART. 21200 P
↓ 21 ↔ 12 cm

ART. 21292 P
↓ 14 ↔ 7,5 cm

ART. 21298 P
↓ 12 ↔ 6 cm

ART. 21036 P T
↓ 21 ↔ 12 cm

ART. 21101 P T
↓ 14 ↔ 7,5 cm



ART. 29287 P T
↓ 19 ↔ 16 cm

ART. 29000 P T
↓ 19 ↔ 16 cm



ART. 22200 Ø 5 P T
↓ 20 ↔ 9 cm

ART. 22002 Ø 5 T
↓ 20 ↔ 9 cm

ART. 22295 Ø 4
↓ 14 ↔ 7 cm

ART. 22115 Ø 4 T
↓ 14 ↔ 7 cm



ART. 22200 Ø 5 P T
↓ 20 ↔ 9 cm

ART. 22002 Ø 5 T
↓ 20 ↔ 9 cm

ART. 22295 Ø 4
↓ 14 ↔ 7 cm

ART. 22115 Ø 4 T
↓ 14 ↔ 7 cm

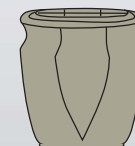

ART. 29287 P T
↓ 19 ↔ 16 cm

ART. 29000 P T
↓ 19 ↔ 16 cm



ART. 21200 P T
↓ 21 ↔ 12 cm

ART. 21036 P T
↓ 21 ↔ 12 cm

ART. 21292 P T
↓ 14 ↔ 7,5 cm

ART. 21101 P T
↓ 14 ↔ 7,5 cm

ART. 21298 P T
↓ 12 ↔ 6 cm



ART. 20618 7x9 cm
ART. 20619 8x10 cm
ART. 20620 9x12 cm
ART. 20621 11x15 cm
ART. 20622 13x18 cm



ART. 20623 7x9 cm
ART. 20624 8x10 cm
ART. 20625 9x12 cm
ART. 20626 10x15 cm
ART. 20627 11x15 cm
ART. 20628 13x18 cm



ART. 24358 10x6 cm
ART. 24359 15x9 cm
ART. 24360 20x11 cm
ART. 24361 30x14 cm
ART. 24362 40x20 cm



ART. 24358 10x6 cm
ART. 24359 15x9 cm
ART. 24360 20x11 cm
ART. 24361 30x14 cm
ART. 24362 40x20 cm



ART. 20623 7x9 cm
ART. 20624 8x10 cm
ART. 20625 9x12 cm
ART. 20626 10x15 cm
ART. 20627 11x15 cm
ART. 20628 13x18 cm



ART. 20618 7x9 cm
ART. 20619 8x10 cm
ART. 20620 9x12 cm
ART. 20621 11x15 cm
ART. 20622 13x18 cm

Porcellana smalto bianco marmorizzata con inserti in acciaio inox 18/10



PORCELLANA

Per ordinazioni aggiungere al codice articolo la sigla corrispondente alla colorazione scelta.
To place orders add to the article code the letter corresponding the selected colouring.

Porcellana smalto bianco con inserti in acciaio inox 18/10

Porcellana smalto bianco marmorizzata con inserti in acciaio inox 18/10



ART. 27330 P $\downarrow 19 \leftrightarrow 10$ cm
 ART. 27117 P $\downarrow 27 \leftrightarrow 16,5$ cm
 ART. 27116 P $\downarrow 20 \leftrightarrow 12$ cm



ART. 29376 P $\downarrow 17,5 \leftrightarrow 17$ cm
 ART. 29145 P $\downarrow 17,5 \leftrightarrow 17$ cm
 ART. 26330 Ø 5 P $\downarrow 20 \leftrightarrow 9,5$ cm
 ART. 26116 Ø 5 T $\downarrow 20 \leftrightarrow 9,5$ cm



ART. 26913 P $\downarrow 17,5 \leftrightarrow 17$ cm
 ART. 26872 T $\downarrow 17,5 \leftrightarrow 11$ cm
 ART. 26873 $\downarrow 21 \leftrightarrow 14$ cm



ART. 20618 7x9 cm
 ART. 20619 8x10 cm
 ART. 20620 9x12 cm
 ART. 20621 11x15 cm
 ART. 20622 13x18 cm



ART. 20623 7x9 cm
 ART. 20624 8x10 cm
 ART. 20625 9x12 cm
 ART. 20626 10x15 cm
 ART. 20627 11x15 cm
 ART. 20628 13x18 cm



ART. 24358 10x6 cm
 ART. 24359 15x9 cm
 ART. 24360 20x11 cm
 ART. 24361 30x14 cm
 ART. 24362 40x20 cm



PORCELLANA



ART. 26330 Ø 5 P $\downarrow 20 \leftrightarrow 9,5$ cm
 ART. 26116 Ø 5 T $\downarrow 20 \leftrightarrow 9,5$ cm

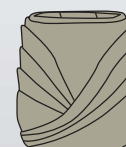

ART. 29376 P $\downarrow 17,5 \leftrightarrow 17$ cm
 ART. 29145 P $\downarrow 17,5 \leftrightarrow 17$ cm



ART. 27330 P $\downarrow 19 \leftrightarrow 10$ cm
 ART. 27117 P $\downarrow 27 \leftrightarrow 16,5$ cm

ART. 27116 P $\downarrow 20 \leftrightarrow 12$ cm



ART. 26913 P $\downarrow 17,5 \leftrightarrow 17$ cm
 ART. 26872 T $\downarrow 17,5 \leftrightarrow 11$ cm
 ART. 26873 $\downarrow 21 \leftrightarrow 14$ cm



ART. 20618 7x9 cm
 ART. 20619 8x10 cm
 ART. 20620 9x12 cm
 ART. 20621 11x15 cm
 ART. 20622 13x18 cm



ART. 20623 7x9 cm
 ART. 20624 8x10 cm
 ART. 20625 9x12 cm
 ART. 20626 10x15 cm
 ART. 20627 11x15 cm
 ART. 20628 13x18 cm



ART. 24358 10x6 cm
 ART. 24359 15x9 cm
 ART. 24360 20x11 cm
 ART. 24361 30x14 cm
 ART. 24362 40x20 cm

Per ordinazioni aggiungere al codice articolo la sigla corrispondente alla colorazione scelta.
 To place orders add to the article code the letter corresponding the selected colouring.

Porcellana smalto bianco con inserti in acciaio inox 18/10



ART. 27285 P
↓ 20 ↔ 12 cm

ART. 27086 P
↓ 29 ↔ 16 cm

ART. 27085 P
↓ 20 ↔ 12 cm



ART. 29203 P
↓ 19 ↔ 17 cm

ART. 29103 P
↓ 19 ↔ 17 cm



ART. 26285 Ø 5
↓ 20 ↔ 8,5 cm

ART. 26085 Ø 5
↓ 20 ↔ 8,5 cm



ART. 26901 P
↓ 17,5 ↔ 11 cm

ART. 26801 T
↓ 17,5 ↔ 11 cm

ART. 26831
↓ 21 ↔ 14 cm



ART. 20618 7x9 cm
ART. 20619 8x10 cm
ART. 20620 9x12 cm
ART. 20621 11x15 cm
ART. 20622 13x18 cm



ART. 20623 7x9 cm
ART. 20624 8x10 cm
ART. 20625 9x12 cm
ART. 20626 10x15 cm
ART. 20627 11x15 cm
ART. 20628 13x18 cm



ART. 24358 10x6 cm
ART. 24359 15x9 cm
ART. 24360 20x11 cm
ART. 24361 30x14 cm
ART. 24362 40x20 cm

Porcellana smalto bianco marmorizzata con inserti in acciaio inox 18/10



PORCELLANA



ART. 26285 Ø 5
↓ 20 ↔ 5,5 cm

ART. 26085 Ø 5
↓ 20 ↔ 8,5 cm



ART. 29203 P
↓ 19 ↔ 17 cm

ART. 29103 P
↓ 19 ↔ 17 cm



ART. 27285 P
↓ 20 ↔ 12 cm

ART. 27086 P
↓ 29 ↔ 16 cm

ART. 27085 P
↓ 20 ↔ 12 cm



ART. 26901 P
↓ 17,5 ↔ 11 cm

ART. 26801 T
↓ 17,5 ↔ 11 cm

ART. 26831
↓ 21 ↔ 14 cm



ART. 20618 7x9 cm
ART. 20619 8x10 cm
ART. 20620 9x12 cm
ART. 20621 11x15 cm
ART. 20622 13x18 cm



ART. 20623 7x9 cm
ART. 20624 8x10 cm
ART. 20625 9x12 cm
ART. 20626 10x15 cm
ART. 20627 11x15 cm
ART. 20628 13x18 cm



ART. 24358 10x6 cm
ART. 24359 15x9 cm
ART. 24360 20x11 cm
ART. 24361 30x14 cm
ART. 24362 40x20 cm

Per ordinazioni aggiungere al codice articolo la sigla corrispondente alla colorazione scelta.
To place orders add to the article code the letter corresponding the selected colouring.

Porcellana smalto bianco con inserti in acciaio inox 18/10



ART. 29335 P P ART. 29128 P T
 ↓ 18 ↔ 17 cm. ↓ 18 ↔ 17 cm.



ART. 26292 Ø 5 P ART. 26092 Ø 5 T
 ↓ 20 ↔ 9 cm. ↓ 20 ↔ 9 cm.



ART. 20618 7x9 cm
 ART. 20619 8x10 cm
 ART. 20620 9x12 cm
 ART. 20621 11x15 cm
 ART. 20622 13x18 cm



ART. 20623 7x9 cm
 ART. 20624 8x10 cm
 ART. 20625 9x12 cm
 ART. 20626 10x15 cm
 ART. 20627 11x15 cm
 ART. 20628 13x18 cm



ART. 24358 10x6 cm
 ART. 24359 15x9 cm
 ART. 24360 20x11 cm
 ART. 24361 30x14 cm
 ART. 24362 40x20 cm

Porcellana smalto bianco marmorizzata con inserti in acciaio inox 18/10



PORCELLANA



ART. 26292 Ø 5 P ART. 26092 Ø 5 T
 ↓ 20 ↔ 5,5 cm. ↓ 20 ↔ 8,5 cm.



ART. 29335 P P ART. 29128 P T
 ↓ 19 ↔ 17 cm. ↓ 19 ↔ 17 cm.



ART. 27291 P P ART. 27091 P T
 ↓ 20 ↔ 12 cm. ↓ 20 ↔ 12 cm.



ART. 20618 7x9 cm
 ART. 20619 8x10 cm
 ART. 20620 9x12 cm
 ART. 20621 11x15 cm
 ART. 20622 13x18 cm

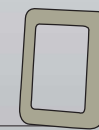

ART. 20623 7x9 cm
 ART. 20624 8x10 cm
 ART. 20625 9x12 cm
 ART. 20626 10x15 cm
 ART. 20627 11x15 cm
 ART. 20628 13x18 cm



ART. 24358 10x6 cm
 ART. 24359 15x9 cm
 ART. 24360 20x11 cm
 ART. 24361 30x14 cm
 ART. 24362 40x20 cm

Per ordinazioni aggiungere al codice articolo la sigla corrispondente alla colorazione scelta.
 To place orders add to the article code the letter corresponding the selected colouring.

Porcellana smalto bianco con inserti in acciaio inox 18/10



ART. 27219 P **P** ART. 27048 P **T**
 ↓ 20 ↔ 12 cm ↓ 20 ↔ 12 cm



ART. 27218 P **P**
 ↓ 13 ↔ 8 cm



ART. 29334 P **P**
 ↓ 17 ↔ 17,5 cm



ART. 26238 Ø 5 **P**
 ↓ 20 ↔ 9,5 cm

ART. 27045 P **T**
 ↓ 13 ↔ 8 cm

ART. 29074 P **T**
 ↓ 17 ↔ 17,5 cm

ART. 26035 Ø 5 **T**
 ↓ 20 ↔ 9,5 cm

Porcellana smalto bianco marmorizzata con inserti in acciaio inox 18/10

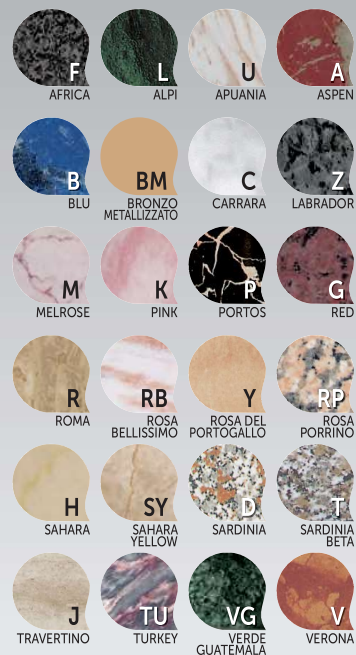

PORCELLANA



ART. 26238 Ø 5 **P**
 ↓ 20 ↔ 9,5 cm

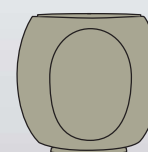

ART. 29334 P **P**
 ↓ 17 ↔ 17,5 cm



ART. 27218 P **P**
 ↓ 13 ↔ 8 cm



ART. 27219 P **P** ART. 27048 P **T**
 ↓ 20 ↔ 12 cm ↓ 20 ↔ 12 cm

ART. 26035 Ø 5 **T**
 ↓ 20 ↔ 9,5 cm

ART. 29074 P **T**
 ↓ 17 ↔ 17,5 cm

ART. 27045 P **T**
 ↓ 13 ↔ 8 cm



ART. 26234 Ø 4 **P**
 ↓ 13 ↔ 7 cm



ART. 20618 7x9 cm
 ART. 20619 8x10 cm
 ART. 20620 9x12 cm
 ART. 20621 11x15 cm
 ART. 20622 13x18 cm



ART. 20623 7x9 cm
 ART. 20624 8x10 cm
 ART. 20625 9x12 cm
 ART. 20626 10x15 cm
 ART. 20627 11x15 cm
 ART. 20628 13x18 cm



ART. 24358 10x6 cm
 ART. 24359 15x9 cm
 ART. 24360 20x11 cm
 ART. 24361 30x14 cm
 ART. 24362 40x20 cm



ART. 26234 Ø 4 **P**
 ↓ 13 ↔ 7 cm



ART. 20618 7x9 cm
 ART. 20619 8x10 cm
 ART. 20620 9x12 cm
 ART. 20621 11x15 cm
 ART. 20622 13x18 cm



ART. 20623 7x9 cm
 ART. 20624 8x10 cm
 ART. 20625 9x12 cm
 ART. 20626 10x15 cm
 ART. 20627 11x15 cm
 ART. 20628 13x18 cm



ART. 24358 10x6 cm
 ART. 24359 15x9 cm
 ART. 24360 20x11 cm
 ART. 24361 30x14 cm
 ART. 24362 40x20 cm

Per ordinazioni aggiungere al codice articolo la sigla corrispondente alla colorazione scelta.
 To place orders add to the article code the letter corresponding the selected colouring.

SERIE **TAORMINA BIANCA**

SERIE **AMALFI BIANCA**

smalto bianco

SERIE **TAORMINA COLOR**

SERIE **AMALFI COLOR**

smalto bianco marmorizzato



ART. 29467 P
↓ 19 ↔ 19 cm

ART. 22467 Ø 5
↓ 21 ↔ 15 cm

ART. 29419 P
↓ 19,5 ↔ 18,5 cm

ART. 26419 Ø 5
↓ 20 ↔ 13,5 cm

ART. 29467 P
↓ 19 ↔ 19 cm

ART. 22467 Ø 5
↓ 21 ↔ 15 cm

ART. 29419 P
↓ 19,5 ↔ 18,5 cm

ART. 26419 Ø 5
↓ 20 ↔ 13,5 cm

ART. 29077 P
↓ 19 ↔ 19 cm

ART. 22067 Ø 5
↓ 21 ↔ 15 cm

ART. 29077 P
↓ 19 ↔ 19 cm

ART. 22067 Ø 5
↓ 21 ↔ 15 cm

SERIE **OSTUNI BIANCA**

smalto bianco

SERIE **ODEON BIANCA**

SERIE **OSTUNI COLOR**

smalto bianco marmorizzato

SERIE **ODEON COLOR**



ART. 29414 P
↓ 20 ↔ 20 cm

ART. 26414 Ø 5
↓ 20 ↔ 16 cm

ART. 29519 P
↓ 19 ↔ 18 cm

ART. 26519 Ø 5
↓ 21 ↔ 13,5 cm

ART. 29414 P
↓ 20 ↔ 20 cm

ART. 26414 Ø 5
↓ 20 ↔ 16 cm

ART. 29519 P
↓ 19 ↔ 18 cm

ART. 26519 Ø 5
↓ 21 ↔ 13,5 cm

ART. 29019 P
↓ 19 ↔ 18 cm

ART. 26119 Ø 5
↓ 21 ↔ 13,5 cm

ART. 29019 P
↓ 19 ↔ 18 cm

ART. 26119 Ø 5
↓ 21 ↔ 13,5 cm

SERIE **ODEON DECOR**



ART. 29562 P
↓ 19 ↔ 18 cm

ART. 29002 T
↓ 19 ↔ 18 cm

ART. 26563 Ø 5
↓ 21 ↔ 13,5 cm

ART. 26003 Ø 5
↓ 21 ↔ 13,5 cm

ART. 29332 P
↓ 16 ↔ 27 cm



Per ordinazioni aggiungere al codice articolo la sigla corrispondente alla colorazione scelta.
To place orders add to the article code the letter corresponding the selected colouring.



| | | | | | | | | | | | |
|-------------------------------|-------------------------------|---------------------------------|-------------------------------|-------------------------------|---------------------------------|-------------------------------|-------------------------------|-----------------------------------|-------------------------------|-------------------------------|-----------------------------------|
| ART. 27476 P ↓ 11 ↔ 7 cm | ART. 27579 P T ↓ 13 ↔ 8 cm | ART. 26616 Ø 4 P ↓ 13 ↔ 7 cm | ART. 27482 P ↓ 11 ↔ 7 cm | ART. 27583 P T ↓ 13 ↔ 8 cm | ART. 26617 Ø 4 P ↓ 13 ↔ 7 cm | ART. 27475 P ↓ 11 ↔ 7 cm | ART. 27565 P T ↓ 13 ↔ 8 cm | ART. 26601 Ø 4 P ↓ 13 ↔ 7,5 cm | ART. 27477 P ↓ 11 ↔ 7 cm | ART. 27569 P T ↓ 13 ↔ 8 cm | ART. 26603 Ø 4 P ↓ 13 ↔ 7,5 cm |
| ART. 27624 P ↓ 13 ↔ 8 cm | ART. 27578 R/C ↓ 13 ↔ 8 cm | ART. 26150 Ø 4 T ↓ 13 ↔ 7 cm | ART. 27626 P ↓ 13 ↔ 8 cm | ART. 27582 R/C ↓ 13 ↔ 8 cm | ART. 26153 Ø 4 T ↓ 13 ↔ 7 cm | ART. 27607 P ↓ 13 ↔ 8 cm | ART. 27564 R/C ↓ 13 ↔ 8 cm | ART. 26144 Ø 4 T ↓ 13 ↔ 7,5 cm | ART. 27612 P ↓ 13 ↔ 8 cm | ART. 27568 R/C ↓ 13 ↔ 8 cm | ART. 26145 Ø 4 T ↓ 13 ↔ 7,5 cm |
| ART. 27623 R/C ↓ 13 ↔ 8 cm | | | ART. 27625 R/C ↓ 13 ↔ 8 cm | | | ART. 27606 R/C ↓ 13 ↔ 8 cm | | | ART. 27609 R/C ↓ 13 ↔ 8 cm | | |



| | | | | | | | | | | | |
|-------------------------------|-------------------------------|---------------------------------|-------------------------------|-------------------------------|---------------------------------|-------------------------------|-------------------------------|-----------------------------------|-------------------------------|-------------------------------|-----------------------------------|
| ART. 27483 P ↓ 11 ↔ 7 cm | ART. 27585 P T ↓ 13 ↔ 8 cm | ART. 26618 Ø 4 P ↓ 13 ↔ 7 cm | ART. 27484 P ↓ 11 ↔ 7 cm | ART. 27587 P T ↓ 13 ↔ 8 cm | ART. 26619 Ø 4 P ↓ 13 ↔ 7 cm | ART. 27480 P ↓ 11 ↔ 7 cm | ART. 27575 P T ↓ 13 ↔ 8 cm | ART. 26613 Ø 4 P ↓ 13 ↔ 7,5 cm | ART. 27481 P ↓ 11 ↔ 7 cm | ART. 27577 P T ↓ 13 ↔ 8 cm | ART. 26614 Ø 4 P ↓ 13 ↔ 7,5 cm |
| ART. 27628 P ↓ 13 ↔ 8 cm | ART. 27584 R/C ↓ 13 ↔ 8 cm | ART. 26180 Ø 4 T ↓ 13 ↔ 7 cm | ART. 27630 P ↓ 13 ↔ 8 cm | ART. 27586 R/C ↓ 13 ↔ 8 cm | ART. 26182 Ø 4 T ↓ 13 ↔ 7 cm | ART. 27620 P ↓ 13 ↔ 8 cm | ART. 27574 R/C ↓ 13 ↔ 8 cm | ART. 26148 Ø 4 T ↓ 13 ↔ 7,5 cm | ART. 27622 P ↓ 13 ↔ 8 cm | ART. 27576 R/C ↓ 13 ↔ 8 cm | ART. 26149 Ø 4 T ↓ 13 ↔ 7,5 cm |
| ART. 27627 R/C ↓ 13 ↔ 8 cm | | | ART. 27629 R/C ↓ 13 ↔ 8 cm | | | ART. 27619 R/C ↓ 13 ↔ 8 cm | | | ART. 27621 R/C ↓ 13 ↔ 8 cm | | |

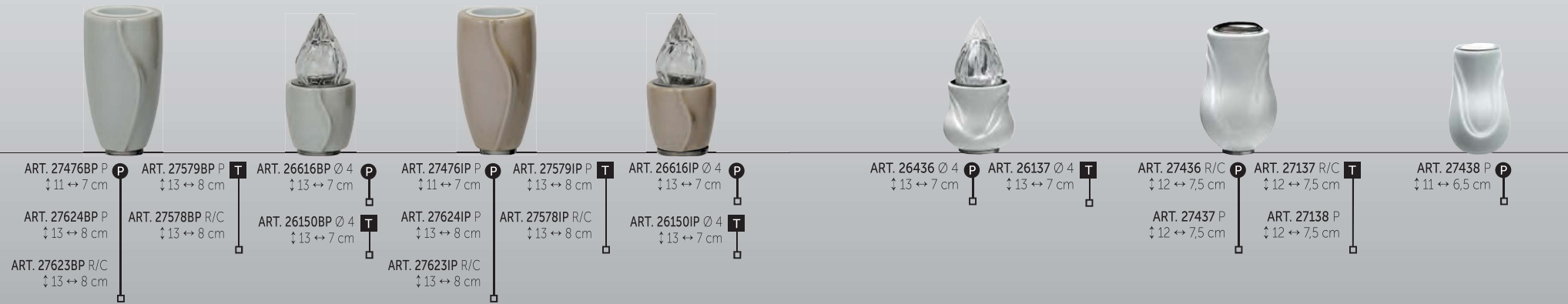

| | | | | | | | | | | |
|---------------------------------|---------------------------------|-----------------------------------|---------------------------------|---------------------------------|-----------------------------------|---------------------------------|---------------------------------|-----------------------------------|-----------------------------------|-------------------------------|
| ART. 27476BP P ↓ 11 ↔ 7 cm | ART. 27579BP T ↓ 13 ↔ 8 cm | ART. 26616BP Ø 4 P ↓ 13 ↔ 7 cm | ART. 27476IP P ↓ 11 ↔ 7 cm | ART. 27579IP T ↓ 13 ↔ 8 cm | ART. 26616IP Ø 4 P ↓ 13 ↔ 7 cm | ART. 26436 Ø 4 P ↓ 13 ↔ 7 cm | ART. 26137 Ø 4 T ↓ 13 ↔ 7 cm | ART. 27436 R/C P ↓ 12 ↔ 7,5 cm | ART. 27137 R/C T ↓ 12 ↔ 7,5 cm | ART. 27438 P ↓ 11 ↔ 6,5 cm |
| ART. 27624BP P ↓ 13 ↔ 8 cm | ART. 27578BP R/C ↓ 13 ↔ 8 cm | ART. 26150BP Ø 4 T ↓ 13 ↔ 7 cm | ART. 27624IP P ↓ 13 ↔ 8 cm | ART. 27578IP R/C ↓ 13 ↔ 8 cm | ART. 26150IP Ø 4 T ↓ 13 ↔ 7 cm | | | ART. 27437 P ↓ 12 ↔ 7,5 cm | ART. 27138 P ↓ 12 ↔ 7,5 cm | |
| ART. 27623BP R/C ↓ 13 ↔ 8 cm | | | ART. 27623IP R/C ↓ 13 ↔ 8 cm | | | | | | | |

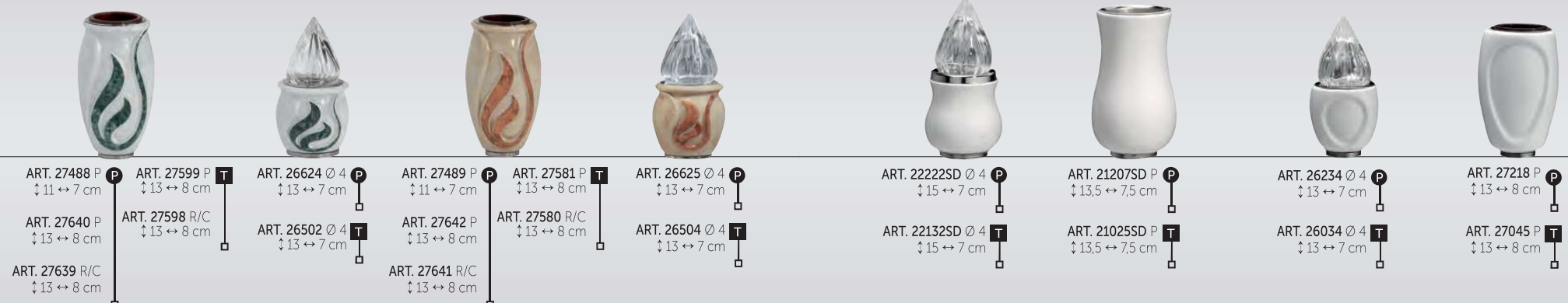



SMALTO
BIANCO



SMALTO
BIANCO



ART. 21297 P **P**
↓ 14 ↔ 8 cm

ART. 21299 P
↓ 12 ↔ 6,5 cm

ART. 21111 P **T**
↓ 14 ↔ 8 cm

ART. 22297 Ø 4 **P**
↓ 14 ↔ 7,5 cm

ART. 22110 Ø 4 **T**
↓ 14 ↔ 7,5 cm

ART. 27676 P **P**
↓ 12 ↔ 6,5 cm

ART. 27675 P
↓ 14 ↔ 8 cm

ART. 27723 P **T**
↓ 14 ↔ 8 cm

ART. 26450 Ø 4 **P**
↓ 14 ↔ 7,5 cm

ART. 26060 Ø 4 **T**
↓ 14 ↔ 7,5 cm

ART. 22359SD Ø 4 **P**
↓ 14 ↔ 8 cm.

ART. 22159SD Ø 4 **T**
↓ 14 ↔ 8 cm.

ART. 21359SD R/C **P**
↓ 15 ↔ 10 cm.

ART. 21159SD R/C **T**
↓ 15 ↔ 10 cm.

ART. 21371SD P **P**
↓ 11 ↔ 6 cm.

ART. 21258 P **P**
↓ 14 ↔ 8 cm.

ART. 21259 R/C
↓ 14 ↔ 8 cm.

ART. 21518 P **T**
↓ 14 ↔ 8 cm.

ART. 21519 R/C
↓ 14 ↔ 8 cm.

ART. 22258 Ø 4 **P**
↓ 14 ↔ 8 cm.

ART. 22518 Ø 4 **T**
↓ 14 ↔ 8 cm.



SMALTO
BIANCO



ART. 27679 P **P**
↓ 12 ↔ 6,5 cm

ART. 27678 P
↓ 14 ↔ 8 cm

ART. 27725 P **T**
↓ 14 ↔ 8 cm

ART. 26451 Ø 4 **P**
↓ 14 ↔ 7,5 cm

ART. 26061 Ø 4 **T**
↓ 14 ↔ 7,5 cm

ART. 27682 P **P**
↓ 12 ↔ 6,5 cm

ART. 27681 P
↓ 14 ↔ 8 cm

ART. 27727 P **T**
↓ 14 ↔ 8 cm

ART. 26454 Ø 4 **P**
↓ 14 ↔ 7,5 cm

ART. 26062 Ø 4 **T**
↓ 14 ↔ 7,5 cm

ART. 22243 Ø 4 **P**
↓ 14 ↔ 8 cm

ART. 22418 Ø 4 **T**
↓ 14 ↔ 8 cm

ART. 21414 R **T**
↓ 15 ↔ 9 cm

ART. 21417 P
↓ 15 ↔ 9 cm

ART. 21246 R **P**
↓ 15 ↔ 9 cm

ART. 21243 P
↓ 15 ↔ 9 cm

ART. 21462 P
↓ 12 ↔ 5,5 cm

ART. 22249 Ø 4 **P**
↓ 12 ↔ 7,5 cm

ART. 21249 P **P**
↓ 13 ↔ 7,5 cm



ART. 21793 P **P**
↓ 12 ↔ 6,5 cm

ART. 21792 P
↓ 14 ↔ 8 cm

ART. 21192 P **T**
↓ 14 ↔ 8 cm

ART. 22716 Ø 4 **P**
↓ 14 ↔ 7,5 cm

ART. 22133 Ø 4 **T**
↓ 14 ↔ 7,5 cm

ART. 21297BP P **P**
↓ 14 ↔ 8 cm

ART. 21299BP P
↓ 12 ↔ 6,5 cm

ART. 21111BP P **T**
↓ 14 ↔ 8 cm

ART. 22297BP Ø 4 **P**
↓ 14 ↔ 7,5 cm

ART. 22110BP Ø 4 **T**
↓ 14 ↔ 7,5 cm

ART. 21297IP P **P**
↓ 14 ↔ 8 cm

ART. 21299IP P
↓ 12 ↔ 6,5 cm

ART. 21111IP P **T**
↓ 14 ↔ 8 cm

ART. 22297IP Ø 4 **P**
↓ 14 ↔ 7,5 cm

ART. 22110IP Ø 4 **T**
↓ 14 ↔ 7,5 cm

ART. 21202 P **P**
↓ 11 ↔ 4,5 cm

ART. 22347 Ø 4 **P**
↓ 12 ↔ 7,5 cm

ART. 21328 P **P**
↓ 11 ↔ 5 cm



ART. 22268SD Ø 4 P
↓ 13 ↔ 7 cm



ART. 21268SD R P
↓ 13 ↔ 7 cm



ART. 21233SD P P
↓ 11 ↔ 7 cm



ART. 22268 Ø 4 P
↓ 13 ↔ 7 cm



ART. 21268 R P
↓ 13 ↔ 7 cm



ART. 21233 P P
↓ 11 ↔ 7 cm



ART. 22319SD Ø 4 P
↓ 12 ↔ 7 cm



ART. 21318SD P P
↓ 13 ↔ 7 cm



ART. 21190SD P P
↓ 11 ↔ 6 cm



ART. 22319 Ø 4 P
↓ 12 ↔ 7 cm



ART. 21318 P P
↓ 13 ↔ 7 cm



ART. 21190 P P
↓ 11 ↔ 6 cm

ART. 22068SD Ø 4 T
↓ 13 ↔ 7 cm

ART. 21068SD R T
↓ 13 ↔ 7 cm

ART. 21067SD P T
↓ 11 ↔ 7 cm

ART. 22068 Ø 4 T
↓ 13 ↔ 7 cm

ART. 21068 R T
↓ 13 ↔ 7 cm

ART. 21067 P T
↓ 11 ↔ 7 cm

ART. 22119SD Ø 4 T
↓ 12 ↔ 7 cm

ART. 21119SD P T
↓ 13 ↔ 7 cm

ART. 22119 Ø 4 T
↓ 12 ↔ 7 cm

ART. 21119 P T
↓ 13 ↔ 7 cm



ART. 22309 Ø 4 P
↓ 13 ↔ 7 cm



ART. 21324 R P
↓ 13 ↔ 7 cm



ART. 22301 Ø 4 P
↓ 13 ↔ 7 cm



ART. 21308 R P
↓ 13 ↔ 7 cm



PR. LEGA BRONZO
ART. 0152 Ø 4 P
↓ 14 ↔ 7 cm.

PR. LEGA BRONZO
ART. 0114 Ø 4 T
↓ 14 ↔ 7 cm.



PR. LEGA BRONZO
ART. 0054 R P
↓ 14 ↔ 8 cm.

PR. LEGA BRONZO
ART. 0027 R T
↓ 14 ↔ 8 cm.



PR. LEGA BRONZO
ART. 0058 R/C P
↓ 11 ↔ 6 cm.

PR. LEGA BRONZO
ART. 0031 Ø 5 T
↓ 11 ↔ 6 cm.

ART. 22009 Ø 4 T
↓ 13 ↔ 7 cm

ART. 21023 R T
↓ 13 ↔ 7 cm

ART. 22041 Ø 4 T
↓ 13 ↔ 7 cm

ART. 21018 R T
↓ 13 ↔ 7 cm

ART. 0055 P
↓ 14 ↔ 8 cm.

ART. 0028 P
↓ 14 ↔ 8 cm.



ART. 22278 Ø 4 P
↓ 15 ↔ 7 cm



ART. 21278 P P
↓ 13,5 ↔ 7,5 cm

ART. 22078 Ø 4 T
↓ 15 ↔ 7 cm

ART. 21079 P T
↓ 13,5 ↔ 7,5 cm



INOX
ART. 0153 Ø 4 P
↓ 14 ↔ 7 cm

INOX
ART. 0115 Ø 4 T
↓ 14 ↔ 7 cm



INOX
ART. 0056 R/C P
↓ 14 ↔ 8 cm

INOX
ART. 0029 R/C T
↓ 14 ↔ 8 cm



INOX
ART. 0063 P P
↓ 11 ↔ 6 cm

INOX
ART. 0036 Ø 5 T
↓ 11 ↔ 6 cm



ART. 20665 9x12 cm
ART. 20666 11x15 cm
ART. 20667 13x18 cm

COLOR

ART. 20665 9x12 cm
ART. 20666 11x15 cm
ART. 20667 13x18 cm



ART. 20668 9x12 cm
ART. 20669 10x15 cm
ART. 20670 11x15 cm
ART. 20671 13x18 cm

COLOR

ART. 20668 9x12 cm
ART. 20669 10x15 cm
ART. 20670 11x15 cm
ART. 20671 13x18 cm



ART. 20906 9x12 cm
ART. 20907 11x15 cm
ART. 20908 13x18 cm

COLOR

ART. 20906 9x12 cm
ART. 20907 11x15 cm
ART. 20908 13x18 cm



ART. 20916 9x12 cm
ART. 20917 10x15 cm
ART. 20918 11x15 cm
ART. 20919 13x18 cm

COLOR

ART. 20916 9x12 cm
ART. 20917 10x15 cm
ART. 20918 11x15 cm
ART. 20919 13x18 cm



SMALTO
BIANCO

ART. 20618 7x9 cm
ART. 20619 8x10 cm
ART. 20620 9x12 cm
ART. 20621 11x15 cm
ART. 20622 13x18 cm

COLOR

ART. 20618 7x9 cm
ART. 20619 8x10 cm
ART. 20620 9x12 cm
ART. 20621 11x15 cm
ART. 20622 13x18 cm



ART. 20623 7x9 cm
ART. 20624 8x10 cm
ART. 20625 9x12 cm
ART. 20626 10x15 cm
ART. 20627 11x15 cm
ART. 20628 13x18 cm

COLOR

ART. 20623 7x9 cm
ART. 20624 8x10 cm
ART. 20625 9x12 cm
ART. 20626 10x15 cm
ART. 20627 11x15 cm
ART. 20628 13x18 cm



NOVITÀ

SMALTO
BIANCO
FILETTO
PICCOLO

ART. 200158 9x12 cm
ART. 200159 11x15 cm
ART. 200160 13x18 cm

COLOR
ART. 200158 9x12 cm
ART. 200159 11x15 cm
ART. 200160 13x18 cm



ART. 200161 9x12 cm
ART. 200162 11x15 cm
ART. 200163 13x18 cm

COLOR
ART. 200161 9x12 cm
ART. 200162 11x15 cm
ART. 200163 13x18 cm



ART. 20158 7x9 cm
ART. 20159 8x10 cm
ART. 20155 9x12 cm
ART. 20156 11x15 cm
ART. 20157 13x18 cm

COLOR

ART. 20158 7x9 cm
ART. 20159 8x10 cm
ART. 20155 9x12 cm
ART. 20156 11x15 cm
ART. 20157 13x18 cm



ART. 20166 9x12 cm
ART. 20167 10x15 cm
ART. 20168 11x15 cm
ART. 20169 13x18 cm

COLOR

ART. 20166 9x12 cm
ART. 20167 10x15 cm
ART. 20168 11x15 cm
ART. 20169 13x18 cm



ART. 20153 7x9 cm
ART. 20154 8x10 cm
ART. 20263 9x12 cm
ART. 20264 11x15 cm
ART. 20265 13x18 cm

COLOR

ART. 20153 7x9 cm
ART. 20154 8x10 cm
ART. 20263 9x12 cm
ART. 20264 11x15 cm
ART. 20265 13x18 cm



ART. 20323 7x9 cm
ART. 20324 8x10 cm
ART. 20345 9x12 cm
ART. 20346 10x15 cm
ART. 20347 11x15 cm
ART. 20348 13x18 cm

COLOR

ART. 20323 7x9 cm
ART. 20324 8x10 cm
ART. 20345 9x12 cm
ART. 20346 10x15 cm
ART. 20347 11x15 cm
ART. 20348 13x18 cm



SMALTO
BIANCO

ART. 200134 9x12 cm
ART. 200135 11x15 cm
ART. 200136 13x18 cm

COLOR

ART. 200134 9x12 cm
ART. 200135 11x15 cm
ART. 200136 13x18 cm



ART. 200137 9x12 cm
ART. 200138 11x15 cm
ART. 200139 13x18 cm

COLOR

ART. 200137 9x12 cm
ART. 200138 11x15 cm
ART. 200139 13x18 cm



IVORY

ART. 200127 9x12 cm
ART. 200128 11x15 cm
ART. 200129 13x18 cm



ART. 200130 9x12 cm
ART. 200132 11x15 cm
ART. 200133 13x18 cm



ART. 20386 9x12 cm
ART. 20387 11x15 cm

COLOR

ART. 20386 9x12 cm
ART. 20387 11x15 cm



ART. 20113 9x12 cm
ART. 20114 11x15 cm
ART. 20115 13x18 cm

COLOR

ART. 20113 9x12 cm
ART. 20114 11x15 cm
ART. 20115 13x18 cm



ART. 20099 Ø 10 cm

COLOR

ART. 20099 Ø 10 cm



Per ordinazioni aggiungere al codice articolo la sigla corrispondente alla colorazione scelta.
To place orders add to the article code the letter corresponding the selected colouring.

Per ordinazioni aggiungere al codice articolo la sigla corrispondente alla colorazione scelta.
To place orders add to the article code the letter corresponding the selected colouring.



ART. 20898 9x12 cm
ART. 20899 11x15 cm
ART. 20900 13x18 cm

COLOR

ART. 20898 9x12 cm
ART. 20899 11x15 cm
ART. 20900 13x18 cm



ART. 20901 9x12 cm
ART. 20902 10x15 cm
ART. 20909 11x15 cm
ART. 20910 13x18 cm

COLOR

ART. 20901 9x12 cm
ART. 20902 10x15 cm
ART. 20909 11x15 cm
ART. 20910 13x18 cm



Portaritratto inox con pergamena e cornice
ART. 20390
Preventivo a richiesta
Estimate on request



ART. 24025 ↓10 ↔ 6 cm
ART. 24026 ↓15 ↔ 9 cm
ART. 24027 ↓20 ↔ 11 cm
ART. 24028 ↓30 ↔ 14 cm
ART. 24029 ↓40 ↔ 20 cm

COLOR

ART. 24025 ↓10 ↔ 6 cm
ART. 24026 ↓15 ↔ 9 cm
ART. 24027 ↓20 ↔ 11 cm
ART. 24028 ↓30 ↔ 14 cm
ART. 24029 ↓40 ↔ 20 cm



ART. 24195 ↓10 ↔ 6 cm
ART. 24196 ↓15 ↔ 9 cm
ART. 24197 ↓20 ↔ 11 cm
ART. 24198 ↓30 ↔ 14 cm
ART. 24199 ↓40 ↔ 20 cm

COLOR

ART. 24195 ↓10 ↔ 6 cm
ART. 24196 ↓15 ↔ 9 cm
ART. 24197 ↓20 ↔ 11 cm
ART. 24198 ↓30 ↔ 14 cm
ART. 24199 ↓40 ↔ 20 cm



SMALTO
BIANCO

ART. 24358 10x6 cm
ART. 24359 15x9 cm
ART. 24360 20x11 cm
ART. 24361 30x14 cm
ART. 24362 40x20 cm

COLOR

ART. 24358 10x6 cm
ART. 24359 15x9 cm
ART. 24360 20x11 cm
ART. 24361 30x14 cm
ART. 24362 40x20 cm



ART. 24322 20x11 cm

COLOR

ART. 24322 20x11 cm



Per ordinazioni aggiungere al codice articolo la sigla corrispondente alla colorazione scelta.
To place orders add to the article code the letter corresponding the selected colouring.

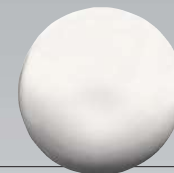

* ART. 23000 Ø 4
* ART. 23001 Ø 5

COLOR

* ART. 23000 Ø 4
* ART. 23001 Ø 5



* ART. 23002 Ø 4
* ART. 23003 Ø 5

COLOR

* ART. 23002 Ø 4
* ART. 23003 Ø 5



ART. 23010 4x4 cm bianca

COLOR

ART. 23010 4x4 cm bianca



ART. 22003 Ø 5
↓3,5 ↔ 7 cm

* I prezzi delle borchie si intendono senza perni e sono predisposte di serie per il perno di Ø 5 MA - ART. 91150

Le borchie sopra rappresentate possono essere richieste nelle colorazioni marmi e graniti.
Per ordinazioni aggiungere al codice articolo la lettera corrispondente alla colorazione scelta.

These studs can be requested in the colours of marble and granites.

To place orders add to the article code the letter corresponding the selected colouring.

Staffe regolabili in primaria lega

con smaltatura bianca portanti per marmo cm 1-2



ART. 30930BI



ART. 30931BI



ART. 30932BI

Perno di Ø 10 MA x 100 compreso nel prezzo



ART. 29014 R
↓ 16 ↔ 22 cm

ART. 29005 R
↓ 17 ↔ 31 cm



ART. 29023 R
↓ 14 ↔ 27,5 cm



ART. 29024 R
↓ 14 ↔ 27,5 cm



ART. 29782
senza interno
↓ 11 ↔ 19 cm

ART. 29783
senza interno
↓ 7 ↔ 13 cm

ART. 29780 P
interno alluminio
↓ 14,5 ↔ 18 cm



ART. 29251SD R
↓ 16 ↔ 17 cm

ART. 29252SD R
↓ 18 ↔ 19 cm



ART. 29781 P
int. alluminio
↓ 14,5 ↔ 19 cm

Per possibili varianti, vedi serie corrispondenti. / For possible changes, see the corresponding series.

INCASSI



ART. 21450 I
↓ 6,5 ↔ 20 cm

ART. 21451 P
↓ 6,5 ↔ 20 cm



ART. 22451 Ø 5
↓ 6,5 ↔ 15 cm



ART. 21116 I
↓ 6 ↔ 18 cm



ART. 22116 Ø 5
↓ 16 ↔ 12 cm

A richiesta:
- con decoro
- colorazioni marmi e graniti



ART. 21002 I
↓ 13 ↔ 20 cm



ART. 21458 I
↓ 5 ↔ 17 cm

ART. 21459 P
↓ 5 ↔ 17 cm



ART. 22458 Ø 5
↓ 14 ↔ 9,5 cm

PORCELLANA

LAMPADE DA APPENDERE



ART. 22292 Ø 8
↓ 90 ↔ 25 cm

ART. 22304 Ø 8
↓ 90 ↔ 25 cm

ART. 22290 Ø 8
↓ 90 ↔ 25 cm

ART. 22302 Ø 8
↓ 90 ↔ 30 cm

ART. 22294 Ø 6
↓ 53 ↔ 21 cm

Targhe fino a h. cm 30 - COLOR PARZIALE (bordo) + 40% - COLOR TOTALE + 100%
Targhe oltre h. cm 30 - SOLO COLOR PARZIALE (Bordo) + 40%



ART. 25194
↓ 13 ↔ 9 cm



ART. 25008
↓ 13 ↔ 10 cm
ART. 25004
↓ 15 ↔ 11 cm



ART. 25235
↓ 16 ↔ 10 cm



ART. 25220
↓ 17 ↔ 9,5 cm



ART. 25044
↓ 21 ↔ 21 cm



ART. 25000
↓ 23 ↔ 15 cm



ART. 25221
↓ 25 ↔ 14,5 cm



ART. 25291
↓ 27 ↔ 22 cm



ART. 25216
↓ 19,5 ↔ 12,5 cm



ART. 25297
↓ 16 ↔ 11,5 cm



ART. 25028
↓ 16 ↔ 16 cm



ART. 25010
↓ 16 ↔ 16 cm



ART. 25018
↓ 20 ↔ 16 cm
ART. 25024
↓ 28 ↔ 26 cm



ART. 25045
↓ 29 ↔ 15,5 cm



ART. 25186
↓ 30 ↔ 20 cm



ART. 25297
↓ 16 ↔ 11,5 cm



Foto a titolo d'esempio

Per ordinazioni aggiungere al codice articolo la sigla corrispondente alla colorazione scelta.
To place orders add to the article code the letter corresponding the selected colouring.



ART. 25022
↓ 37 ↔ 18 cm



ART. 25021
↓ 40 ↔ 16 cm



ART. 25111
↓ 40 ↔ 19 cm



ART. 25038
↓ 49 ↔ 15 cm

PORCELLANA

Targhe fino a h. cm 30 - COLOR PARZIALE (bordo) + 40% - COLOR TOTALE + 100%
Targhe oltre h. cm 30 - SOLO COLOR PARZIALE (Bordo) + 40%



ART. 25219
↓ 13 ↔ 9 cm



ART. 25007
↓ 13 ↔ 9 cm
ART. 25003
↓ 15 ↔ 11 cm



ART. 25234
↓ 16 ↔ 11 cm



ART. 25231
↓ 16,5 ↔ 9 cm



ART. 25017
↓ 20 ↔ 16 cm



ART. 25001
↓ 23 ↔ 15 cm



ART. 25230
↓ 25 ↔ 14 cm



ART. 25296
↓ 16 ↔ 11,5 cm



ART. 25027
↓ 16 ↔ 16 cm



ART. 25012
↓ 16 ↔ 16 cm



ART. 25043
↓ 26 ↔ 21 cm



ART. 25200
↓ 26 ↔ 18 cm



ART. 25290
↓ 27 ↔ 20 cm



ART. 25296
↓ 16 ↔ 11,5 cm



ART. 25046
↓ 27 ↔ 26 cm



ART. 25023
↓ 28 ↔ 26 cm



ART. 25201
↓ 34 ↔ 24 cm

PORCELLANA

Foto a titolo d'esempio

Per ordinazioni aggiungere al codice articolo la sigla corrispondente alla colorazione scelta.
To place orders add to the article code the letter corresponding the selected colouring.



ART. 25037
↓ 36 ↔ 24,5 cm



ART. 25183
↓ 37 ↔ 12 cm



ART. 25202
↓ 48 ↔ 36 cm



ART. 25180
↓ 85 ↔ 56 cm



ART. 25039
↓ 49 ↔ 15 cm



ART. 25006
↓ 14 ↔ 15 cm
ART. 25002
↓ 23 ↔ 24 cm



ART. 25005
↓ 17 ↔ 15 cm



ART. 25233
↓ 19 ↔ 10 cm



ART. 25232
↓ 25 ↔ 16 cm



ART. 25184
↓ 27 ↔ 30 cm
ART. 25185
↓ 32 ↔ 34 cm



ART. 25218
↓ 18 ↔ 17 cm



ART. 25298
↓ 17 ↔ 17 cm

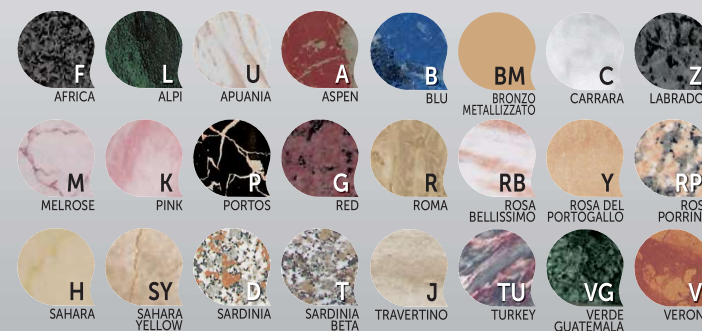

ART. 25298
↓ 17 ↔ 17 cm

PORCELLANA

Foto a titolo d'esempio

Per ordinazioni aggiungere al codice articolo la sigla corrispondente alla colorazione scelta.
To place orders add to the article code the letter corresponding the selected colouring.



ART. 25049
 ↓ 31 ↔ 50 cm



ART. 25108
 ↓ 45 ↔ 32 cm



ART. 25030
 ↓ 47 ↔ 42 cm



ART. 25176
 ↓ 37 ↔ 20 cm



ART. 25182
 ↓ 37 ↔ 12 cm



ART. 25040
 ↓ 49 ↔ 15 cm



ART. 25025
 ↓ 49 ↔ 16 cm



ART. 25173
 ↓ 6,5 ↔ 14 cm
 ART. 25174
 ↓ 8 ↔ 16 cm



ART. 25034
 ↓ 11 ↔ 20 cm



ART. 25247
 ↓ 12 ↔ 6 cm



ART. 25248
 ↓ 12 ↔ 6 cm



ART. 25240
 ↓ 12 ↔ 14 cm



ART. 25241
 ↓ 12 ↔ 14 cm



ART. 25175
 ↓ 13 ↔ 13 cm



Angelo con Cornice sinistro
 ART. 25019
 ↓ 9 ↔ 12 cm



Angelo con Cornice destro
 ART. 25036
 ↓ 9 ↔ 12 cm



ART. 25295
↓ 9,5 ↔ 11 cm



ART. 25191
↓ 13 ↔ 10 cm



ART. 25192
↓ 23 ↔ 11 cm



ART. 25035
↓ 34 ↔ 10 cm



ART. 25278
↓ 15 ↔ 11 cm



ART. 25279
↓ 15 ↔ 13,5 cm



ART. 25280
↓ 15 ↔ 11 cm



ART. 25170
↓ 7,5 ↔ 5 cm
ART. 25171
↓ 9 ↔ 6,5 cm
ART. 25172
↓ 12 ↔ 9 cm



ART. 25238
↓ 20 ↔ 12 cm



ART. 25193
↓ 21 ↔ 12 cm



ART. 25239
↓ 28 ↔ 21 cm



ART. 25178
↓ 30 ↔ 20 cm



ART. 25530 Ø 4 cm
ART. 25531 Ø 6 cm
ART. 25532 Ø 10 cm
ART. 25533 Ø 15 cm
ART. 25534 Ø 20 cm
ART. 25535 Ø 25 cm



Med. Padre Pio
ART. 25269
Ø 15 cm



Med. Padre Pio
ART. 25209
Ø 14,5 cm



Med. Padre Pio
ART. 25268
Ø 8 cm



Med. San Francesco da Paola
ART. 25203
↓ 18 ↔ 13 cm



Busto
ART. 25050
↓ 20 ↔ 13 cm



ART. 28020
↓ 21 ↔ 10 cm



ART. 28003
↓ 25 ↔ 8 cm



ART. 28005
↓ 60 ↔ 25 cm

Madonna di Fatima
ART. 28007
↓ 68 ↔ 23 cm



Busto
ART. 25199
↓ 34 ↔ 28 cm



ART. 28004
↓ 43 ↔ 14 cm



ART. 28008
↓ 52 ↔ 12 cm



Madonna del Carmine
ART. 28026
↓ 80 ↔ 24 cm



Madonna di Lourdes
ART. 28035
↓ 83 ↔ 24 cm



ART. 28019
↓ 21 ↔ 10 cm



ART. 28000
↓ 25 ↔ 8 cm



Statua
ART. 28032
↓ 18 ↔ 15 cm



base 10x10
ART. 28023
↓ 26 ↔ 16,5 cm



ART. 28012
↓ 20 ↔ 14 cm



ART. 28001
↓ 43 ↔ 14 cm



ART. 28002
↓ 60 ↔ 25 cm



ART. 28011
↓ 80 ↔ 35 ↔ 26 cm



ART. 28006
↓ 37 ↔ 15 cm



S. Antonio
ART. 28013
↓ 41 ↔ 12 cm



Pietà di Michelangelo
ART. 28009
↓ 58 ↔ 45 ↔ 29 cm



Padre Pio **T**
ART. 28016
↑ 25 ↔ 8,5 cm



Padre Pio **P**
ART. 28116
↑ 25 ↔ 8,5 cm



Padre Pio
ART. 28029
↑ 35 ↔ 12 ↔ 10 cm



Padre Pio **T**
ART. 28015
↑ 53 ↔ 19 cm

STATUE E TARGHE

decorate a mano su richiesta

Preziose sculture policrome, con decori realizzati a mano dai nostri maestri decoratori. La Vezzani SPA propone le targhe, i medaglioni e le statue in porcellana policroma, **su richiesta a preventivo.**

Fine polychrome sculptures, with hand painted embellishments, created by our master decorators. Vezzani spa propose plates, photograph frames and statues in polychrome porcelain on request with estimate.



PORCELLANA

COLORAZIONE IVORY



Tutti i nostri prodotti in porcellana bianca, possono essere richiesti nella colorazione IVORY.



Eternity



A B C D E F G H
 I J K L M N O P
 Q R S T U V W
 X Y Z

a b c d e f g h i
 j k l m n o p q r
 s t u v w x y z
 1 2 3 4 5 6 7 8 9 0 † ☆ ▲ ○

PORCELLANA

Eternity
 Eternity

SMALTO BIANCO

ART. 5958 Lettere/Numeri ↓ mm 20 spessore mm 7

ART. 5959 Lettere/Numeri ↓ mm 25 spessore mm 7

ART. 5962 Lettere/Numeri ↓ mm 30 spessore mm 7

ART. 5963 Lettere/Numeri ↓ mm 40 spessore mm 7

- È possibile richiedere il carattere Eternity solo nelle misure sopra riportate.
 - Non sono disponibili lettere e numeri sciolti.
 - Le date sono da intendersi su barretta/appoggiate.
 - Negli ordini citare sempre l'altezza delle lettere minuscole a corpo semplice (a-c-m-etc...)
 - Le lettere maiuscole hanno un'altezza superiore alle lettere minuscole del 140% circa e vengono conteggiate allo stesso prezzo delle lettere minuscole.
 - L'altezza delle date è da intendersi asta compresa.
 - Non è possibile richiederlo compresso o allungato.
-
- It is possible to ask for the font Eternity only in these size.
 - Non available loose letters and numbers.
 - Dates are to be meant only on underscore.
 - In the orders always indicate the height of the lower-case letters in simple type size (a-c-m-, etc...)
 - The upper-case letters are higher by about 140% than the lower-case letters, and are counted in the same way as the lower-case letters.
 - The height of the dates are always indicated number included underscore.
 - It's not possible request it compressed or expanded.



F
AFRICA
ART. 5958F ↓ mm 20
ART. 5959F ↓ mm 25
ART. 5962F ↓ mm 30
ART. 5963F ↓ mm 40



L
ALPI
ART. 5958L ↓ mm 20
ART. 5959L ↓ mm 25
ART. 5962L ↓ mm 30
ART. 5963L ↓ mm 40



U
APUANIA
ART. 5958U ↓ mm 20
ART. 5959U ↓ mm 25
ART. 5962U ↓ mm 30
ART. 5963U ↓ mm 40

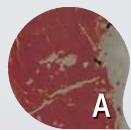

A
ASPEN
ART. 5958A ↓ mm 20
ART. 5959A ↓ mm 25
ART. 5962A ↓ mm 30
ART. 5963A ↓ mm 40



B
BLU
ART. 5958B ↓ mm 20
ART. 5959B ↓ mm 25
ART. 5962B ↓ mm 30
ART. 5963B ↓ mm 40



C
CARRARA
ART. 5958C ↓ mm 20
ART. 5959C ↓ mm 25
ART. 5962C ↓ mm 30
ART. 5963C ↓ mm 40



Z
LABRADOR
ART. 5958Z ↓ mm 20
ART. 5959Z ↓ mm 25
ART. 5962Z ↓ mm 30
ART. 5963Z ↓ mm 40



M
MELROSE
ART. 5958M ↓ mm 20
ART. 5959M ↓ mm 25
ART. 5962M ↓ mm 30
ART. 5963M ↓ mm 40

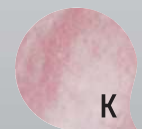

K
PINK
ART. 5958K ↓ mm 20
ART. 5959K ↓ mm 25
ART. 5962K ↓ mm 30
ART. 5963K ↓ mm 40



P
PORTOS
ART. 5958P ↓ mm 20
ART. 5959P ↓ mm 25
ART. 5962P ↓ mm 30
ART. 5963P ↓ mm 40



G
RED
ART. 5958G ↓ mm 20
ART. 5959G ↓ mm 25
ART. 5962G ↓ mm 30
ART. 5963G ↓ mm 40



R
ROMA
ART. 5958R ↓ mm 20
ART. 5959R ↓ mm 25
ART. 5962R ↓ mm 30
ART. 5963R ↓ mm 40



RB
ROSA BELLISSIMO
ART. 5958RB ↓ mm 20
ART. 5959RB ↓ mm 25
ART. 5962RB ↓ mm 30
ART. 5963RB ↓ mm 40



Y
ROSA DEL PORTOGALLO
ART. 5958Y ↓ mm 20
ART. 5959Y ↓ mm 25
ART. 5962Y ↓ mm 30
ART. 5963Y ↓ mm 40



RP
ROSA PORRINO
ART. 5958RP ↓ mm 20
ART. 5959RP ↓ mm 25
ART. 5962RP ↓ mm 30
ART. 5963RP ↓ mm 40



H
SAHARA
ART. 5958H ↓ mm 20
ART. 5959H ↓ mm 25
ART. 5962H ↓ mm 30
ART. 5963H ↓ mm 40

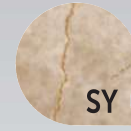

SY
SAHARA YELLOW
ART. 5958SY ↓ mm 20
ART. 5959SY ↓ mm 25
ART. 5962SY ↓ mm 30
ART. 5963SY ↓ mm 40



D
SARDINIA
ART. 5958D ↓ mm 20
ART. 5959D ↓ mm 25
ART. 5962D ↓ mm 30
ART. 5963D ↓ mm 40



T
SARDINIA BETA
ART. 5958T ↓ mm 20
ART. 5959T ↓ mm 25
ART. 5962T ↓ mm 30
ART. 5963T ↓ mm 40

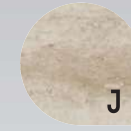

J
TRAVERTINO
ART. 5958J ↓ mm 20
ART. 5959J ↓ mm 25
ART. 5962J ↓ mm 30
ART. 5963J ↓ mm 40



TU
TURKEY
ART. 5958TU ↓ mm 20
ART. 5959TU ↓ mm 25
ART. 5962TU ↓ mm 30
ART. 5963TU ↓ mm 40



VG
VERDE GUATEMALA
ART. 5958VG ↓ mm 20
ART. 5959VG ↓ mm 25
ART. 5962VG ↓ mm 30
ART. 5963VG ↓ mm 40



V
VERONA
ART. 5958V ↓ mm 20
ART. 5959V ↓ mm 25
ART. 5962V ↓ mm 30
ART. 5963V ↓ mm 40

ETERNITY RIFLESSI



AZZURRO
ART. 5958AZL ↓ mm 20 spessore mm 7
ART. 5959AZL ↓ mm 25 spessore mm 7
ART. 5962AZL ↓ mm 30 spessore mm 7
ART. 5963AZL ↓ mm 40 spessore mm 7



BIANCO
ART. 5958BIL ↓ mm 20 spessore mm 7
ART. 5959BIL ↓ mm 25 spessore mm 7
ART. 5962BIL ↓ mm 30 spessore mm 7
ART. 5963BIL ↓ mm 40 spessore mm 7



BLU
ART. 5958BLL ↓ mm 20 spessore mm 7
ART. 5959BLL ↓ mm 25 spessore mm 7
ART. 5962BLL ↓ mm 30 spessore mm 7
ART. 5963BLL ↓ mm 40 spessore mm 7



VERDE
ART. 5958VEL ↓ mm 20 spessore mm 7
ART. 5959VEL ↓ mm 25 spessore mm 7
ART. 5962VEL ↓ mm 30 spessore mm 7
ART. 5963VEL ↓ mm 40 spessore mm 7



BEIGE
ART. 5958BEL ↓ mm 20 spessore mm 7
ART. 5959BEL ↓ mm 25 spessore mm 7
ART. 5962BEL ↓ mm 30 spessore mm 7
ART. 5963BEL ↓ mm 40 spessore mm 7



TORTORA
ART. 5958TOL ↓ mm 20 spessore mm 7
ART. 5959TOL ↓ mm 25 spessore mm 7
ART. 5962TOL ↓ mm 30 spessore mm 7
ART. 5963TOL ↓ mm 40 spessore mm 7



ROSSO
ART. 5958ROL ↓ mm 20 spessore mm 7
ART. 5959ROL ↓ mm 25 spessore mm 7
ART. 5962ROL ↓ mm 30 spessore mm 7
ART. 5963ROL ↓ mm 40 spessore mm 7



VIOLA
ART. 5958VIL ↓ mm 20 spessore mm 7
ART. 5959VIL ↓ mm 25 spessore mm 7
ART. 5962VIL ↓ mm 30 spessore mm 7
ART. 5963VIL ↓ mm 40 spessore mm 7



SATENE
ART. 5958STL ↓ mm 20 spessore mm 7
ART. 5959STL ↓ mm 25 spessore mm 7
ART. 5962STL ↓ mm 30 spessore mm 7
ART. 5963STL ↓ mm 40 spessore mm 7

Porcellana



SENZA PERNO

| | | |
|-----------|--------------------------------|---------------|
| ART. 5932 | Lettere/Numeri/Stella/Croce | ↓ mm 30 |
| ART. 5942 | Lettere/Numeri/Stella/Croce | ↓ mm 40 |
| ART. 5952 | Lettere/Numeri/ Stella/Croce | ↓ mm 50 |
| ART. 5981 | Punto/Accento/Virgola/Trattino | ↓ mm 30-40-50 |

CON PERNO

| | | |
|-----------|--------------------------------|-----------------|
| ART. 5934 | Lettere/Numeri/Stella/Croce | ↓ mm 30 |
| ART. 5944 | Lettere/Numeri/Stella/Croce | ↓ mm 40 |
| ART. 5954 | Lettere/Numeri/Stella/Croce | ↓ mm 50 |
| ART. 5974 | Lettere/Numeri | ↓ mm 70 |
| ART. 5967 | Punto/Accento/Virgola | x ↓ mm 30/40/50 |
| ART. 5967 | Trattino | x ↓ mm 30/40/50 |
| ART. 5975 | Punto/Accento/Virgola/Trattino | x ↓ mm 70 |

SMALTO BIANCO CON PERNO

| | | |
|-------------|-----------------------------|---------------|
| ART. 5934SB | Lettere/Numeri/Stella/Croce | ↓ mm 30 |
| ART. 5944SB | Lettere/Numeri/Stella/Croce | ↓ mm 40 |
| ART. 5954SB | Lettere/Numeri/Stella/Croce | ↓ mm 50 |
| ART. 5967SB | Punto Accento/Virgola | ↓ mm 30-40-50 |
| ART. 5967SB | Trattino | ↓ mm 30-40-50 |



SENZA PERNO

| | | |
|-----------|--------------------------------|---------------|
| ART. 5933 | Lettere/Numeri/Stella/Croce | ↓ mm 30 |
| ART. 5943 | Lettere/Numeri/Stella/Croce | ↓ mm 40 |
| ART. 5953 | Lettere/Numeri/ Stella/Croce | ↓ mm 50 |
| ART. 5961 | Punto Accento/Virgola/Trattino | ↓ mm 30-40-50 |

CON PERNO

| | | |
|-----------|-----------------------------|-----------------|
| ART. 5935 | Lettere/Numeri/Stella/Croce | ↓ mm 30 |
| ART. 5945 | Lettere/Numeri/Stella/Croce | ↓ mm 40 |
| ART. 5957 | Lettere/Numeri/Stella/Croce | ↓ mm 50 |
| ART. 5970 | Punto/Accento/Virgola | x ↓ mm 30 |
| ART. 5970 | Trattino | x ↓ mm 30/40/50 |

PER COMPOSIZIONE EPIGRAFI AUMENTO DEL 20%

PER COMPOSIZIONE EPIGRAFI AUMENTO DEL 20%

A B C

A B C



F
AFRICA
ART. MF34 ↓ mm 30
ART. MF44 ↓ mm 40
ART. MF54 ↓ mm 50
ART. MF74 ↓ mm 70



L
ALPI
ART. ML34 ↓ mm 30
ART. ML44 ↓ mm 40
ART. ML54 ↓ mm 50
ART. ML74 ↓ mm 70



U
APUANIA
ART. MU34 ↓ mm 30
ART. MU44 ↓ mm 40
ART. MU54 ↓ mm 50
ART. MU74 ↓ mm 70

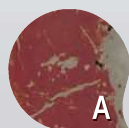

A
ASPEN
ART. MA34 ↓ mm 30
ART. MA44 ↓ mm 40
ART. MA54 ↓ mm 50
ART. MA74 ↓ mm 70



B
BLU
ART. MB34 ↓ mm 30
ART. MB44 ↓ mm 40
ART. MB54 ↓ mm 50
ART. MB74 ↓ mm 70



BM
BRONZO METALLIZZATO
ART. MBM34 ↓ mm 30
ART. MBM44 ↓ mm 40
ART. MBM54 ↓ mm 50
ART. MBM74 ↓ mm 70



C
CARRARA
ART. MC34 ↓ mm 30
ART. MC44 ↓ mm 40
ART. MC54 ↓ mm 50
ART. MC74 ↓ mm 70



Z
LABRADOR
ART. MZ34 ↓ mm 30
ART. MZ44 ↓ mm 40
ART. MZ54 ↓ mm 50
ART. MZ74 ↓ mm 70



M
MELROSE
ART. MM34 ↓ mm 30
ART. MM44 ↓ mm 40
ART. MM54 ↓ mm 50
ART. MM74 ↓ mm 70

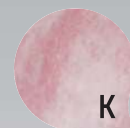

K
PINK
ART. MK34 ↓ mm 30
ART. MK44 ↓ mm 40
ART. MK54 ↓ mm 50
ART. MK74 ↓ mm 70



P
PORTOS
ART. MP34 ↓ mm 30
ART. MP44 ↓ mm 40
ART. MP54 ↓ mm 50
ART. MP74 ↓ mm 70



G
RED
ART. MG34 ↓ mm 30
ART. MG44 ↓ mm 40
ART. MG54 ↓ mm 50
ART. MG74 ↓ mm 70

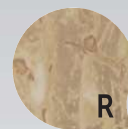

R
ROMA
ART. MR34 ↓ mm 30
ART. MR44 ↓ mm 40
ART. MR54 ↓ mm 50
ART. MR74 ↓ mm 70



RB
ROSA BELLISSIMO
ART. MRB34 ↓ mm 30
ART. MRB44 ↓ mm 40
ART. MRB54 ↓ mm 50
ART. MRB74 ↓ mm 70

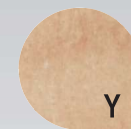

Y
ROSA DEL PORTOGALLO
ART. MY34 ↓ mm 30
ART. MY44 ↓ mm 40
ART. MY54 ↓ mm 50
ART. MY74 ↓ mm 70



RP
ROSA PORRINO
ART. MRP34 ↓ mm 30
ART. MRP44 ↓ mm 40
ART. MRP54 ↓ mm 50
ART. MRP74 ↓ mm 70

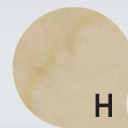

H
SAHARA
ART. MH34 ↓ mm 30
ART. MH44 ↓ mm 40
ART. MH54 ↓ mm 50
ART. MH74 ↓ mm 70

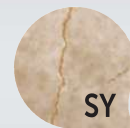

SY
SAHARA YELLOW
ART. MSY34 ↓ mm 30
ART. MSY44 ↓ mm 40
ART. MSY54 ↓ mm 50
ART. MSY74 ↓ mm 70



D
SARDINIA
ART. MD34 ↓ mm 30
ART. MD44 ↓ mm 40
ART. MD54 ↓ mm 50
ART. MD74 ↓ mm 70



T
SARDINIA BETA
ART. MT34 ↓ mm 30
ART. MT44 ↓ mm 40
ART. MT54 ↓ mm 50
ART. MT74 ↓ mm 70

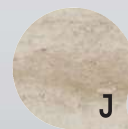

J
TRAVERTINO
ART. MJ34 ↓ mm 30
ART. MJ44 ↓ mm 40
ART. MJ54 ↓ mm 50
ART. MJ74 ↓ mm 70



TU
TURKEY
ART. MTU34 ↓ mm 30
ART. MTU44 ↓ mm 40
ART. MTU54 ↓ mm 50
ART. MTU74 ↓ mm 70



VG
VERDE GUATEMALA
ART. MVG34 ↓ mm 30
ART. MVG44 ↓ mm 40
ART. MVG54 ↓ mm 50
ART. MVG74 ↓ mm 70



V
VERONA
ART. MV34 ↓ mm 30
ART. MV44 ↓ mm 40
ART. MV54 ↓ mm 50
ART. MV74 ↓ mm 70

PUNTEGGIATURA COLOR

| | | |
|------------|----------|---------|
| ART. M968. | Punto | ↓ mm 30 |
| ART. M968- | Trattino | ↓ mm 30 |
| ART. M968, | Virgola | ↓ mm 30 |
| ART. M968' | Accento | ↓ mm 30 |

Porcellana

A RICHIESTA ARCADIA CON PERNO AUMENTO 30%



SMALTO BIANCO

ART. 5955SB Lettere ↓ mm 55

BIANCO

ART. 5955 Lettere ↓ mm 55

ART. 5985 Pax ↓ mm 55

NERO

ART. 5956 Lettere ↓ mm 55

ART. 5986 Pax ↓ mm 55

IVORY

ART. 5901 Lettere ↓ mm 55

ART. 5987 Pax ↓ mm 55

PER COMPOSIZIONE EPIGRAFI AUMENTO DEL 20%

Porcellana

A RICHIESTA ARCADIA CON PERNO AUMENTO 30%



SMALTO BIANCO

ART. 5930SB Lettere/Numeri/Stella/Croce ↓ mm 30

ART. 5992SB Accento ↓ mm 30

ART. 5996SB Trattino ↓ mm 30

ART. 5997SB Virgola ↓ mm 30

ART. 5999SB Punto ↓ mm 30

IVORY

ART. 5900 Lettere/Numeri/Stella/Croce ↓ mm 30

ART. 5907 Accento ↓ mm 30

ART. 5906 Trattino ↓ mm 30

ART. 5908 Virgola ↓ mm 30

ART. 5909 Punto ↓ mm 30

PER COMPOSIZIONE EPIGRAFI AUMENTO DEL 20%

BIANCO

ART. 5930 Lettere/Numeri/Stella/Croce ↓ mm 30

ART. 5992 Accento ↓ mm 30

ART. 5996 Trattino ↓ mm 30

ART. 5997 Virgola ↓ mm 30

ART. 5999 Punto ↓ mm 30

NERO

ART. 5931 Lettere/Numeri/Stella/Croce ↓ mm 30

ART. 5991 Accento ↓ mm 30

ART. 5993 Trattino ↓ mm 30

ART. 5994 Virgola ↓ mm 30

ART. 5995 Punto ↓ mm 30

PORCELLANA

A RICHIESTA ARCADIA COLOR CON PERNO AUMENTO 20%



PORCELLANA



AFRICA
ART. AF16 ↓ mm 80
ART. AF17 ↓ mm180
ART. AF30 ↓ mm 30
ART. AF55 ↓ mm 55
ART. AF85 Pax



ALPI
ART. AL16 ↓ mm 80
ART. AL17 ↓ mm180
ART. AL30 ↓ mm 30
ART. AL55 ↓ mm 55
ART. AL85 Pax



APUANIA
ART. AU16 ↓ mm 80
ART. AU17 ↓ mm180
ART. AU30 ↓ mm 30
ART. AU55 ↓ mm 55
ART. AU85 Pax

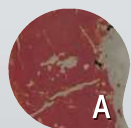

ASPEN
ART. AA16 ↓ mm 80
ART. AA17 ↓ mm180
ART. AA30 ↓ mm 30
ART. AA55 ↓ mm 55
ART. AA85 Pax



BLU
ART. AB16 ↓ mm 80
ART. AB17 ↓ mm180
ART. AB30 ↓ mm 30
ART. AB55 ↓ mm 55
ART. AB85 Pax



BRONZO METALLIZZATO
ART. ABM16 ↓ mm 80
ART. ABM17 ↓ mm180
ART. ABM30 ↓ mm 30
ART. ABM55 ↓ mm 55
ART. ABM85 Pax



CARRARA
ART. AC16 ↓ mm 80
ART. AC17 ↓ mm180
ART. AC30 ↓ mm 30
ART. AC55 ↓ mm 55
ART. AC85 Pax



LABRADOR
ART. AZ16 ↓ mm 80
ART. AZ17 ↓ mm180
ART. AZ30 ↓ mm 30
ART. AZ55 ↓ mm 55
ART. AZ85 Pax



MELROSE
ART. AM16 ↓ mm 80
ART. AM17 ↓ mm180
ART. AM30 ↓ mm 30
ART. AM55 ↓ mm 55
ART. AM85 Pax

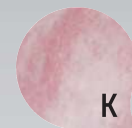

PINK
ART. AK16 ↓ mm 80
ART. AK17 ↓ mm180
ART. AK30 ↓ mm 30
ART. AK55 ↓ mm 55
ART. AK85 Pax



PORTOS
ART. AP16 ↓ mm 80
ART. AP17 ↓ mm180
ART. AP30 ↓ mm 30
ART. AP55 ↓ mm 55
ART. AP85 Pax



RED
ART. AG16 ↓ mm 80
ART. AG17 ↓ mm180
ART. AG30 ↓ mm 30
ART. AG55 ↓ mm 55
ART. AG85 Pax

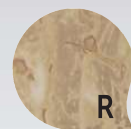

ROMA
ART. AR16 ↓ mm 80
ART. AR17 ↓ mm180
ART. AR30 ↓ mm 30
ART. AR55 ↓ mm 55
ART. AR85 Pax



ROSA BELLISSIMO
ART. ARB16 ↓ mm 80
ART. ARB17 ↓ mm180
ART. ARB30 ↓ mm 30
ART. ARB55 ↓ mm 55
ART. ARB85 Pax



ROSA DEL PORTOGALLO
ART. AY16 ↓ mm 80
ART. AY17 ↓ mm180
ART. AY30 ↓ mm 30
ART. AY55 ↓ mm 55
ART. AY85 Pax



ROSA PORRINO
ART. ARP16 ↓ mm 80
ART. ARP17 ↓ mm180
ART. ARP30 ↓ mm 30
ART. ARP55 ↓ mm 55
ART. ARP85 Pax



SAHARA
ART. AH16 ↓ mm 80
ART. AH17 ↓ mm180
ART. AH30 ↓ mm 30
ART. AH55 ↓ mm 55
ART. AH85 Pax

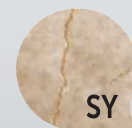

SAHARA YELLOW
ART. ASY16 ↓ mm 80
ART. ASY17 ↓ mm180
ART. ASY30 ↓ mm 30
ART. ASY55 ↓ mm 55
ART. ASY85 Pax



SARDINIA
ART. AD16 ↓ mm 80
ART. AD17 ↓ mm180
ART. AD30 ↓ mm 30
ART. AD55 ↓ mm 55
ART. AD85 Pax



SARDINIA BETA
ART. AT16 ↓ mm 80
ART. AT17 ↓ mm180
ART. AT30 ↓ mm 30
ART. AT55 ↓ mm 55
ART. AT85 Pax



TRAVERTINO
ART. AJ16 ↓ mm 80
ART. AJ17 ↓ mm180
ART. AJ30 ↓ mm 30
ART. AJ55 ↓ mm 55
ART. AJ85 Pax



TURKEY
ART. ATU16 ↓ mm 80
ART. ATU17 ↓ mm180
ART. ATU30 ↓ mm 30
ART. ATU55 ↓ mm 55
ART. ATU85 Pax



VERDE GUATEMALA
ART. AVG16 ↓ mm 80
ART. AVG17 ↓ mm180
ART. AVG30 ↓ mm 30
ART. AVG55 ↓ mm 55
ART. AVG85 Pax



VERONA
ART. AV16 ↓ mm 80
ART. AV17 ↓ mm180
ART. AV30 ↓ mm 30
ART. AV55 ↓ mm 55
ART. AV85 Pax

ISTRUZIONI di MONTAGGIO ARCADIA

La superficie di adesione deve essere perfettamente piana e levigata, marmo granito vetro cristallo ecc..



1.
Pulire accuratamente la lastra con alcool.

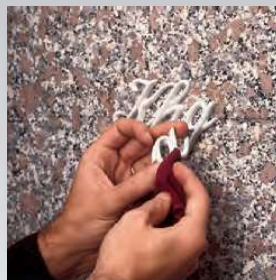

2.
Tracciare a matita la linea di posizionamento del carattere. Pulire accuratamente le lettere che debbono essere perfettamente asciutte e sgrassate con alcool.



3.
Stendere uno o due millimetri di spessore di resina siliconica neutra su tutta la superficie.



4.
Posizionare il carattere tenendo presente che, un perfetto allineamento si ottiene facendo collimare la traccia a matita con gli incastri della lettera.



5.
Premere leggermente



6.
A silicone asciutto eliminare le bave con un cutter o un piccolo scalpello affilato.

Vezzani

PORCELLANA

PORCELLANA BIANCA

ART. 5916 Lettere Minuscole ↓ cm 8

ART. 5917 Lettere Maiuscole ↓ cm 18

ART. 5920 Punto bianco ↓ cm 8

PORCELLANA NERA

ART. 5918 Lettere Minuscole ↓ cm 8

ART. 5919 Lettere Maiuscole ↓ mm 18

ART. 5921 Punto nero ↓ cm 8



Pipa Slava porcellana grande
ART. 5990 bianca
ART. 5990N nera



Pipa Slava porcellana piccola
ART. 5998 bianca
ART. 5998N nera



BIANCO e NERO
ART. 25100 4x16 cm

COLORI
ART. 25300 4x16 cm



BIANCO e NERO
ART. 25101 5x10 cm
ART. 25102 9x15 cm
ART. 25367 10x14 cm
ART. 25103 11x20 cm
ART. 25104 15x30 cm
ART. 25105 20x40 cm

COLORI
ART. 25301 5x10 cm
ART. 25302 9x15 cm
ART. 25368 10x14 cm
ART. 25303 11x20 cm
ART. 25304 15x30 cm
ART. 25305 20x40 cm



BIANCO e NERO
ART. 25254 10x16 cm
ART. 25255 12x21 cm
ART. 25256 15x26 cm
ART. 25257 17x31 cm
ART. 25258 20x36 cm
ART. 25259 22x41 cm

COLORI
ART. 25354 10x16 cm
ART. 25355 12x21 cm
ART. 25356 15x26 cm
ART. 25357 17x31 cm
ART. 25358 20x36 cm
ART. 25359 22x41 cm



BIANCO e NERO
ART. 25210 11x15 cm
ART. 25211 14x20 cm
ART. 25212 18x25 cm
ART. 25213 22x30 cm
ART. 25214 29x40 cm



BIANCO e NERO
ART. 25595 5x10 cm
ART. 25596 9x16 cm
ART. 25597 11x20 cm
ART. 25598 13x25 cm
ART. 25599 15x30 cm

COLORI
ART. 25845 5x10 cm
ART. 25846 9x16 cm
ART. 25847 11x20 cm
ART. 25848 13x25 cm
ART. 25849 15x30 cm



BIANCO e NERO
ART. 25222 5x10 cm
ART. 25223 9x15 cm
ART. 25224 11x20 cm
ART. 25225 13x25 cm
ART. 25226 15x30 cm
ART. 25227 18x35 cm
ART. 25228 20x40 cm

COLORI
ART. 25322 5x10 cm
ART. 25323 9x15 cm
ART. 25324 11x20 cm
ART. 25325 13x25 cm
ART. 25326 15x30 cm
ART. 25327 18x35 cm
ART. 25328 20x40 cm



BIANCO e NERO
ART. 25249 11x15 cm
ART. 25250 14x20 cm
ART. 25251 18x25 cm
ART. 25252 22x30 cm
ART. 25253 29x40 cm

COLORI
ART. 25349 11x15 cm
ART. 25350 14x20 cm
ART. 25351 18x25 cm
ART. 25352 22x30 cm
ART. 25353 29x40 cm

esempi di personalizzazioni



Sfondo a scelta + scritta e dedica



Sfondo a scelta + foto scontornata + scritta e dedica

I PREZZI DI QUESTI ARTICOLI SONO COMPRESIVI DI TUTTE LE VARIANTI: TESTI E/O FOTO E/O FONDO E/O COLORAZIONI MARMI E GRANITI



LIBRO BIANCO / NERO

- P** ART. 29654 ↓ 15 ↔ 17 cm
- ART. 29658 ↓ 21 ↔ 24 cm
- ART. 29655 ↓ 25 ↔ 28 cm
- ART. 29656 ↓ 30 ↔ 36 cm
- ART. 29657 ↓ 38 ↔ 43 cm

LIBRO COLORI

- P** ART. 29660 ↓ 15 ↔ 17 cm
- ART. 29661 ↓ 21 ↔ 24 cm
- ART. 29662 ↓ 25 ↔ 28 cm
- ART. 29663 ↓ 30 ↔ 36 cm
- ART. 29664 ↓ 38 ↔ 43 cm

- T** ART. 29650 ↓ 15 ↔ 17 cm
- ART. 29659 ↓ 21 ↔ 24 cm
- ART. 29651 ↓ 25 ↔ 28 cm
- ART. 29652 ↓ 30 ↔ 36 cm
- ART. 29653 ↓ 38 ↔ 43 cm

- T** ART. 29665 ↓ 15 ↔ 17 cm
- ART. 29666 ↓ 21 ↔ 24 cm
- ART. 29667 ↓ 25 ↔ 28 cm
- ART. 29668 ↓ 30 ↔ 36 cm
- ART. 29669 ↓ 38 ↔ 43 cm



LIBRO BIANCO / NERO

- ART. 29670 ↓ 18 ↔ 21 cm
- ART. 29671 ↓ 18 ↔ 30 cm
- ART. 29672 ↓ 23 ↔ 35 cm

LIBRO COLORI

- ART. 29690 ↓ 18 ↔ 21 cm
- ART. 29691 ↓ 18 ↔ 30 cm
- ART. 29692 ↓ 23 ↔ 35 cm



Foto a titolo di esempio

I PREZZI DI QUESTI ARTICOLI SONO COMPRESIVI DI TUTTE LE VARIANTI:
TESTO E/O FOTO E/O FONDO

I PREZZI DI QUESTI ARTICOLI SONO COMPRESIVI DI TUTTE LE VARIANTI:
TESTO E/O FOTO E/O FONDO

PORCELLANA



Fondo G



Fondo P



Fondo I



Fondo 15



Fondo 16



Fondo 17



Fondo Q



Fondo L



Fondo R



Fondo 18



Fondo 19



Fondo 20



Fondo S



Fondo V



Fondo X



Fondo 21



Fondo 22



Fondo 23



Fondo Z



Fondo T



Fondo K



Fondo 24



Fondo 25



Fondo 26



Fondo U



Fondo W



Fondo 27



Fondo B



Fondo O



ART. 29927 B/N ART. 29963 COLORI
 † 14,5 ↔ 26,2 * 6,5 cm † 14,5 ↔ 26,2 * 6,5 cm



ART. 29929 B/N ART. 29966 COLORI
 † 14,5 ↔ 26,2 * 6,5 cm † 14,5 ↔ 26,2 * 6,5 cm



ART. 29923 B/N ART. 29924 COLORI
 † 14,5 ↔ 26,2 * 6,5 cm † 14,5 ↔ 26,2 * 6,5 cm



ART. 29928 B/N ART. 29964 COLORI
 † 14,5 ↔ 26,2 * 6,5 cm † 14,5 ↔ 26,2 * 6,5 cm



ART. 29926 B/N* ART. 29965 COLORI*
 † 14,5 ↔ 26,2 * 6,5 cm † 14,5 ↔ 26,2 * 6,5 cm



ART. 29925 B/N ART. 29967 COLORI*
 † 14,5 ↔ 26,2 * 6,5 cm † 14,5 ↔ 26,2 * 6,5 cm

*Per ordinazioni aggiungere al codice articolo la lettera corrispondente alla colorazione scelta.
 *To place orders add to the article code the letter corresponding the selected colouring.

*Per ordinazioni aggiungere al codice articolo la lettera corrispondente alla colorazione scelta.
 *To place orders add to the article code the letter corresponding the selected colouring.

Foto a titolo di esempio



ART. 29935 B/N ART. 29973 COLORI
 † 14,5 ↔ 26 † 6,5 cm † 14,5 ↔ 26 † 6,5 cm



ART. 29937 B/N ART. 29970 COLORI
 † 14,5 ↔ 26 † 6,5 cm † 14,5 ↔ 26 † 6,5 cm



ART. 29934 B/N* ART. 29968 COLORI*
 † 14,5 ↔ 26 † 6,5 cm † 14,5 ↔ 26 † 6,5 cm



ART. 29930 B/N ART. 29931 COLORI
 † 14,5 ↔ 26 † 6,5 cm † 14,5 ↔ 26 † 6,5 cm

*Per ordinazioni aggiungere al codice articolo la lettera corrispondente alla colorazione scelta.
 *To place orders add to the article code the letter corresponding the selected colouring.



ART. 29933 B/N* ART. 29971 COLORI*
 † 14,5 ↔ 26 † 6,5 cm † 14,5 ↔ 26 † 6,5 cm



ART. 29932 B/N* ART. 29969 COLORI*
 † 14,5 ↔ 26 † 6,5 cm † 14,5 ↔ 26 † 6,5 cm

*Per ordinazioni aggiungere al codice articolo la lettera corrispondente alla colorazione scelta.
 *To place orders add to the article code the letter corresponding the selected colouring.

*Per ordinazioni aggiungere al codice articolo la lettera corrispondente alla colorazione scelta.
 *To place orders add to the article code the letter corresponding the selected colouring.

Foto a titolo di esempio



ART. 29918 B/N
↓ 14,5 ↔ 26 ↗ 6,5 cm

ART. 29919 COLORI
↓ 14,5 ↔ 26 ↗ 6,5 cm



ART. 29921 B/N*
↓ 14,5 ↔ 26 ↗ 6,5 cm

ART. 29961 COLORI*
↓ 14,5 ↔ 26 ↗ 6,5 cm

*Per ordinazioni aggiungere al codice articolo la lettera corrispondente alla colorazione scelta.
*To place orders add to the article code the letter corresponding the selected colouring.



ART. 29922 B/N*
↓ 14,5 ↔ 26 ↗ 6,5 cm

ART. 29962 COLORI*
↓ 14,5 ↔ 26 ↗ 6,5 cm



ART. 29920 B/N*
↓ 14,5 ↔ 26 ↗ 6,5 cm

ART. 29960 COLORI*
↓ 14,5 ↔ 26 ↗ 6,5 cm

*Per ordinazioni aggiungere al codice articolo la lettera corrispondente alla colorazione scelta.
*To place orders add to the article code the letter corresponding the selected colouring.

*Per ordinazioni aggiungere al codice articolo la lettera corrispondente alla colorazione scelta.
*To place orders add to the article code the letter corresponding the selected colouring.



ART. 29938 B/N ART. 29939 COLORI
 † 14,5 ↔ 26 † 6,5 cm † 14,5 ↔ 26 † 6,5 cm



ART. 29941 B/N* ART. 29975 COLORI*
 † 14,5 ↔ 26 † 6,5 cm † 14,5 ↔ 26 † 6,5 cm



ART. 29940 B/N* ART. 29974 COLORI*
 † 14,5 ↔ 26 † 6,5 cm † 14,5 ↔ 26 † 6,5 cm

*Per ordinazioni aggiungere al codice articolo la lettera corrispondente alla colorazione scelta.
 *To place orders add to the article code the letter corresponding the selected colouring.

Foto a titolo di esempio



DISPLAY IN CARTONE NEUTRO
 PERSONALIZZABILE
 ART. 90311
 † 26 ↔ 34 cm

Foto a titolo di esempio



PORCELLANA

SERIE **FIORI**

ROSA



ART. 25731
bordo platino Ø 4 cm

ART. 25732
bordo platino Ø 5,5 cm

ART. 25733
bordo platino Ø 7 cm



ART. 25728
bordo oro Ø 4 cm

ART. 25729
bordo oro Ø 5,5 cm

ART. 25730
bordo oro Ø 7 cm



ART. 25722
Ø 4 cm

ART. 25723
Ø 5,5 cm

ART. 25724
Ø 7 cm



ART. 25725
Ø 4 cm

ART. 25726
Ø 5,5 cm

ART. 25727
Ø 7 cm



ART. 25719
Ø 4 cm

ART. 25720
Ø 5,5 cm

ART. 25721
Ø 7 cm

ROSA



PORCELLANA

Essendo un prodotto lavorato manualmente, può presentare differenze di colore.
Being a manually processed product, there may be differences in colour.

Essendo un prodotto lavorato manualmente, può presentare differenze di colore.
Being a manually processed product, there may be differences in colour.

ORCHIDEA



ART. 25704
Ø 4 cm

ART. 25705
Ø 6 cm

ART. 25706
Ø 8 cm



ART. 25707
Ø 4 cm

ART. 25708
Ø 6 cm

ART. 25709
Ø 8 cm



ART. 25710
Ø 4 cm

ART. 25711
Ø 6 cm

ART. 25712
Ø 8 cm



ART. 25713
Ø 8 cm

ART. 25714
Ø 11 cm



ART. 25715
Ø 8 cm

ART. 25716
Ø 11 cm



ART. 25717
Ø 8 cm

ART. 25718
Ø 11 cm



PORCELLANA

GIGLIO

Essendo un prodotto lavorato manualmente, può presentare differenze di colore.
Being a manually processed product, there may be differences in colour.

Essendo un prodotto lavorato manualmente, può presentare differenze di colore.
Being a manually processed product, there may be differences in colour.

CALLA



ART. 25734
8,5 cm

ART. 25735
12 cm



ART. 25738
bordo platino
8,5 cm

ART. 25739
bordo platino
12 cm



ART. 25736
bordo oro
8,5 cm

ART. 25737
bordo oro
12 cm

FOGLIE

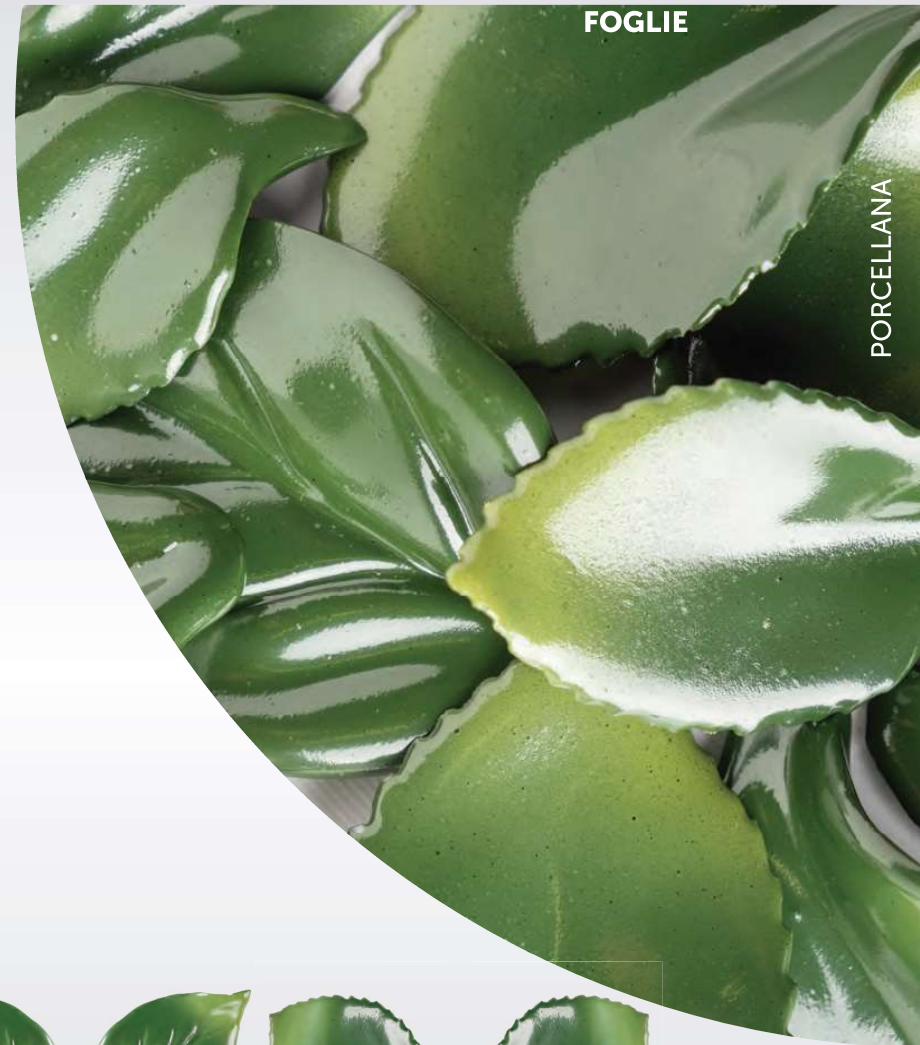

PORCELLANA



ART. 25749
sx piccola - 5,5 cm



ART. 25746
dx piccola - 5,5 cm



ART. 25743
sx piccola - 3 cm



ART. 25740
dx piccola - 3 cm



ART. 25750
sx media - 6,5 cm

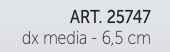

ART. 25747
dx media - 6,5 cm

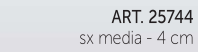

ART. 25744
sx media - 4 cm

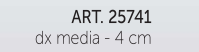

ART. 25741
dx media - 4 cm



ART. 25751
sx grande - 8 cm

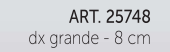

ART. 25748
dx grande - 8 cm

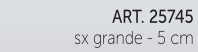

ART. 25745
sx grande - 5 cm

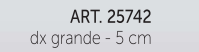

ART. 25742
dx grande - 5 cm

Essendo un prodotto lavorato manualmente, può presentare differenze di colore.
Being a manually processed product, there may be differences in colour.

Essendo un prodotto lavorato manualmente, può presentare differenze di colore.
Being a manually processed product, there may be differences in colour.

ROSA



ART. 25797
bordo platino
↓ 28 ↔ 12 ✦ 5,5 cm



ART. 25798
bordo platino
↓ 36 ↔ 15 ✦ 5,5 cm



ART. 25795
bordo oro
↓ 28 ↔ 12 ✦ 5,5 cm



ART. 25796
bordo oro
↓ 36 ↔ 15 ✦ 5,5 cm



ART. 25794
↓ 36 ↔ 15 ✦ 5,5 cm



ART. 25793
↓ 28 ↔ 12 ✦ 5,5 cm



ART. 25832
↓ 36 ↔ 15 ✦ 5,5 cm



ART. 25799
↓ 28 ↔ 12 ✦ 5,5 cm



ART. 25792
↓ 36 ↔ 15 ✦ 5,5 cm



ART. 25791
↓ 28 ↔ 12 ✦ 5,5 cm

ROSA



PORCELLANA

Essendo un prodotto lavorato manualmente, può presentare differenze di colore.
Being a manually processed product, there may be differences in colour.

Essendo un prodotto lavorato manualmente, può presentare differenze di colore.
Being a manually processed product, there may be differences in colour.

ORCHIDEA



ART. 25779
↓ 28 ↔ 10,5 ✕ 5,5 cm



ART. 25780
↓ 36 ↔ 16,5 ✕ 6,5 cm



ART. 25786
↓ 36 ↔ 17,5 ✕ 7,5 cm



ART. 25785
↓ 28 ↔ 11,5 ✕ 7,5 cm



ART. 25781
↓ 28 ↔ 10,5 ✕ 5,5 cm



ART. 25782
↓ 36 ↔ 16,5 ✕ 6,5 cm



ART. 25783
↓ 28 ↔ 10,5 ✕ 5,5 cm



ART. 25784
↓ 36 ↔ 16,5 ✕ 6,5 cm



ART. 25790
↓ 36 ↔ 17,5 ✕ 7,5 cm



ART. 25789
↓ 28 ↔ 11,5 ✕ 7,5 cm



ART. 25788
↓ 36 ↔ 17,5 ✕ 7,5 cm



ART. 25787
↓ 28 ↔ 11,5 ✕ 7,5 cm

GIGLIO



PORCELLANA

Essendo un prodotto lavorato manualmente, può presentare differenze di colore.
Being a manually processed product, there may be differences in colour.

Essendo un prodotto lavorato manualmente, può presentare differenze di colore.
Being a manually processed product, there may be differences in colour.



ART. 25834
↓ 36 ↔ 15 ↗ 6,5 cm



ART. 25833
↓ 28 ↔ 11 ↗ 5,5 cm



ART. 25838
bordo platino
↓ 36 ↔ 15 ↗ 6,5 cm



ART. 25837
bordo platino
↓ 28 ↔ 11 ↗ 5,5 cm



ART. 25836
bordo oro
↓ 36 ↔ 15 ↗ 6,5 cm



ART. 25835
bordo oro
↓ 28 ↔ 11 ↗ 5,5 cm



PORCELLANA

Essendo un prodotto lavorato manualmente, può presentare differenze di colore.
Being a manually processed product, there may be differences in colour.



ART. 25772
 † 37 ↔ 10 † 6,5 cm



ART. 25771
 † 19,5 ↔ 11 † 8 cm



ART. 25770
 bordo platino
 † 19,5 ↔ 11 † 8 cm



ART. 25839
 bordo platino
 † 37 ↔ 10 † 6,5 cm



ART. 25768
 bordo oro
 † 19,5 ↔ 11 † 8 cm



ART. 25769
 bordo oro
 † 37 ↔ 10 † 6,5 cm



ART. 25767
 † 37 ↔ 10 † 6,5 cm



ART. 25766
 † 19,5 ↔ 11 † 8 cm



ART. 25765
 † 37 ↔ 10 † 6,5 cm



ART. 25764
 † 19,5 ↔ 11 † 8 cm

Essendo un prodotto lavorato manualmente, può presentare differenze di colore.
 Being a manually processed product, there may be differences in colour.

Essendo un prodotto lavorato manualmente, può presentare differenze di colore.
 Being a manually processed product, there may be differences in colour.



PORCELLANA



ART. 25752
↑ 19,5 ↔ 11,5 ↗ 8 cm



ART. 25753
↑ 35 ↔ 10,5 ↗ 7 cm



ART. 25759
↑ 35 ↔ 12,5 ↗ 7 cm



ART. 25758
↑ 19,5 ↔ 11,5 ↗ 8 cm



ART. 25754
↑ 19,5 ↔ 11,5 ↗ 8 cm



ART. 25755
↑ 35 ↔ 10,5 ↗ 7 cm



ART. 25756
↑ 19,5 ↔ 11,5 ↗ 8 cm



ART. 25757
↑ 35 ↔ 10,5 ↗ 7 cm



ART. 25761
↑ 35 ↔ 12,5 ↗ 7 cm



ART. 25760
↑ 19,5 ↔ 11,5 ↗ 8 cm



ART. 25763
↑ 35 ↔ 12,5 ↗ 7 cm



ART. 25762
↑ 19,5 ↔ 11,5 ↗ 8 cm

Essendo un prodotto lavorato manualmente, può presentare differenze di colore.
Being a manually processed product, there may be differences in colour.

Essendo un prodotto lavorato manualmente, può presentare differenze di colore.
Being a manually processed product, there may be differences in colour.



PORCELLANA



ART. 25774
‡ 37 ↔ 12 † 7 cm



ART. 25773
‡ 19,5 ↔ 10 † 7 cm



ART. 25778
bordo platino
‡ 37 ↔ 12 † 7 cm



ART. 25777
bordo platino
‡ 19,5 ↔ 10 † 7 cm



ART. 25776
bordo oro
‡ 37 ↔ 12 † 7 cm



ART. 25775
bordo oro
‡ 19,5 ↔ 10 † 7 cm

Essendo un prodotto lavorato manualmente, può presentare differenze di colore.
Being a manually processed product, there may be differences in colour.

Composizioni floreali in porcellana per portafiori da cm 20
INTERNO ART. 73672



ROSE
ART. 25400
↓ 29,5 ↔ 22,5 cm



COMPOSIZIONE
ART. 25401
↓ 29,5 ↔ 22,5 cm



ORCHIDEA
ART. 25402
↓ 29,5 ↔ 22,5 cm

H = corrispondente alla sola composizione

Composizioni floreali in porcellana per portafiori da cm 20
INTERNO ART. 73974



COMPOSIZIONE
ART. 25404
↓ 29 ↔ 24,5 cm



ORCHIDEA
ART. 25405
↓ 29 ↔ 24,5 cm



ROSE
ART. 25403
↓ 29 ↔ 24,5 cm

H = corrispondente alla sola composizione

Composizioni floreali in porcellana per vaschette
INTERNO ART. 73651

Composizioni floreali in porcellana



COMPOSIZIONE
ART. 25407
↓ 38 ↔ 29 cm

ROSE
ART. 25406
↓ 38 ↔ 29 cm

ORCHIDEA
ART. 25408
↓ 38 ↔ 29 cm

H = corrispondente alla sola composizione



ROSE
ART. 25409
↓ 14 ↔ 10,5 cm



COMPOSIZIONE
ART. 25410
↓ 14 ↔ 10,5 cm



COMPOSIZIONE
ART. 25411
↓ 14 ↔ 10,5 cm

PER OSSARI

Questa composizione
si può adattare negli
ossari aventi come
interno plastica
*This composition
can be used for small
vases with a plastic
interior.*

INTERNO
ART. 73670

PORCELLANA

**PER OSSARI
Serie LONDON**

Composizioni floreali
in porcellana per
ossario serie London.
*Floral composition
in porcelain for small
vase London series.*

INTERNO
ART. 70209



ROSE
ART. 25412
↓ 13,5 ↔ 10,5 cm



COMPOSIZIONE
ART. 25414
↓ 13,5 ↔ 10,5 cm



COMPOSIZIONE
ART. 25413
↓ 13,5 ↔ 10,5 cm



ROSE
ART. 25415
↓ 12 ↔ 10,5 cm



CALLE
ART. 25416
↓ 12 ↔ 10,5 cm



COMPOSIZIONE
ART. 25417
↓ 12 ↔ 10,5 cm

PORTAORCHIDEA

Composizioni floreali
in porcellana per
PORTAORCHIDEA
*Floral composition
in porcelain for
orchid vase.*

INTERNO
ART. 70261M

H = corrispondente
alla sola composizione

Esempi di applicazioni su portafiori e vaschette



Esempi di applicazioni su ossari e portaorchidea



PORCELLANA



ROSE
ART. 25418
↓ 13 ↔ 8,5 cm



MARGHERITE
ART. 25420
↓ 14 ↔ 9 cm



ORCHIDEE
ART. 25422
↓ 13,5 ↔ 9 cm



ROSE
ART. 25419
↓ 21,5 ↔ 12 cm



MARGHERITE
ART. 25421
↓ 22 ↔ 13 cm



ORCHIDEE
ART. 25423
↓ 21,5 ↔ 13 cm



ROSE
ART. 25424
↓ 23 ↔ 58 cm

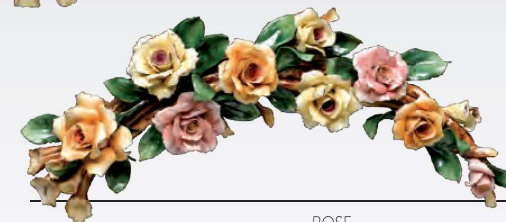

ROSE
ART. 25425
↓ 21,5 ↔ 52 cm



ROSE
ART. 25426
↓ 24 ↔ 44 cm



ROSE
ART. 25427
↓ 17 ↔ 48,5 cm



COMPOSIZIONE
ART. 25428
↓ 22 ↔ 46 cm



COMPOSIZIONE
ART. 25429
↓ 23,5 ↔ 52 cm

Composizioni floreali in porcellana



COMPOSIZIONE
ART. 25432
↓ 37 ↔ 23 cm



COMPOSIZIONE
ART. 25433
↓ 34 ↔ 22 cm



COMPOSIZIONE
ART. 25434
↓ 33,5 ↔ 22 cm



COMPOSIZIONE
ART. 25435
↓ 33 ↔ 22 cm



COMPOSIZIONE
ART. 25430
↓ 16 ↔ 46 cm



COMPOSIZIONE
ART. 25431
↓ 17 ↔ 45,5 cm



MARMO

SERIE MARMO

Marmo di Carrara



ART. YC7545 P
↓ 20 ↔ 12 cm



ART. YC7045 P
↓ 20 ↔ 12 cm

ART. YB7545 P
↓ 20 ↔ 12 cm



ART. YB7045 P
↓ 20 ↔ 12 cm



ART. YC9545 P
↓ 20 ↔ 18 cm



ART. YC9045 P
↓ 20 ↔ 18 cm

ART. YC7549 P
↓ 13 ↔ 8 cm



ART. YC7049 P
↓ 13 ↔ 8 cm



ART. YB7549 P
↓ 13 ↔ 8 cm



ART. YB7049 P
↓ 13 ↔ 8 cm



ART. YB9545 P
↓ 20 ↔ 18 cm

ART. YB9045 P
↓ 20 ↔ 18 cm



MARMO



ART. YC6545 Ø 5
↓ 20 ↔ 10,5 cm



ART. YC6549 Ø 4
↓ 16 ↔ 8,5 cm



ART. YC0106 9x12 cm
ART. YC0107 11x15 cm
ART. YC0108 13x18 cm



ART. YC0158 9x12 cm
ART. YC0160 11x15 cm
ART. YC0161 13x18 cm



ART. YC4114
↓ 20 cm



ART. YB6545 Ø 5
↓ 20 ↔ 10,5 cm



ART. YB6549 Ø 4
↓ 16 ↔ 8,5 cm



ART. YB0106 9x12 cm
ART. YB0107 11x15 cm
ART. YB0108 13x18 cm



ART. YB0158 9x12 cm
ART. YB0160 11x15 cm
ART. YB0161 13x18 cm



ART. YB4114
↓ 20 cm

ART. YC6045 Ø 5
↓ 20 ↔ 10,5 cm

ART. YC6049 Ø 4
↓ 16 ↔ 8,5 cm

ART. YB6045 Ø 5
↓ 20 ↔ 10,5 cm

ART. YB6049 Ø 4
↓ 16 ↔ 8,5 cm

Marmo di Carrara

Marmo Botticino



ART. YC7543 P
↓ 20 ↔ 12 cm



ART. YC7043 P
↓ 20 ↔ 12 cm



ART. YB7543 P
↓ 20 ↔ 12 cm

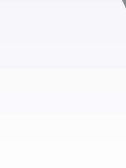

ART. YB7043 P
↓ 20 ↔ 12 cm



ART. YC9543 P
↓ 19 ↔ 18 cm



ART. YC9043 P
↓ 19 ↔ 18 cm



ART. YC7547 P
↓ 13,5 ↔ 8,5 cm



ART. YC7047 P
↓ 13,5 ↔ 8,5 cm



ART. YB7547 P
↓ 13,5 ↔ 8,5 cm



ART. YB7047 P
↓ 13,5 ↔ 8,5 cm



ART. YB9543 P
↓ 19 ↔ 18 cm

ART. YB9043 P
↓ 19 ↔ 18 cm



ART. YC6543 Ø 5 P
↓ 19 ↔ 10 cm



ART. YC6547 Ø 4 P
↓ 14,5 ↔ 8,5 cm



ART. YC0106 9x12 cm
ART. YC0107 11x15 cm
ART. YC0108 13x18 cm



ART. YC0158 9x12 cm
ART. YC0160 11x15 cm
ART. YC0161 13x18 cm



ART. YC4114
↓ 20 cm



ART. YB6543 Ø 5 P
↓ 19 ↔ 10 cm



ART. YB6547 Ø 4 P
↓ 14,5 ↔ 8,5 cm



ART. YB0106 9x12 cm
ART. YB0107 11x15 cm
ART. YB0108 13x18 cm



ART. YB0158 9x12 cm
ART. YB0160 11x15 cm
ART. YB0161 13x18 cm



ART. YB4114
↓ 20 cm

ART. YC6043 Ø 5 T
↓ 19 ↔ 10 cm

ART. YC6047 Ø 4 T
↓ 14,5 ↔ 8,5 cm

ART. YB6043 Ø 5 T
↓ 19 ↔ 10 cm

ART. YB6047 Ø 4 T
↓ 14,5 ↔ 8,5 cm

MARMO

Marmo di Carrara

Marmo Botticino



MARMO

ART. YC7532 P \updownarrow 20,5 ↔ 12 cm

ART. YC7024 P \updownarrow 20,5 ↔ 12 cm

ART. YC7533 R \updownarrow 20,5 ↔ 12 cm

ART. YC7027 R \updownarrow 20,5 ↔ 12 cm

ART. YB7532 P \updownarrow 20,5 ↔ 12 cm

ART. YB7024 P \updownarrow 20,5 ↔ 12 cm

ART. YB7533 R \updownarrow 20,5 ↔ 12 cm

ART. YB7027 R \updownarrow 20,5 ↔ 12 cm



ART. YC9015 P \updownarrow 20 ↔ 18,5 cm

ART. YC9016 R \updownarrow 20 ↔ 18,5 cm

ART. YC9017 P \updownarrow 20,5 ↔ 20 cm

ART. YC9018 INT ALLUMINIO \updownarrow 20,5 ↔ 20 cm

ART. YC6532 Ø 5 \updownarrow 21 ↔ 10,5 cm

ART. YC6032 Ø 5 \updownarrow 21 ↔ 10,5 cm

ART. YB6532 Ø 5 \updownarrow 21 ↔ 10,5 cm

ART. YB6032 Ø 5 \updownarrow 21 ↔ 10,5 cm

ART. YB9017 P \updownarrow 20,5 ↔ 20 cm

ART. YB9018 INT ALLUMINIO \updownarrow 20,5 ↔ 20 cm

ART. YB9015 P \updownarrow 20 ↔ 18,5 cm

ART. YB9016 R \updownarrow 20 ↔ 18,5 cm



ART. YC7513 P \updownarrow 13,5 ↔ 8 cm

ART. YC7013 P \updownarrow 13,5 ↔ 8 cm

ART. YC7514 R \updownarrow 13,5 ↔ 8 cm

ART. YC7014 R \updownarrow 13,5 ↔ 8 cm

ART. YC6513 Ø 4 \updownarrow 14 ↔ 8 cm

ART. YC6013 Ø 4 \updownarrow 14 ↔ 8 cm

ART. YC0106 9x12 cm

ART. YC0107 11x15 cm

ART. YC0108 13x18 cm

ART. YC0158 9x12 cm

ART. YC0160 11x15 cm

ART. YC0161 13x18 cm

ART. YC4114 \updownarrow 20 cm

ART. YB7513 P \updownarrow 13,5 ↔ 8 cm

ART. YB7514 R \updownarrow 13,5 ↔ 8 cm

ART. YB7013 P \updownarrow 13,5 ↔ 8 cm

ART. YB7014 R \updownarrow 13,5 ↔ 8 cm

ART. YB6513 Ø 4 \updownarrow 14 ↔ 8 cm

ART. YB6013 Ø 4 \updownarrow 14 ↔ 8 cm

ART. YB0106 9x12 cm

ART. YB0107 11x15 cm

ART. YB0108 13x18 cm

ART. YB0158 9x12 cm

ART. YB0160 11x15 cm

ART. YB0161 13x18 cm

ART. YB4114 \updownarrow 20 cm

Marmo di Carrara

Marmo Botticino



ART. YC7550 P
↓ 20,5 ↔ 12 cm

ART. YC7050 P T
↓ 20,5 ↔ 12 cm

ART. YC7551 R
↓ 20,5 ↔ 12 cm

ART. YC7051 R
↓ 20,5 ↔ 12 cm

ART. YB7550 P
↓ 20,5 ↔ 12 cm

ART. YB7050 P T
↓ 20,5 ↔ 12 cm

ART. YB7551 R
↓ 20,5 ↔ 12 cm

ART. YB7051 R
↓ 20,5 ↔ 12 cm



ART. YC9050 P T
↓ 20 ↔ 18,5 cm

ART. YC9052 P
↓ 20,5 ↔ 20 cm

ART. YC6534 Ø 5
↓ 21 ↔ 10,5 cm

ART. YB6534 Ø 5
↓ 21 ↔ 10,5 cm

ART. YB9052 P
↓ 20,5 ↔ 20 cm

ART. YB9050 P
↓ 20 ↔ 18,5 cm

ART. YC9051 R
↓ 20 ↔ 18,5 cm

ART. YC9053
INT. ALLUMINIO
↓ 20,5 ↔ 20 cm

ART. YC6014 Ø 5
↓ 21 ↔ 10,5 cm

ART. YB6014 Ø 5
↓ 21 ↔ 10,5 cm

ART. YB9053
INT. ALLUMINIO
↓ 20,5 ↔ 20 cm

ART. YB9051 R
↓ 20 ↔ 18,5 cm



ART. YC7552 P
↓ 13,5 ↔ 8 cm

ART. YC7052 P T
↓ 13,5 ↔ 8 cm

ART. YC6536 Ø 4
↓ 14 ↔ 8 cm

ART. YC0106
9x12 cm

ART. YC0158
9x12 cm

ART. YC4114
↓ 20 cm

ART. YB7552 P
↓ 13,5 ↔ 8 cm

ART. YB7052 P T
↓ 13,5 ↔ 8 cm

ART. YB6536 Ø 4
↓ 14 ↔ 8 cm

ART. YB0106
9x12 cm

ART. YB0158
9x12 cm

ART. YB4114
↓ 20 cm

ART. YC7553 R
↓ 13,5 ↔ 8 cm

ART. YC7053 R
↓ 13,5 ↔ 8 cm

ART. YC6016 Ø 4
↓ 14 ↔ 8 cm

ART. YC0107
11x15 cm

ART. YC0160
11x15 cm

ART. YC0161
13x18 cm

ART. YB7553 R
↓ 13,5 ↔ 8 cm

ART. YB7053 R
↓ 13,5 ↔ 8 cm

ART. YB6016 Ø 4
↓ 14 ↔ 8 cm

ART. YB0107
11x15 cm

ART. YB0160
11x15 cm

ART. YB0161
13x18 cm

MARMO

Marmo di Carrara

Marmo Botticino



ART. YC7530 P
↓ 20 ↔ 13 cm

ART. YC7030 P
↓ 20 ↔ 13 cm

ART. YC7531 R
↓ 20 ↔ 13 cm

ART. YC7031 R
↓ 20 ↔ 13 cm

ART. YB7530 P
↓ 20 ↔ 13 cm

ART. YB7030 P
↓ 20 ↔ 13 cm

ART. YB7531 R
↓ 20 ↔ 13 cm

ART. YB7031 R
↓ 20 ↔ 13 cm



ART. YC9026 P
↓ 20 ↔ 19 cm

ART. YC9012 P
↓ 21 ↔ 20,5 cm

ART. YC9027 R
↓ 20 ↔ 19 cm

ART. YC9013
INT. ALLUMINIO
↓ 21 ↔ 20,5 cm

ART. YB9012 P
↓ 21 ↔ 20,5 cm

ART. YB9013
INT. ALLUMINIO
↓ 21 ↔ 20,5 cm

ART. YB9026 P
↓ 20 ↔ 19 cm

ART. YB9027 R
↓ 20 ↔ 19 cm



ART. YC6530 Ø 5
↓ 21 ↔ 10 cm

ART. YC6030 Ø 5
↓ 21 ↔ 10 cm

ART. YC0106 9x12 cm
ART. YC0107 11x15 cm
ART. YC0108 13x18 cm

ART. YC0158 9x12 cm
ART. YC0160 11x15 cm
ART. YC0161 13x18 cm

ART. YC4114
↓ 20 cm



ART. YB6530 Ø 5
↓ 21 ↔ 10 cm

ART. YB6030 Ø 5
↓ 21 ↔ 10 cm

ART. YB0106 9x12 cm
ART. YB0107 11x15 cm
ART. YB0108 13x18 cm

ART. YB0158 9x12 cm
ART. YB0160 11x15 cm
ART. YB0161 13x18 cm

ART. YB4114
↓ 20 cm

MARMO

Marmo di Carrara

Marmo Botticino



MARMO

- | | | | |
|-----------------------------------|---------------------------------|-----------------------------------|---------------------------------|
| ART. YC7537 P ↓ 20 ↔ 12,5 cm | ART. YC7037 P ↓ 20 ↔ 12,5 cm | ART. YB7537 P ↓ 20 ↔ 12,5 cm | ART. YB7037 P ↓ 20 ↔ 12,5 cm |
| ART. YC7538 R ↓ 20,5 ↔ 12,5 cm | ART. YC7038 R ↓ 20 ↔ 12,5 cm | ART. YB7538 R ↓ 20,5 ↔ 12,5 cm | ART. YB7038 R ↓ 20 ↔ 12,5 cm |



- | | |
|---------------------------------|---------------------------------|
| ART. YC9030 P ↓ 20 ↔ 19,5 cm | ART. YB9030 P ↓ 20 ↔ 19,5 cm |
| ART. YC9031 R ↓ 20 ↔ 19,5 cm | ART. YB9031 R ↓ 20 ↔ 19,5 cm |



- | | | | | |
|-----------------------------------|-----------------------------------|---|---|------------------------|
| ART. YC6537 Ø 5 ↓ 20,5 ↔ 10 cm | ART. YC6037 Ø 5 ↓ 20,5 ↔ 10 cm | ART. YC0106 9x12 cm ART. YC0107 11x15 cm ART. YC0108 13x18 cm | ART. YC0158 9x12 cm ART. YC0160 11x15 cm ART. YC0161 13x18 cm | ART. YC4114 ↓ 20 cm |
|-----------------------------------|-----------------------------------|---|---|------------------------|



- | | | | | |
|-----------------------------------|-----------------------------------|---|---|------------------------|
| ART. YB6537 Ø 5 ↓ 20,5 ↔ 10 cm | ART. YB6037 Ø 5 ↓ 20,5 ↔ 10 cm | ART. YB0106 9x12 cm ART. YB0107 11x15 cm ART. YB0108 13x18 cm | ART. YB0158 9x12 cm ART. YB0160 11x15 cm ART. YB0161 13x18 cm | ART. YB4114 ↓ 20 cm |
|-----------------------------------|-----------------------------------|---|---|------------------------|

Marmo di Carrara

Marmo Botticino



MARMO

ART. YC7525 P **P**
↓ 20 ↔ 14 cm

ART. YC7025 P **T**
↓ 20 ↔ 14 cm

ART. YB7525 P **P**
↓ 20 ↔ 14 cm

ART. YB7025 P **T**
↓ 20 ↔ 14 cm

ART. YC7526 R
↓ 20 ↔ 14 cm

ART. YC7026 R
↓ 20 ↔ 14 cm

ART. YB7526 R
↓ 20 ↔ 14 cm

ART. YB7026 R
↓ 20 ↔ 14 cm



ART. YC9005 P **P T**
↓ 19 ↔ 19 cm

ART. YC9007 P **P**
↓ 20 ↔ 20 cm

ART. YC6525 Ø 5 **P**
↓ 21 ↔ 10 cm

ART. YB6525 Ø 5 **P**
↓ 21 ↔ 10 cm

ART. YB9007 P **P**
↓ 20 ↔ 20 cm

ART. YB9005 P **P T**
↓ 19 ↔ 19 cm

ART. YC9006 R **P T**
↓ 19 ↔ 19 cm

ART. YC9008 R **P**
↓ 19 ↔ 19 cm

ART. YC6025 Ø 5 **T**
↓ 21 ↔ 10 cm

ART. YB6025 Ø 5 **T**
↓ 21 ↔ 10 cm

ART. YB9008 R **P**
↓ 19 ↔ 19 cm

ART. YB9006 R **P T**
↓ 19 ↔ 19 cm



ART. YC0106
9x12 cm
ART. YC0107
11x15 cm
ART. YC0108
13x18 cm

ART. YC0109
9x12 cm
ART. YC0110
11x15 cm
ART. YC0111
13x18 cm

ART. YC0158
9x12 cm
ART. YC0160
11x15 cm
ART. YC0161
13x18 cm

ART. YC0162
9x12 cm
ART. YC0164
11x15 cm
ART. YC0165
13x18 cm

ART. YC4114
↓ 20 cm
ART. YC4115
↓ 20 cm

ART. YB0106
9x12 cm
ART. YB0107
11x15 cm
ART. YB0108
13x18 cm

ART. YB0109
9x12 cm
ART. YB0110
11x15 cm
ART. YB0111
13x18 cm

ART. YB0158
9x12 cm
ART. YB0160
11x15 cm
ART. YB0161
13x18 cm

ART. YB0162
9x12 cm
ART. YB0164
11x15 cm
ART. YB0165
13x18 cm

ART. YB4114
↓ 20 cm
ART. YB4115
↓ 20 cm

Itaca



ART. YC7520 P ↓ 21 ↔ 13 cm
 ART. YC7521 R ↓ 21 ↔ 13 cm
 ART. YC7020 P ↓ 21 ↔ 13 cm
 ART. YC7021 R ↓ 21 ↔ 13 cm
 ART. YC6520 Ø 5 ↓ 21 ↔ 11 cm
 ART. YC6020 Ø 5 ↓ 21 ↔ 11 cm

Classica



ART. YC9001 P ↓ 20 ↔ 20 cm
 ART. YC9009 R ↓ 20 ↔ 20 cm
 ART. YC6000 Ø 5 ↓ 10 ↔ 16 cm

Itaca



ART. YB7520 P ↓ 21 ↔ 13 cm
 ART. YB7521 R ↓ 21 ↔ 13 cm
 ART. YB7020 P ↓ 21 ↔ 13 cm
 ART. YB7021 R ↓ 21 ↔ 13 cm
 ART. YB6520 Ø 5 ↓ 21 ↔ 11 cm
 ART. YB6020 Ø 5 ↓ 21 ↔ 11 cm

Classica



ART. YB9001 P ↓ 20 ↔ 20 cm
 ART. YB9009 R ↓ 20 ↔ 20 cm
 ART. YB6000 Ø 5 ↓ 10 ↔ 16 cm

Taormina



ART. YC9002 P ↓ 18,5 ↔ 18,5 cm
 ART. YC9010 R ↓ 18,5 ↔ 18,5 cm
 ART. YC6002 Ø 5 ↓ 10,5 ↔ 16 cm

Odeon



ART. YC9004 P ↓ 20 ↔ 19 cm
 ART. YC9011 R ↓ 20 ↔ 19 cm
 ART. YC6004 Ø 5 ↓ 11 ↔ 14,5 cm

Taormina



ART. YB9002 P ↓ 18,5 ↔ 18,5 cm
 ART. YB9010 R ↓ 18,5 ↔ 18,5 cm
 ART. YB6002 Ø 5 ↓ 10,5 ↔ 16 cm

Odeon



ART. YB9004 P ↓ 20 ↔ 19 cm
 ART. YB9011 R ↓ 20 ↔ 19 cm
 ART. YB6004 Ø 5 ↓ 11 ↔ 14,5 cm



ART. YC0106 9x12 cm
 ART. YC0107 11x15 cm
 ART. YC0108 13x18 cm



ART. YC0158 9x12 cm
 ART. YC0160 11x15 cm
 ART. YC0161 13x18 cm



ART. YC4114 ↓ 20 cm



ART. YB0106 9x12 cm
 ART. YB0107 11x15 cm
 ART. YB0108 13x18 cm



ART. YB0158 9x12 cm
 ART. YB0160 11x15 cm
 ART. YB0161 13x18 cm



ART. YB4114 ↓ 20 cm



ART. YC7015 P
↓ 13,5 ↔ 8 cm

ART. YC7016 R
↓ 13,5 ↔ 8 cm



ART. YC7515 P
↓ 13,5 ↔ 8 cm

ART. YC7516 R
↓ 13,5 ↔ 8 cm



ART. YC6515 Ø 4
↓ 15,5 ↔ 7,5 cm

ART. YC6015 Ø 4
↓ 15,5 ↔ 7,5 cm



ART. YB7015 P
↓ 13,5 ↔ 8 cm

ART. YB7016 R
↓ 13,5 ↔ 8 cm



ART. YB7515 P
↓ 13,5 ↔ 8 cm

ART. YB7516 R
↓ 13,5 ↔ 8 cm



ART. YB6515 Ø 4
↓ 15,5 ↔ 7,5 cm

ART. YB6015 Ø 4
↓ 15,5 ↔ 7,5 cm

*Calcarì compatti
assemblati da leganti*

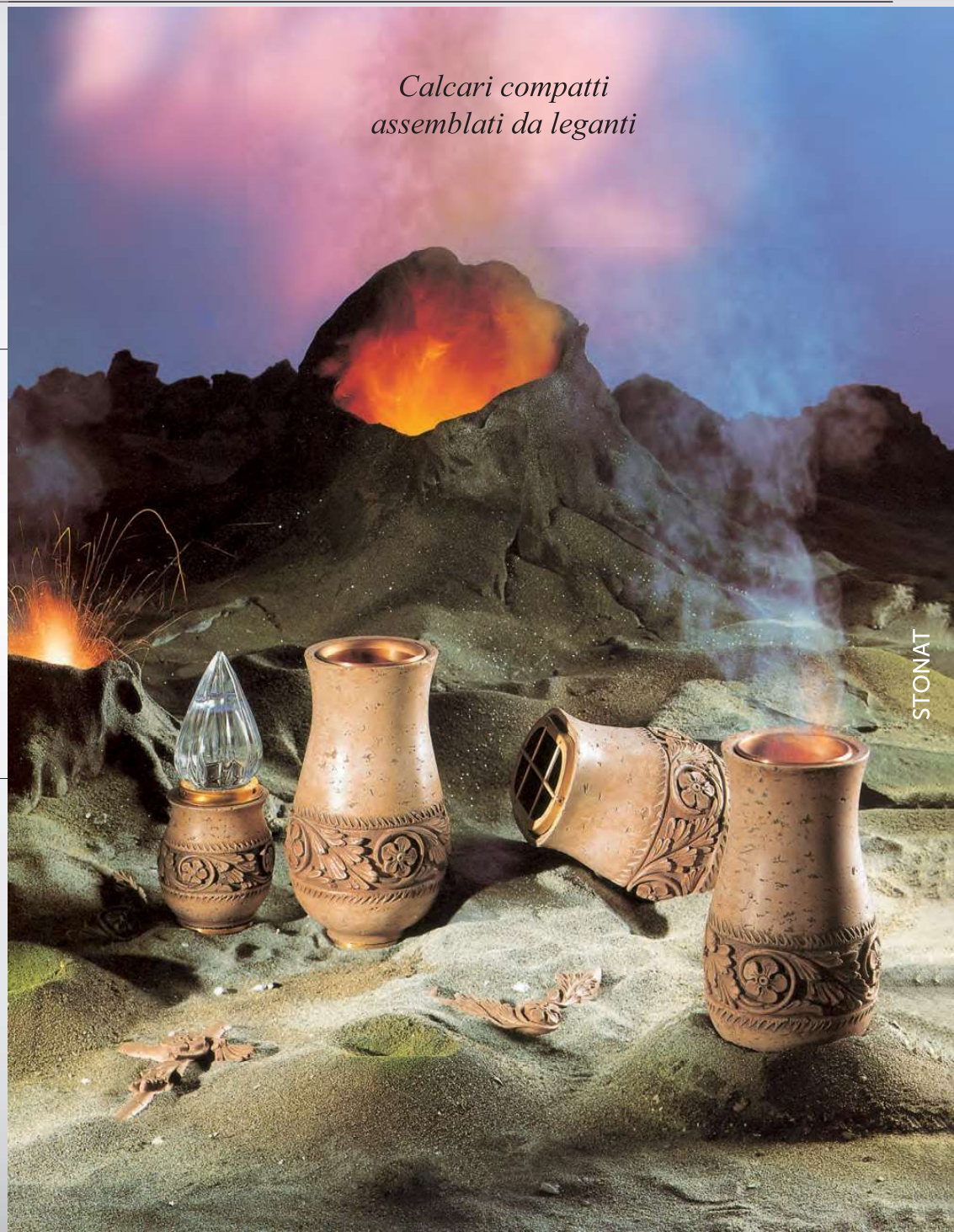

STONAT

Fusione a terra
è un altro tassello della
qualità firmata Vezzani



Fusione a cera persa
ogni oggetto è un'opera unica.
La produzione del bronzo avviene
dal metodo più antico e pregiato
della cera persa



Pressofusione



Lucidatura e verniciatura
Ogni fase del ciclo produttivo
aggiunge qualità al prodotto finale.



BRONZO



P. 12
SERIE **VOLO**



P. 26
SERIE **ETRURIA**



P. 32
SERIE **FORMAT**



P. 76
SERIE **ARMONIA**



P. 78
SERIE **RAFFAELLO**



P. 82
SERIE **EDEN**



P. 36
SERIE **HARP**



P. 40
SERIE **NETTUNO**



P. 46
SERIE **SPINNAKER**



P. 88
SERIE **ELEGANT**



P. 90
SERIE **GHIBLI**



P. 92
SERIE **MARSIGLIA**



P. 50
SERIE **AMADEUS**



P. 58
SERIE **GALA**



P. 60
SERIE **MIKI**



P. 96
SERIE **LOUVRE**



P. 98
SERIE **METROPOLITAN**



P. 102
SERIE **HERMITAGE**



P. 62
SERIE **SAMOA**



P. 64
SERIE **SIRIUS**



P. 66
SERIE **STRATOS**



P. 104
SERIE **UFFIZI**



P. 108
SERIE **PALACE**



P. 109
SERIE **HEBRON**



P. 68
SERIE **REGGIO**



P. 72
SERIE **NOVANTA**



P. 74
SERIE **MANTA**



P. 110
SERIE **DENNY ARTAL**



P. 111
SERIE **TRENTO**



ART. 47301 P
↓ 20,5 ↔ 11,5 cm

ART. 47033 P T
↓ 20,5 ↔ 11,5 cm



ART. 47300 P
↓ 12,5 ↔ 6 cm



ART. 47309 P
↓ 13 ↔ 7,5 cm



ART. 49339 P
↓ 17 ↔ 17 cm

ART. 49239 P T
↓ 17 ↔ 17 cm

ART. 47302 R
↓ 20,5 ↔ 11,5 cm

ART. 47047 R
↓ 20,5 ↔ 11,5 cm

ART. 47010 P T
↓ 13 ↔ 7,5 cm

ART. 49340 R
↓ 17 ↔ 17 cm

ART. 49240 R
↓ 17 ↔ 17 cm



ART. 46996 P
↓ 20 ↔ 13,5 cm

ART. 46696 T
↓ 20 ↔ 13,5 cm



ART. 46302 Ø 5 P
↓ 19 ↔ 9 cm

ART. 46002 Ø 5 T
↓ 19 ↔ 9 cm



ART. 46304 Ø 4 P
↓ 13 ↔ 6,5 cm

ART. 46004 Ø 4 T
↓ 13 ↔ 6,5 cm



ART. 31633 7x9 cm
ART. 31663 8x10 cm
ART. 40106 9x12 cm
ART. 40107 11x15 cm
ART. 31664 13x18 cm



ART. 31635 7x9 cm
ART. 31636 8x10 cm
ART. 40126 9x12 cm
ART. 40127 10x15 cm
ART. 40128 11x15 cm
ART. 40139 13x18 cm



ART. 41136 ↓ 15 ↔ 6,5 cm
ART. 41137 ↓ 20 ↔ 9 cm
ART. 41138 ↓ 25 ↔ 11 cm
ART. 41139 ↓ 30 ↔ 13 cm
ART. 41140 ↓ 40 ↔ 18 cm
ART. 41141 ↓ 50 ↔ 21,5 cm

NOVITÀ

NUOVA COLORAZIONE **SATÈN**

Finitura lucida



Finitura opaca



Per ordinazioni aggiungere al codice articolo la sigla STL. Disponibile solo sulle serie **RIFLESSI**.
To place orders add to the article code the letter STL. Only available on the **RIFLESSI** series.

Per ordinazioni aggiungere al codice articolo la sigla STO. Disponibile solo sulle serie **RIFLESSI**.
To place orders add to the article code the letter STO. Only available on the **RIFLESSI** series.

Finitura lucida

Finitura opaca

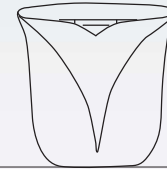

ART. 47301 P \updownarrow 20,5 \leftrightarrow 11,5 cm
 ART. 47302 R \updownarrow 20,5 \leftrightarrow 11,5 cm
 ART. 47033 P \updownarrow 20,5 \leftrightarrow 11,5 cm
 ART. 47047 R \updownarrow 20,5 \leftrightarrow 11,5 cm

ART. 49339 P \updownarrow 17 \leftrightarrow 17 cm
 ART. 49340 R \updownarrow 17 \leftrightarrow 17 cm
 ART. 49239 P \updownarrow 17 \leftrightarrow 17 cm
 ART. 49240 R \updownarrow 17 \leftrightarrow 17 cm



ART. 47300 P \updownarrow 12,5 \leftrightarrow 6 cm
 ART. 47309 P \updownarrow 13 \leftrightarrow 7,5 cm
 ART. 46996 P \updownarrow 20 \leftrightarrow 13,5 cm
 ART. 46696 T \updownarrow 20 \leftrightarrow 13,5 cm
 ART. 47010 P \updownarrow 13 \leftrightarrow 7,5 cm



ART. 41136 \updownarrow 15 \leftrightarrow 6,5 cm
 ART. 41137 \updownarrow 20 \leftrightarrow 9 cm
 ART. 41138 \updownarrow 25 \leftrightarrow 11 cm

ART. 31636 8x10 cm
 ART. 40126 9x12 cm
 ART. 40128 11x15 cm

ART. 31663 8x10 cm
 ART. 40106 9x12 cm
 ART. 40107 11x15 cm

ART. 46302 \emptyset 5 P \updownarrow 19 \leftrightarrow 9 cm
 ART. 46002 \emptyset 5 T \updownarrow 19 \leftrightarrow 9 cm

ART. 46304 \emptyset 4 P \updownarrow 13 \leftrightarrow 6,5 cm
 ART. 46004 \emptyset 4 T \updownarrow 13 \leftrightarrow 6,5 cm



Per ordinazioni aggiungere al codice articolo la sigla corrispondente alla colorazione scelta.
 To place orders add to the article code the letter corresponding the selected colouring.

Per ordinazioni aggiungere al codice articolo la sigla corrispondente alla colorazione scelta.
 To place orders add to the article code the letter corresponding the selected colouring.

NOVITÀ



ART. 47301MO P
↓ 20,5 ↔ 11,5 cm



ART. 47300MO P
↓ 12,5 ↔ 6 cm



ART. 47309MO P
↓ 13 ↔ 7,5 cm



ART. 49339MO P
↓ 17 ↔ 17 cm



ART. 46996MO P
↓ 20 ↔ 13,5 cm



ART. 46302MO Ø 5
↓ 19 ↔ 9 cm



ART. 46304MO Ø 4
↓ 13 ↔ 6,5 cm



ART. 31633MO 7x9 cm
ART. 31663MO 8x10 cm
ART. 40106MO 9x12 cm
ART. 40107MO 11x15 cm
ART. 31664MO 13x18 cm



ART. 31635MO 7x9 cm
ART. 31636MO 8x10 cm
ART. 40126MO 9x12 cm
ART. 40127MO 10x15 cm
ART. 40128MO 11x15 cm
ART. 40139MO 13x18 cm



ART. 41136MO ↓ 15 ↔ 6,5 cm
ART. 41137MO ↓ 20 ↔ 9 cm
ART. 41138MO ↓ 25 ↔ 11 cm
ART. 41139MO ↓ 30 ↔ 13 cm
ART. 41140MO ↓ 40 ↔ 18 cm
ART. 41141MO ↓ 50 ↔ 21,5 cm

NOVITÀ



ART. 47301DU P
↓ 20,5 ↔ 11,5 cm

ART. 47033DU P T
↓ 20,5 ↔ 11,5 cm



ART. 47300DU P P
↓ 12,5 ↔ 6 cm



ART. 47309DU P P
↓ 13 ↔ 7,5 cm



ART. 49339DU P P
↓ 17 ↔ 17 cm

ART. 47302DU R
↓ 20,5 ↔ 11,5 cm

ART. 47047DU R
↓ 20,5 ↔ 11,5 cm

ART. 47010DU P T
↓ 13 ↔ 7,5 cm

ART. 49340DU R
↓ 17 ↔ 17 cm

ART. 49239DU P T
↓ 17 ↔ 17 cm

ART. 49240DU R
↓ 17 ↔ 17 cm



ART. 46996DU P
↓ 20 ↔ 13,5 cm

ART. 46696DU T
↓ 20 ↔ 13,5 cm



ART. 46302DU Ø 5 P
↓ 19 ↔ 9 cm

ART. 46002DU Ø 5 T
↓ 19 ↔ 9 cm



ART. 46304DU Ø 4 P
↓ 13 ↔ 6,5 cm

ART. 46004DU Ø 4 T
↓ 13 ↔ 6,5 cm



ART. 31633DU 7x9 cm
ART. 31663DU 8x10 cm
ART. 40106DU 9x12 cm
ART. 40107DU 11x15 cm
ART. 31664DU 13x18 cm



ART. 31635DU 7x9 cm
ART. 31636DU 8x10 cm
ART. 40126DU 9x12 cm
ART. 40127DU 10x15 cm
ART. 40128DU 11x15 cm
ART. 40139DU 13x18 cm



ART. 41136DU ↓ 15 ↔ 6,5 cm
ART. 41137DU ↓ 20 ↔ 9 cm
ART. 41138DU ↓ 25 ↔ 11 cm
ART. 41139DU ↓ 30 ↔ 13 cm
ART. 41140DU ↓ 40 ↔ 18 cm
ART. 41141DU ↓ 50 ↔ 21,5 cm

primaria lega patinata carrara



ART. 47301CA P
↓ 20,5 ↔ 11,5 cm

ART. 47033CA P T
↓ 20,5 ↔ 11,5 cm

ART. 47302CA R
↓ 20,5 ↔ 11,5 cm

ART. 47047CA R
↓ 20,5 ↔ 11,5 cm



ART. 47301BO P
↓ 20,5 ↔ 11,5 cm

ART. 47033BO P T
↓ 20,5 ↔ 11,5 cm

ART. 47302BO R
↓ 20,5 ↔ 11,5 cm

ART. 47047BO R
↓ 20,5 ↔ 11,5 cm

primaria lega patinata botticino



ART. 49339CA P
↓ 17 ↔ 17 cm

ART. 49239CA P T
↓ 17 ↔ 17 cm



ART. 47309CA P
↓ 13 ↔ 7,5 cm

ART. 47300CA P
↓ 12,5 ↔ 6 cm



ART. 47300BO P
↓ 12,5 ↔ 6 cm



ART. 47309BO P
↓ 13 ↔ 7,5 cm



ART. 49339BO P
↓ 17 ↔ 17 cm

ART. 49239BO P T
↓ 17 ↔ 17 cm



ART. 46996CA P
↓ 20 ↔ 13,5 cm

ART. 46696CA T
↓ 20 ↔ 13,5 cm



ART. 46302CA P
Ø 5 ↓ 19 ↔ 9 cm

ART. 46002CA T
Ø 5 ↓ 19 ↔ 9 cm



ART. 46304CA P
Ø 4 ↓ 13 ↔ 6,5 cm

ART. 46004CA T
Ø 4 ↓ 13 ↔ 6,5 cm



ART. 46304BO P
Ø 4 ↓ 13 ↔ 6,5 cm

ART. 46004BO T
Ø 4 ↓ 13 ↔ 6,5 cm



ART. 46302BO P
Ø 5 ↓ 19 ↔ 9 cm

ART. 46002BO T
Ø 5 ↓ 19 ↔ 9 cm



ART. 46996BO P
↓ 20 ↔ 13,5 cm

ART. 46696BO T
↓ 20 ↔ 13,5 cm



- | | | | | | |
|------------------------------------|------------------------------------|---------------------------------|---------------------------------|--------------------------------|--------------------------------|
| ART. 47301BI P ↓ 20,5 ↔ 11,5 cm | ART. 47033BI P ↓ 20,5 ↔ 11,5 cm | ART. 47300BI P ↓ 12,5 ↔ 6 cm | ART. 47309BI P ↓ 13 ↔ 7,5 cm | ART. 49339BI P ↓ 17 ↔ 17 cm | ART. 49239BI P ↓ 17 ↔ 17 cm |
| ART. 47302BI R ↓ 20,5 ↔ 11,5 cm | ART. 47047BI R ↓ 20,5 ↔ 11,5 cm | | ART. 47010BI P ↓ 13 ↔ 7,5 cm | ART. 49340BI R ↓ 17 ↔ 17 cm | ART. 49240BI R ↓ 17 ↔ 17 cm |



- ART. 46996BI P
↓ 20 ↔ 13,5 cm
- ART. 46696BI T
↓ 20 ↔ 13,5 cm



- ART. 46302BI P
Ø 5 ↓ 19 ↔ 9 cm
- ART. 46002BI T
Ø 5 ↓ 19 ↔ 9 cm



- ART. 46304BI P
Ø 4 ↓ 13 ↔ 6,5 cm
- ART. 46004BI T
Ø 4 ↓ 13 ↔ 6,5 cm



- ART. 31633BI 7x9 cm
- ART. 31663BI 8x10 cm
- ART. 40106BI 9x12 cm
- ART. 40107BI 11x15 cm
- ART. 31664BI 13x18 cm



- ART. 31635BI 7x9 cm
- ART. 31636BI 8x10 cm
- ART. 40126BI 9x12 cm
- ART. 40127BI 10x15 cm
- ART. 40128BI 11x15 cm
- ART. 40139BI 13x18 cm



- ART. 41136BI ↓ 15 cm
- ART. 41137BI ↓ 20 cm
- ART. 41138BI ↓ 25 cm
- ART. 41139BI ↓ 30 cm
- ART. 41140BI ↓ 40 cm
- ART. 41141BI ↓ 50 cm



ART. 47272 P T
↓ 28,5 ↔ 15 cm



ART. 47303 P P
↓ 21 ↔ 11 cm



ART. 47269 P T
↓ 21 ↔ 11 cm



ART. 47307 P P
↓ 13,5 ↔ 7 cm



ART. 49335 P P
↓ 18 ↔ 16,5 cm

ART. 49336 R
↓ 18 ↔ 16,5 cm

ART. 49235 P T
↓ 18 ↔ 16,5 cm

ART. 49236 R
↓ 18 ↔ 16,5 cm



ART. 46694 T
↓ 23,5 ↔ 14 cm



ART. 46303 Ø 5 P
↓ 19,5 ↔ 7,5 cm

ART. 46010 Ø 5 T
↓ 19,5 ↔ 7,5 cm



ART. 46306 Ø 4 P
↓ 14 ↔ 6 cm

ART. 46009 Ø 4 T
↓ 14 ↔ 6 cm



ART. 40152 7x9 cm
ART. 40153 8x10 cm
ART. 40154 9x12 cm
ART. 40155 11x15 cm



ART. 40156 9x12 cm
ART. 40170 10x15 cm
ART. 40171 11x15 cm

Finitura lucida

Finitura opaca



ART. 47272 P **T**
 ↓ 28,5 ↔ 15 cm

ART. 47271 R
 ↓ 28,5 ↔ 15 cm

ART. 47303 P **P** ART. 47269 P **T**
 ↓ 21 ↔ 11 cm ↓ 21 ↔ 11 cm

ART. 47304 R ART. 47270 R
 ↓ 21 ↔ 11 cm ↓ 21 ↔ 11 cm



ART. 49335 P **P** ART. 49235 P **T**
 ↓ 18 ↔ 16,5 cm ↓ 18 ↔ 16,5 cm

ART. 49336 R ART. 49236 R
 ↓ 18 ↔ 16,5 cm ↓ 18 ↔ 16,5 cm

ART. 46694 **T**
 ↓ 23,5 ↔ 14 cm

ART. 47307 P **P** ART. 47267 P **T**
 ↓ 13,5 ↔ 7 cm ↓ 13,5 ↔ 7 cm



ART. 41136 ↓ 15 ↔ 6,5 cm
 ART. 41137 ↓ 20 ↔ 9 cm
 ART. 41138 ↓ 25 ↔ 11 cm

ART. 31636 8x10 cm
 ART. 40126 9x12 cm
 ART. 40128 11x15 cm

ART. 31663 8x10 cm
 ART. 40106 9x12 cm
 ART. 40107 11x15 cm

ART. 46303 Ø 5 **P** ART. 46010 Ø 5 **T**
 ↓ 19,5 ↔ 7,5 cm ↓ 19,5 ↔ 7,5 cm

ART. 46306 Ø 4 **P** ART. 46009 Ø 4 **T**
 ↓ 14 ↔ 6 cm ↓ 14 ↔ 6 cm



VEL VERDE LUCIDO
BIL BIANCO LUCIDO
BLL BLU LUCIDO
VIL VIOLA LUCIDO
ROL ROSSO LUCIDO
TOL TORTORA LUCIDO
BEL BEIGE LUCIDO
AZL AZZURRO LUCIDO
STL SATÈN LUCIDO



VEO VERDE OPACO
BIO BIANCO OPACO
BLO BLU OPACO
VIO VIOLA OPACO
ROO ROSSO OPACO
TOO TORTORA OPACO
BEO BEIGE OPACO
AZO AZZURRO OPACO
STO SATÈN OPACO

Per ordinazioni aggiungere al codice articolo la sigla corrispondente alla colorazione scelta,
 To place orders add to the article code the letter corresponding to the selected colouring.

Per ordinazioni aggiungere al codice articolo la sigla corrispondente alla colorazione scelta,
 To place orders add to the article code the letter corresponding to the selected colouring.

NOVITÀ



ART. 47272MO P **T**
↓ 28,5 ↔ 15 cm

ART. 47271MO R
↓ 28,5 ↔ 15 cm



ART. 47303MO P **P**
↓ 21 ↔ 11 cm

ART. 47304MO R
↓ 21 ↔ 11 cm

ART. 47269MO P **T**
↓ 21 ↔ 11 cm

ART. 47270MO R
↓ 21 ↔ 11 cm



ART. 47307MO P **P**
↓ 13,5 ↔ 7 cm

ART. 47267MO P **T**
↓ 13,5 ↔ 7 cm



ART. 49335MO P **P**
↓ 18 ↔ 16,5 cm

ART. 49336MO R
↓ 18 ↔ 16,5 cm

ART. 49235MO P **T**
↓ 18 ↔ 16,5 cm

ART. 49236MO R
↓ 18 ↔ 16,5 cm



ART. 46694MO **T**
↓ 23,5 ↔ 14 cm



ART. 46303MO Ø 5 **P**
↓ 19,5 ↔ 7,5 cm

ART. 46010MO Ø 5 **T**
↓ 19,5 ↔ 7,5 cm



ART. 46306MO Ø 4 **P**
↓ 14 ↔ 6 cm

ART. 46009MO Ø 4 **T**
↓ 14 ↔ 6 cm



ART. 40152MO 7x9 cm
ART. 40153MO 8x10 cm
ART. 40154MO 9x12 cm
ART. 40155MO 11x15 cm



ART. 40156MO 9x12 cm
ART. 40170MO 10x15 cm
ART. 40171MO 11x15 cm



ART. 47312 P
↓ 21 ↔ 11 cm

ART. 47273 P T
↓ 21 ↔ 11 cm



ART. 47315 P
↓ 13 ↔ 7 cm

ART. 47275 P T
↓ 13 ↔ 7 cm



ART. 49312 P
↓ 17,5 ↔ 16,5 cm

ART. 49212 P T
↓ 17,5 ↔ 16,5 cm



ART. 46312 Ø 5 P
↓ 20 ↔ 9 cm

ART. 46012 Ø 5 T
↓ 20 ↔ 9 cm



ART. 46315 Ø 4 P
↓ 13,5 ↔ 7 cm

ART. 46016 Ø 4 T
↓ 13,5 ↔ 7 cm



ART. 46948 P
↓ 19 ↔ 13,5 cm

ART. 46695 T
↓ 19 ↔ 13,5 cm



ART. 31633 7x9 cm
ART. 31663 8x10 cm
ART. 40106 9x12 cm
ART. 40107 11x15 cm
ART. 31664 13x18 cm



ART. 31635 7x9 cm
ART. 31636 8x10 cm
ART. 40126 9x12 cm
ART. 40127 10x15 cm
ART. 40128 11x15 cm
ART. 40139 13x18 cm



ART. 41136 ↓ 15 ↔ 6,5 cm
ART. 41137 ↓ 20 ↔ 9 cm
ART. 41138 ↓ 25 ↔ 11 cm
ART. 41139 ↓ 30 ↔ 13 cm
ART. 41140 ↓ 40 ↔ 18 cm
ART. 41141 ↓ 50 ↔ 21,5 cm

Finitura lucida

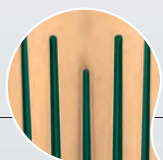

VEL
VERDE LUCIDO

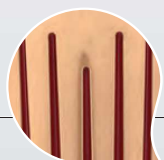

ROL
ROSSO LUCIDO

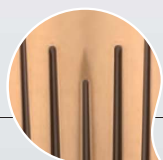

TOL
TORTORA LUCIDO



AZL
AZZURRO LUCIDO



ART. 47312 P
↓ 21 ↔ 11 cm

ART. 47313 R
↓ 21 ↔ 11 cm

ART. 47273 P T
↓ 21 ↔ 11 cm

ART. 47274 R
↓ 21 ↔ 11 cm



ART. 47315 P
↓ 13 ↔ 7 cm

ART. 47316 R
↓ 13 ↔ 7 cm

ART. 47275 P T
↓ 13 ↔ 7 cm

ART. 47276 R
↓ 13 ↔ 7 cm

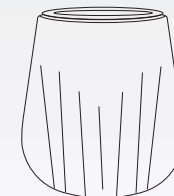

ART. 49312 P
↓ 17,5 ↔ 16,5 cm

ART. 49313 R
↓ 17,5 ↔ 16,5 cm

ART. 49212 P T
↓ 17,5 ↔ 16,5 cm

ART. 49213 R
↓ 17,5 ↔ 16,5 cm



ART. 46312 Ø 5 P
↓ 20 ↔ 9 cm

ART. 46012 Ø 5 T
↓ 20 ↔ 9 cm

ART. 46315 Ø 4 P
↓ 13,5 ↔ 7 cm

ART. 46016 Ø 4 T
↓ 13,5 ↔ 7 cm

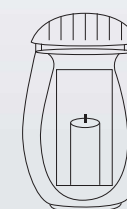

ART. 46948 P
↓ 19 ↔ 13,5 cm

ART. 46695 T
↓ 19 ↔ 13,5 cm

Per ordinazioni aggiungere al codice articolo la sigla corrispondente alla colorazione scelta,
To place orders add to the article code the letter corresponding the selected colouring.

Per ordinazioni aggiungere al codice articolo la sigla corrispondente alla colorazione scelta,
To place orders add to the article code the letter corresponding the selected colouring.

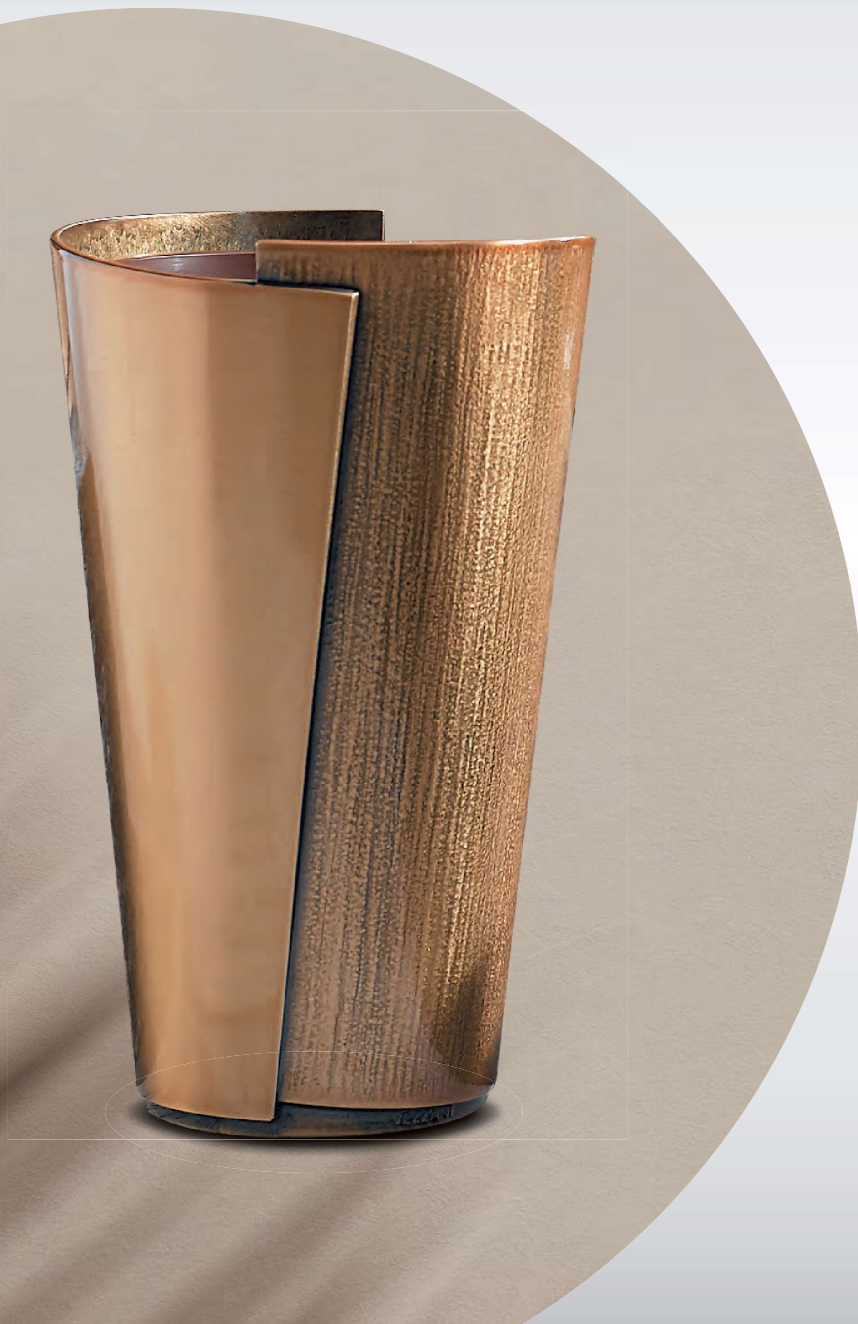

ART. 47305 P
↓ 20 ↔ 12 cm

ART. 47105 P T
↓ 20 ↔ 12 cm

ART. 47306 R
↓ 20 ↔ 12 cm

ART. 47106 R
↓ 20 ↔ 12 cm



ART. 49365 P
↓ 18 ↔ 18 cm

ART. 49165 P T
↓ 18 ↔ 18 cm

ART. 49366 R
↓ 18 ↔ 18 cm

ART. 49166 R
↓ 18 ↔ 18 cm



ART. 46305 Ø 5 P
↓ 19 ↔ 8,5 cm

ART. 46105 Ø 5 T
↓ 19 ↔ 8,5 cm



ART. 46991 4gg P
↓ 18 ↔ 13 cm

ART. 46901 4gg T
↓ 18 ↔ 13 cm



ART. 40102 8x10 cm
ART. 40100 9x12 cm
ART. 40101 11x15 cm
ART. 40103 13x18 cm
ART. 40104 18x24 cm



ART. 40119 8x10 cm
ART. 40120 9x12 cm
ART. 40122 10x15 cm
ART. 40121 11x15 cm
ART. 40124 13x18 cm
ART. 40123 18x24 cm

Finitura lucida

Finitura opaca



ART. 47305 P $\updownarrow 20 \leftrightarrow 12$ cm
 ART. 47306 R $\updownarrow 20 \leftrightarrow 12$ cm
 ART. 47105 P $\updownarrow 20 \leftrightarrow 12$ cm
 ART. 47106 R $\updownarrow 20 \leftrightarrow 12$ cm

ART. 46991 4gg $\updownarrow 18 \leftrightarrow 13$ cm
 ART. 46901 4gg $\updownarrow 18 \leftrightarrow 13$ cm

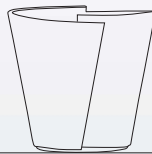

ART. 46305 Ø 5 P $\updownarrow 19 \leftrightarrow 8,5$ cm
 ART. 46105 Ø 5 T $\updownarrow 19 \leftrightarrow 8,5$ cm
 ART. 49365 P $\updownarrow 18 \leftrightarrow 18$ cm
 ART. 49165 P $\updownarrow 18 \leftrightarrow 18$ cm
 ART. 49366 R $\updownarrow 18 \leftrightarrow 18$ cm
 ART. 49166 R $\updownarrow 18 \leftrightarrow 18$ cm



Per ordinazioni aggiungere al codice articolo la sigla corrispondente alla colorazione scelta.
 To place orders add to the article code the letter corresponding to the selected colouring.

Per ordinazioni aggiungere al codice articolo la sigla corrispondente alla colorazione scelta.
 To place orders add to the article code the letter corresponding to the selected colouring.



ART. 47019 P T
↓ 28 ↔ 17 cm



ART. 47515 P P
↓ 20 ↔ 12 cm
ART. 47514 R
↓ 20 ↔ 12 cm
ART. 47503 P
↓ 12 ↔ 7 cm
ART. 47502 R
↓ 12 ↔ 7 cm



ART. 47015 P T
↓ 20 ↔ 12 cm
ART. 47014 R
↓ 20 ↔ 12 cm
ART. 47013 P
↓ 12 ↔ 7 cm
ART. 47012 R
↓ 12 ↔ 7 cm



ART. 49515 P P
↓ 18 ↔ 17 cm
ART. 49015 P T
↓ 18 ↔ 17 cm
ART. 49514 R
↓ 18 ↔ 17 cm
ART. 49014 R
↓ 18 ↔ 17 cm
ART. 46018 Ø6 T
↓ 26 ↔ 14 cm



ART. 46515 Ø5 P
↓ 19 ↔ 9 cm
ART. 46502 Ø4
↓ 14 ↔ 7 cm



ART. 46015 Ø5 T
↓ 19 ↔ 9 cm
ART. 46013 Ø4
↓ 14 ↔ 7 cm



ART. 46943 P
↓ 21 ↔ 13 cm
ART. 46843 T
↓ 21 ↔ 13 cm



ART. 46844 T
↓ 27 ↔ 15 cm



ART. 46960 P
↓ 21 ↔ 13 cm
ART. 46762 T
↓ 21 ↔ 13 cm

ART. 46760 T
↓ 23 ↔ 13 cm



ART. 47021 P T
↓ 28 ↔ 17 cm
ART. 47020 R
↓ 28 ↔ 17 cm



ART. 47517 P P
↓ 20 ↔ 12 cm
ART. 47516 R
↓ 20 ↔ 12 cm
ART. 47546 P
↓ 12 ↔ 7 cm
ART. 47543 R
↓ 12 ↔ 7 cm



ART. 47017 P T
↓ 20 ↔ 12 cm
ART. 47016 R
↓ 20 ↔ 12 cm
ART. 47046 P
↓ 12 ↔ 7 cm
ART. 47043 R
↓ 12 ↔ 7 cm



ART. 49517 P P
↓ 18 ↔ 17 cm
ART. 49516 R
↓ 18 ↔ 17 cm



ART. 49017 P T
↓ 18 ↔ 17 cm
ART. 49016 R
↓ 18 ↔ 17 cm
ART. 46020 Ø6 T
↓ 24 ↔ 14 cm
ART. 46517 Ø5 P
↓ 19 ↔ 9 cm
ART. 46543 Ø4
↓ 14 ↔ 7 cm
ART. 46017 Ø5 T
↓ 19 ↔ 9 cm
ART. 46043 Ø4
↓ 14 ↔ 7 cm

Finitura lucida

Finitura opaco



ART. 47019 P **T**
 ↓ 28 ↔ 17 cm

ART. 47018 R
 ↓ 28 ↔ 17 cm

ART. 46515 Ø 5 **P**
 ↓ 19 ↔ 9 cm

ART. 46015 Ø 5 **T**
 ↓ 19 ↔ 9 cm

ART. 46502 Ø 4
 ↓ 14 ↔ 7 cm

ART. 46013 Ø 4 **T**
 ↓ 14 ↔ 7 cm

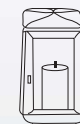

ART. 47515 P **P**
 ↓ 20 ↔ 12 cm

ART. 47514 R
 ↓ 20 ↔ 12 cm

ART. 47503 P
 ↓ 12 ↔ 7 cm

ART. 47502 R
 ↓ 12 ↔ 7 cm

ART. 47015 P **T**
 ↓ 20 ↔ 12 cm

ART. 47014 R
 ↓ 20 ↔ 12 cm

ART. 47013 P
 ↓ 12 ↔ 7 cm

ART. 47012 R
 ↓ 12 ↔ 7 cm

ART. 49515 P **P**
 ↓ 18 ↔ 17 cm

ART. 49514 R
 ↓ 18 ↔ 17 cm

ART. 49015 P **T**
 ↓ 18 ↔ 17 cm

ART. 49014 R
 ↓ 18 ↔ 17 cm

ART. 46018 Ø 6 **T**
 ↓ 26 ↔ 14 cm

ART. 46844 P **T**
 ↓ 27 ↔ 15 cm

ART. 46943 **P**
 ↓ 21 ↔ 13 cm

ART. 46843 **T**
 ↓ 21 ↔ 13 cm



VEL VERDE LUCIDO

BIL BIANCO LUCIDO

BLL BLU LUCIDO

VIL VIOLA LUCIDO

ROL ROSSO LUCIDO

TOL TORTORA LUCIDO

BEL BEIGE LUCIDO

AZL AZZURRO LUCIDO

STL SATÈN LUCIDO



VEO VERDE OPACO

BIO BIANCO OPACO

BLO BLU OPACO

VIO VIOLA OPACO

ROO ROSSO OPACO

TOO TORTORA OPACO

BEO BEIGE OPACO

AZO AZZURRO OPACO

STO SATÈN OPACO

Per ordinazioni aggiungere al codice articolo la sigla corrispondente alla colorazione scelta,
 To place orders add to the article code the letter corresponding to the selected colouring.

Per ordinazioni aggiungere al codice articolo la sigla corrispondente alla colorazione scelta,
 To place orders add to the article code the letter corresponding to the selected colouring.

NOVITÀ



ART. 47019MO P T
↓ 28 ↔ 17 cm

ART. 47018MO R
↓ 28 ↔ 17 cm



ART. 47515MO P P
↓ 20 ↔ 12 cm

ART. 47514MO R
↓ 20 ↔ 12 cm

ART. 47503MO P
↓ 12 ↔ 7 cm

ART. 47502MO R
↓ 12 ↔ 7 cm



ART. 49515MO P P
↓ 18 ↔ 17 cm

ART. 49514MO R
↓ 18 ↔ 17 cm

ART. 49015MO P T
↓ 18 ↔ 17 cm

ART. 49014MO R
↓ 18 ↔ 17 cm



ART. 46018MO Ø6 T
↓ 26 ↔ 14 cm



ART. 46515MO Ø5 P
↓ 19 ↔ 9 cm

ART. 46502MO Ø4
↓ 14 ↔ 7 cm

ART. 46015MO Ø5 T
↓ 19 ↔ 9 cm

ART. 46013MO Ø4
↓ 14 ↔ 7 cm



ART. 46960MO P
↓ 21 ↔ 13 cm

ART. 46762MO T
↓ 21 ↔ 13 cm



ART. 46760MO T
↓ 23 ↔ 13 cm



ART. 31633MO 7x9 cm
ART. 31663MO 8x10 cm
ART. 40106MO 9x12 cm
ART. 40107MO 11x15 cm
ART. 31664MO 13x18 cm



ART. 31635MO 7x9 cm
ART. 31636MO 8x10 cm
ART. 40126MO 9x12 cm
ART. 40127MO 10x15 cm
ART. 40128MO 11x15 cm
ART. 40139MO 13x18 cm



ART. 41136MO ↓ 15 ↔ 6,5 cm
ART. 41137MO ↓ 20 ↔ 9 cm
ART. 41138MO ↓ 25 ↔ 11 cm
ART. 41139MO ↓ 30 ↔ 13 cm
ART. 41140MO ↓ 40 ↔ 18 cm
ART. 41141MO ↓ 50 ↔ 21,5 cm



| | | | | | | |
|------------------------------|------------------------------|------------------------------|-----------------------------|-------------------------------|------------------------------|------------------------------|
| ART. 47208 P ↓ 28 ↔ 16 cm | ART. 47337 P ↓ 21 ↔ 13 cm | ART. 47237 P ↓ 21 ↔ 13 cm | ART. 47331 P ↓ 13 ↔ 7 cm | ART. 47259 P ↓ 13 ↔ 7,5 cm | ART. 49337 P ↓ 20 ↔ 17 cm | ART. 49237 P ↓ 20 ↔ 17 cm |
| ART. 47209 R ↓ 28 ↔ 16 cm | ART. 47338 R ↓ 21 ↔ 13 cm | ART. 47238 R ↓ 21 ↔ 13 cm | ART. 47332 R ↓ 13 ↔ 7 cm | ART. 47260 R ↓ 13 ↔ 7,5 cm | ART. 49338 R ↓ 20 ↔ 17 cm | ART. 49238 R ↓ 20 ↔ 17 cm |



| | | | |
|-----------------------------------|-------------------------------|----------------------------|----------------------------|
| ART. 46331 Ø 4 ↓ 13,5 ↔ 7,5 cm | ART. 46337 Ø 5 ↓ 20 ↔ 9 cm | ART. 46798 ↓ 25 ↔ 14 cm | ART. 46926 ↓ 20 ↔ 14 cm |
| ART. 46259 Ø 4 ↓ 13,5 ↔ 7,5 cm | ART. 46237 Ø 5 ↓ 20 ↔ 9 cm | | ART. 46797 ↓ 20 ↔ 14 cm |



| | | | |
|------------------------------|---------------------|---------------------|---------------------------|
| ART. 46919 P ↓ 17 ↔ 12 cm | ART. 31633 7x9 cm | ART. 31635 7x9 cm | ART. 41136 ↓ 15 ↔ 6,5 cm |
| ART. 46795 T ↓ 17 ↔ 12 cm | ART. 31663 8x10 cm | ART. 31636 8x10 cm | ART. 41137 ↓ 20 ↔ 9 cm |
| | ART. 40106 9x12 cm | ART. 40126 9x12 cm | ART. 41138 ↓ 25 ↔ 11 cm |
| | ART. 40107 11x15 cm | ART. 40127 10x15 cm | ART. 41139 ↓ 30 ↔ 13 cm |
| | ART. 31664 13x18 cm | ART. 40128 11x15 cm | ART. 41140 ↓ 40 ↔ 18 cm |
| | | ART. 40139 13x18 cm | ART. 41141 ↓ 50 ↔ 21,5 cm |

NOVITÀ



ART. 47208DU P
↓ 28 ↔ 16 cm

ART. 47209DU R
↓ 28 ↔ 16 cm



ART. 47337DU P
↓ 21 ↔ 13 cm

ART. 47338DU R
↓ 21 ↔ 13 cm



ART. 47331DU P
↓ 13 ↔ 7 cm

ART. 47332DU R
↓ 13 ↔ 7 cm



ART. 49337DU P
↓ 20 ↔ 17 cm

ART. 49338DU R
↓ 20 ↔ 17 cm

ART. 47237DU P
↓ 21 ↔ 13 cm

ART. 47238DU R
↓ 21 ↔ 13 cm

ART. 47259DU P
↓ 13 ↔ 7,5 cm

ART. 47260DU R
↓ 13 ↔ 7,5 cm

ART. 49237DU P
↓ 20 ↔ 17 cm

ART. 49238DU R
↓ 20 ↔ 17 cm



ART. 46331DU Ø 4
↓ 13,5 ↔ 7,5 cm

ART. 46259DU Ø 4
↓ 13,5 ↔ 7,5 cm



ART. 46337DU Ø 5
↓ 20 ↔ 9 cm

ART. 46237DU Ø 5
↓ 20 ↔ 9 cm



ART. 46798DU
↓ 25 ↔ 14 cm



ART. 46926DU
↓ 20 ↔ 14 cm



ART. 46919DU
↓ 17 ↔ 12 cm

ART. 46797DU
↓ 20 ↔ 14 cm

ART. 46795DU
↓ 17 ↔ 12 cm



ART. 31633DU 7x9 cm
ART. 31663DU 8x10 cm
ART. 40106DU 9x12 cm
ART. 40107DU 11x15 cm
ART. 31664DU 13x18 cm



ART. 31635DU 7x9 cm
ART. 31636DU 8x10 cm
ART. 40126DU 9x12 cm
ART. 40127DU 10x15 cm
ART. 40128DU 11x15 cm
ART. 40139DU 13x18 cm



ART. 41136DU ↓ 15 ↔ 6,5 cm
ART. 41137DU ↓ 20 ↔ 9 cm
ART. 41138DU ↓ 25 ↔ 11 cm
ART. 41139DU ↓ 30 ↔ 13 cm
ART. 41140DU ↓ 40 ↔ 18 cm
ART. 41141DU ↓ 50 ↔ 21,5 cm



ART. 47647 P
↓ 28 ↔ 17 cm

ART. 47147 P T
↓ 28 ↔ 17 cm

ART. 47648 R
↓ 28 ↔ 17 cm

ART. 47148 R
↓ 28 ↔ 17 cm



ART. 47646 P
↓ 20 ↔ 13 cm

ART. 47146 P T
↓ 20 ↔ 13 cm

ART. 47645 R
↓ 20 ↔ 13 cm

ART. 47145 R
↓ 20 ↔ 13 cm



ART. 47655 P
↓ 13 ↔ 7 cm

ART. 47155 P T
↓ 13 ↔ 7 cm

ART. 47654 R
↓ 13 ↔ 7 cm

ART. 47154 R
↓ 13 ↔ 7 cm



ART. 49657 P
↓ 19 ↔ 17 cm

ART. 49157 P T
↓ 19 ↔ 17 cm

ART. 49656 R
↓ 19 ↔ 17 cm

ART. 49156 R
↓ 19 ↔ 17 cm



ART. 46647 Ø 6
↓ 27 ↔ 13 cm

ART. 46147 Ø 6
↓ 27 ↔ 13 cm



ART. 46645 Ø 5
↓ 19 ↔ 9,5 cm

ART. 46145 Ø 5
↓ 19 ↔ 9,5 cm



ART. 46654 Ø 4
↓ 13 ↔ 7 cm

ART. 46154 Ø 4
↓ 13 ↔ 7 cm



ART. 49662 P
↓ 16 ↔ 19 cm

ART. 49663 R
↓ 16 ↔ 19 cm



ART. 49507 P
↓ 11,5 ↔ 37,5 cm



ART. 46653 Ø 5
↓ 19 ↔ 10 cm



ART. 46930 P
↓ 18 ↔ 13 cm

ART. 46830 T
↓ 18 ↔ 13 cm

ART. 46831
↓ 22 ↔ 17 cm



ART. 46825 T
↓ 27 ↔ 15 cm



ART. 47469 P T
↓ 8 ↔ 17 cm

ART. 47468 R
↓ 8 ↔ 17 cm



ART. 46895 T
Ø 5 ↓ 16 ↔ 9 cm

NOVITÀ



ART. 47647DU P
↓ 28 ↔ 17 cm



ART. 47147DU P T
↓ 28 ↔ 17 cm



ART. 47646DU P P
↓ 20 ↔ 13 cm



ART. 47146DU P T
↓ 20 ↔ 13 cm



ART. 47655DU P P
↓ 13 ↔ 7 cm



ART. 47155DU P T
↓ 13 ↔ 7 cm



ART. 47648DU R
↓ 28 ↔ 17 cm



ART. 47148DU R
↓ 28 ↔ 17 cm



ART. 47645DU R
↓ 20 ↔ 13 cm



ART. 47145DU R
↓ 20 ↔ 13 cm



ART. 47654DU R
↓ 13 ↔ 7 cm



ART. 47154DU R
↓ 13 ↔ 7 cm



ART. 49657DU P P
↓ 19 ↔ 17 cm



ART. 49157DU P T
↓ 19 ↔ 17 cm



ART. 46647DU Ø 6 P
↓ 27 ↔ 13 cm



ART. 46645DU Ø 5 P
↓ 19 ↔ 9,5 cm



ART. 46654DU Ø 4 P
↓ 13 ↔ 7 cm



ART. 49656DU R
↓ 19 ↔ 17 cm



ART. 49156DU R
↓ 19 ↔ 17 cm



ART. 46147DU Ø 6 T
↓ 27 ↔ 13 cm



ART. 46145DU Ø 5 T
↓ 19 ↔ 9,5 cm



ART. 46154DU Ø 4 T
↓ 13 ↔ 7 cm



ART. 49662DU P P
↓ 16 ↔ 19 cm



ART. 49663DU R
↓ 16 ↔ 19 cm



ART. 46653DU Ø 5 P
↓ 19 ↔ 10 cm



ART. 46930DU P
↓ 18 ↔ 13 cm



ART. 46830DU T
↓ 18 ↔ 13 cm



ART. 46831DU
↓ 22 ↔ 17 cm



ART. 46825DU T
↓ 27 ↔ 15 cm



ART. 47469DU P T
↓ 8 ↔ 17 cm



ART. 47468DU R
↓ 8 ↔ 17 cm



ART. 46895DU T
Ø 5 ↓ 16 ↔ 9 cm





ART. 47566 P
↓ 28 ↔ 17 cm

ART. 47199 P
↓ 28 ↔ 17 cm



ART. 47564 P
↓ 20 ↔ 13 cm
ART. 47558 R
↓ 20 ↔ 13 cm



ART. 47561 P
↓ 13 ↔ 7 cm

ART. 47157 P
↓ 13 ↔ 7 cm



ART. 49659 P
↓ 20 ↔ 13 cm

ART. 49159 P
↓ 20 ↔ 13 cm



ART. 46598 Ø 6
↓ 27 ↔ 13 cm

ART. 46198 Ø 6
↓ 27 ↔ 13 cm



ART. 46558 Ø 5
↓ 19 ↔ 9,5 cm

ART. 46158 Ø 5
↓ 19 ↔ 9,5 cm



ART. 46557 Ø 4
↓ 13 ↔ 7 cm

ART. 46156 Ø 4
↓ 13 ↔ 7 cm



ART. 49660 P
↓ 16 ↔ 19 cm

ART. 49661 R
↓ 16 ↔ 19 cm



ART. 49509 P
↓ 11,5 ↔ 37,5 cm



ART. 46652 Ø 5
↓ 19 ↔ 10 cm



ART. 46998
↓ 18 ↔ 13 cm

ART. 46898
↓ 18 ↔ 13 cm

ART. 46899
↓ 22 ↔ 17 cm



ART. 46700
↓ 27 ↔ 15 cm



ART. 47471 P
↓ 8 ↔ 17 cm
ART. 47470 R
↓ 8 ↔ 17 cm



ART. 46701
Ø 5 ↓ 16 ↔ 9 cm



ART. 47472 R
↓ 13 ↔ 17 cm
ART. 47473 P
↓ 13 ↔ 17 cm



ART. 46702
↓ 13 ↔ 17 cm

primaria lega patinata carrara

primaria lega patinata botticino



ART. 47647CA P
↓ 28 ↔ 17 cm
ART. 47648CA R
↓ 28 ↔ 17 cm
ART. 47147CA P
↓ 28 ↔ 17 cm
ART. 47148CA R
↓ 28 ↔ 17 cm

ART. 47647BO P
↓ 28 ↔ 17 cm
ART. 47648BO R
↓ 28 ↔ 17 cm
ART. 47147BO P
↓ 28 ↔ 17 cm
ART. 47148BO R
↓ 28 ↔ 17 cm



ART. 47646CA P
↓ 20 ↔ 13 cm
ART. 47645CA R
↓ 20 ↔ 13 cm
ART. 47146CA P
↓ 20 ↔ 13 cm
ART. 47145CA R
↓ 20 ↔ 13 cm

ART. 47655CA P
↓ 13 ↔ 7 cm
ART. 47654CA R
↓ 13 ↔ 7 cm
ART. 47155CA P
↓ 13 ↔ 7 cm
ART. 47154CA R
↓ 13 ↔ 7 cm

ART. 47655BO P
↓ 13 ↔ 7 cm
ART. 47654BO R
↓ 13 ↔ 7 cm
ART. 47155BO P
↓ 13 ↔ 7 cm
ART. 47154BO R
↓ 13 ↔ 7 cm

ART. 47646BO P
↓ 20 ↔ 13 cm
ART. 47645BO R
↓ 20 ↔ 13 cm
ART. 47146BO P
↓ 20 ↔ 13 cm
ART. 47145BO R
↓ 20 ↔ 13 cm



ART. 49657CA P
↓ 19 ↔ 17 cm
ART. 49656CA R
↓ 19 ↔ 17 cm
ART. 49157CA P
↓ 19 ↔ 17 cm
ART. 49156CA R
↓ 19 ↔ 17 cm

ART. 49662CA P
↓ 16 ↔ 19 cm
ART. 49663CA R
↓ 16 ↔ 19 cm

ART. 47469CA P
↓ 8 ↔ 17 cm
ART. 47468CA R
↓ 8 ↔ 17 cm

ART. 47469BO P
↓ 8 ↔ 17 cm
ART. 47468BO R
↓ 8 ↔ 17 cm

ART. 49662BO P
↓ 16 ↔ 19 cm
ART. 49663BO R
↓ 16 ↔ 19 cm

ART. 49657BO P
↓ 19 ↔ 17 cm
ART. 49656BO R
↓ 19 ↔ 17 cm
ART. 49157BO P
↓ 19 ↔ 17 cm
ART. 49156BO R
↓ 19 ↔ 17 cm



ART. 46647CA P
Ø 6 ↓ 27 ↔ 13 cm

ART. 46645CA P
Ø 5 ↓ 19 ↔ 9,5 cm

ART. 46654CA P
Ø 4 ↓ 13 ↔ 7 cm

ART. 46653CA P
Ø 5 ↓ 19 ↔ 10 cm

ART. 46895CA T
Ø 5 ↓ 16 ↔ 9 cm

ART. 46895BO T
Ø 5 ↓ 16 ↔ 9 cm

ART. 46653BO P
Ø 5 ↓ 19 ↔ 10 cm

ART. 46654BO P
Ø 4 ↓ 13 ↔ 7 cm

ART. 46645BO P
Ø 5 ↓ 19 ↔ 9,5 cm

ART. 46647BO P
Ø 6 ↓ 27 ↔ 13 cm

ART. 46147CA T
Ø 6 ↓ 27 ↔ 13 cm

ART. 46145CA T
Ø 5 ↓ 19 ↔ 9,5 cm

ART. 46154CA T
Ø 4 ↓ 13 ↔ 7 cm

ART. 46154BO T
Ø 4 ↓ 13 ↔ 7 cm

ART. 46145BO T
Ø 5 ↓ 19 ↔ 9,5 cm

ART. 46147BO T
Ø 6 ↓ 27 ↔ 13 cm



ART. 46930CA 4GG P
↓ 18 ↔ 13 cm
ART. 46830CA 4GG T
↓ 18 ↔ 13 cm
ART. 46831CA 6GG T
↓ 22 ↔ 17 cm

ART. 46960CA 4GG P
↓ 21 ↔ 13 cm
ART. 46762CA 4GG T
↓ 21 ↔ 13 cm
ART. 46825CA 8GG T
↓ 27 ↔ 15 cm

ART. 47467CA P T
↓ 13 ↔ 17 cm
ART. 47466CA R T
↓ 13 ↔ 17 cm

ART. 47467BO P T
↓ 13 ↔ 17 cm
ART. 47466BO R T
↓ 13 ↔ 17 cm

ART. 46960BO 4GG P
↓ 21 ↔ 13 cm
ART. 46762BO 4GG T
↓ 21 ↔ 13 cm
ART. 46825BO 8GG T
↓ 27 ↔ 15 cm

ART. 46930BO 4GG P
↓ 18 ↔ 13 cm
ART. 46830BO 4GG T
↓ 18 ↔ 13 cm
ART. 46831BO 6GG T
↓ 22 ↔ 17 cm



ART. 47215 P T
↓ 28 ↔ 18 cm

ART. 47216 R
↓ 28 ↔ 18 cm



ART. 47319 P P
↓ 20 ↔ 12 cm

ART. 47320 R
↓ 20 ↔ 12 cm

ART. 47219 P T
↓ 20 ↔ 12 cm

ART. 47220 R
↓ 20 ↔ 12 cm



ART. 49319 P P
↓ 17 ↔ 17 cm

ART. 49320 R
↓ 17 ↔ 17 cm

ART. 49219 P T
↓ 17 ↔ 17 cm

ART. 49220 R
↓ 17 ↔ 17 cm



ART. 46765 T
↓ 25 ↔ 16 cm



ART. 46959 P
↓ 19 ↔ 13,5 cm

ART. 46759 T
↓ 19 ↔ 13,5 cm



ART. 46319 Ø5 P
↓ 20 ↔ 8,5 cm

ART. 46219 Ø5 T
↓ 20 ↔ 8,5 cm



ART. 47217 P T
↓ 28 ↔ 18 cm

ART. 47218 R
↓ 28 ↔ 18 cm



ART. 47321 P P
↓ 20 ↔ 12 cm

ART. 47322 R
↓ 20 ↔ 12 cm

ART. 47221 P T
↓ 20 ↔ 12 cm

ART. 47222 R
↓ 20 ↔ 12 cm



ART. 49321 P P
↓ 17 ↔ 17 cm

ART. 49322 R
↓ 17 ↔ 17 cm

ART. 49221 P T
↓ 17 ↔ 17 cm

ART. 49222 R
↓ 17 ↔ 17 cm



ART. 46767 T
↓ 25 ↔ 16 cm



ART. 46966 P
↓ 19 ↔ 13,5 cm

ART. 46766 T
↓ 19 ↔ 13,5 cm



ART. 46321 Ø5 P
↓ 20 ↔ 8,5 cm

ART. 46221 Ø5 T
↓ 20 ↔ 8,5 cm



ART. 47055 P
↓ 28 ↔ 17 cm

ART. 47053 R
↓ 28 ↔ 17 cm



ART. 47550 P
↓ 19 ↔ 10,5 cm
ART. 47551 R
↓ 19 ↔ 10,5 cm
ART. 47678 P
↓ 12 ↔ 7 cm
ART. 47689 R
↓ 12 ↔ 7 cm

ART. 47050 P
↓ 19 ↔ 10,5 cm
ART. 47051 R
↓ 19 ↔ 10,5 cm
ART. 47178 P
↓ 12 ↔ 7 cm
ART. 47189 R
↓ 12 ↔ 7 cm



ART. 49560 P
↓ 17 ↔ 17 cm
ART. 49060 P
↓ 17 ↔ 17 cm
ART. 49561 R
↓ 17 ↔ 17 cm
ART. 49061 R
↓ 17 ↔ 17 cm



ART. 46560 Ø5
↓ 19 ↔ 8 cm
ART. 46678 Ø4
↓ 13 ↔ 7 cm

ART. 46060 Ø5
↓ 19 ↔ 8 cm
ART. 46178 Ø4
↓ 13 ↔ 7 cm



ART. 49562 P
↓ 18 ↔ 18,5 cm



ART. 46562 Ø5
↓ 18 ↔ 11,5 cm



ART. 46930 P
↓ 18 ↔ 13 cm
ART. 46830
↓ 18 ↔ 13 cm
ART. 46831
↓ 22 ↔ 17 cm



ART. 47152 P
↓ 28 ↔ 17 cm
ART. 47149 R
↓ 28 ↔ 17 cm



ART. 47650 P
↓ 19 ↔ 10,5 cm
ART. 47651 R
↓ 19 ↔ 10,5 cm
ART. 47676 P
↓ 12 ↔ 7 cm
ART. 47677 R
↓ 12 ↔ 7 cm

ART. 47150 P
↓ 19 ↔ 10,5 cm
ART. 47151 R
↓ 19 ↔ 10,5 cm
ART. 47176 P
↓ 12 ↔ 7 cm
ART. 47177 R
↓ 12 ↔ 7 cm



ART. 49654 P
↓ 17 ↔ 17 cm
ART. 49154 P
↓ 17 ↔ 17 cm
ART. 49655 R
↓ 17 ↔ 17 cm
ART. 49155 R
↓ 17 ↔ 17 cm



ART. 49564 P
↓ 18 ↔ 18,5 cm



ART. 46564 Ø5
↓ 18 ↔ 11,5 cm



ART. 46650 Ø5
↓ 19 ↔ 8 cm
ART. 46676 Ø4
↓ 13 ↔ 7 cm

ART. 46150 Ø5
↓ 19 ↔ 8 cm
ART. 46176 Ø4
↓ 13 ↔ 7 cm



ART. 47213 P **T**
↓ 28 ↔ 17 cm

ART. 47212 R
↓ 28 ↔ 17 cm



ART. 47310 P **P**
↓ 20 ↔ 12 cm

ART. 47311 R
↓ 20 ↔ 12 cm

ART. 47210 P **T**
↓ 20 ↔ 12 cm

ART. 47211 R
↓ 20 ↔ 12 cm



ART. 49310 P **P**
↓ 18 ↔ 17 cm

ART. 49311 R
↓ 18 ↔ 17 cm

ART. 49210 P **T**
↓ 18 ↔ 17 cm

ART. 49211 R
↓ 18 ↔ 17 cm



ART. 46212 Ø6 **T**
↓ 26 ↔ 14 cm



ART. 46310 Ø5 **P**
↓ 19 ↔ 10 cm

ART. 46210 Ø5 **T**
↓ 19 ↔ 10 cm



ART. 46952 **P**
↓ 18 ↔ 13 cm

ART. 46756 **T**
↓ 18 ↔ 13 cm

ART. 46757
↓ 22 ↔ 17 cm



ART. 46960 **P**
↓ 21 ↔ 13 cm

ART. 46762 **T**
↓ 21 ↔ 13 cm



ART. 46760 **T**
↓ 23 ↔ 13 cm



ART. 31633 7x9 cm
ART. 31663 8x10 cm
ART. 40106 9x12 cm
ART. 40107 11x15 cm
ART. 31664 13x18 cm

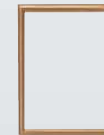

ART. 31635 7x9 cm
ART. 31636 8x10 cm
ART. 40126 9x12 cm
ART. 40127 10x15 cm
ART. 40128 11x15 cm
ART. 40139 13x18 cm



ART. 41136 ↓ 15 ↔ 6,5 cm
ART. 41137 ↓ 20 ↔ 9 cm
ART. 41138 ↓ 25 ↔ 11 cm
ART. 41139 ↓ 30 ↔ 13 cm
ART. 41140 ↓ 40 ↔ 18 cm
ART. 41141 ↓ 50 ↔ 21,5 cm



ART. 47081 P
↓ 28 ↔ 14 cm



ART. 47577 P
↓ 20 ↔ 9 cm



ART. 47077 P
↓ 20 ↔ 9 cm



ART. 49590 P
↓ 19 ↔ 11,5 cm



ART. 49573 P
↓ 17,5 ↔ 15,5 cm

ART. 49073 P
↓ 17,5 ↔ 15,5 cm

ART. 47101 R
↓ 28 ↔ 14 cm

ART. 47578 R
↓ 20 ↔ 9 cm

ART. 47078 R
↓ 20 ↔ 9 cm

ART. 49574 R
↓ 17,5 ↔ 15,5 cm

ART. 49074 R
↓ 17,5 ↔ 15,5 cm



ART. 46081 Ø6
↓ 24 ↔ 12 cm



ART. 46577 Ø5
↓ 20 ↔ 9 cm



ART. 46077 Ø5
↓ 20 ↔ 9 cm



ART. 46946 P
↓ 18 ↔ 13 cm

ART. 46846 T
↓ 18 ↔ 13 cm



PORTAORCHIDEA
con biadesivo
ART. 47637 P

↓ 12 ↔ 5 cm

ART. 46847
↓ 22 ↔ 17 cm



ART. 35200 9x12 cm
ART. 35210 11x15 cm



ART. 35230 9x12 cm
ART. 35240 10x15 cm
ART. 35250 11x15 cm



ART. 31633 7x9 cm
ART. 31663 8x10 cm
ART. 40106 9x12 cm
ART. 40107 11x15 cm
ART. 31664 13x18 cm

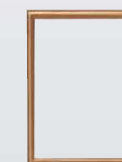

ART. 31635 7x9 cm
ART. 31636 8x10 cm
ART. 40126 9x12 cm
ART. 40127 10x15 cm
ART. 40128 11x15 cm
ART. 40139 13x18 cm



ART. 41136 ↓ 15 ↔ 6,5 cm
ART. 41137 ↓ 20 ↔ 9 cm
ART. 41138 ↓ 25 ↔ 11 cm
ART. 41139 ↓ 30 ↔ 13 cm
ART. 41140 ↓ 40 ↔ 18 cm
ART. 41141 ↓ 50 ↔ 21,5 cm



ART. 47693 P
↓ 28 ↔ 18 cm

ART. 47193 P T
↓ 28 ↔ 18 cm



ART. 47691 P
↓ 20 ↔ 13 cm

ART. 47191 P T
↓ 20 ↔ 13 cm



ART. 49691 P
↓ 18 ↔ 17 cm

ART. 49191 P T
↓ 18 ↔ 17 cm

ART. 47692 R
↓ 28 ↔ 18 cm

ART. 47192 R
↓ 28 ↔ 18 cm

ART. 47690 R
↓ 20 ↔ 13 cm

ART. 47190 R
↓ 20 ↔ 13 cm

ART. 49690 R
↓ 18 ↔ 17 cm

ART. 49190 R
↓ 20 ↔ 10 cm



ART. 46930 P
↓ 18 ↔ 13 cm

ART. 46830 T
↓ 18 ↔ 13 cm



ART. 46690 Ø 5
↓ 20 ↔ 9 cm

ART. 46190 Ø 5 T
↓ 20 ↔ 9 cm



ART. 41136 ↓ 15 ↔ 6,5 cm
ART. 41137 ↓ 20 ↔ 9 cm
ART. 41138 ↓ 25 ↔ 11 cm
ART. 41139 ↓ 30 ↔ 13 cm
ART. 41140 ↓ 40 ↔ 18 cm
ART. 41141 ↓ 50 ↔ 21,5 cm

ART. 46691 Ø 6
↓ 23 ↔ 10 cm

ART. 46831
↓ 22 ↔ 17 cm

ART. 46191 Ø 6
↓ 23 ↔ 10 cm

ART. 46191 Ø 6
↓ 23 ↔ 10 cm



ART. 31633 7x9 cm
ART. 31663 8x10 cm
ART. 40106 9x12 cm
ART. 40107 11x15 cm
ART. 31664 13x18 cm

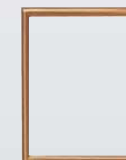

ART. 31635 7x9 cm
ART. 31636 8x10 cm
ART. 40126 9x12 cm
ART. 40127 10x15 cm
ART. 40128 11x15 cm
ART. 40139 13x18 cm



ART. 35200 9x12 cm
ART. 35210 11x15 cm



ART. 35230 9x12 cm
ART. 35240 10x15 cm
ART. 35250 11x15 cm



ART. 47530 R **P**
↓ 28 ↔ 14 cm



ART. 47526 R **P**
↓ 20 ↔ 10 cm



ART. 47508 P **P**
↓ 13 ↔ 6 cm



ART. 49526 R **P**
↓ 17 ↔ 14 cm

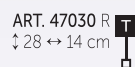

ART. 47030 R **T**
↓ 28 ↔ 14 cm

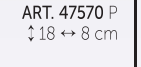

ART. 47570 P
↓ 18 ↔ 8 cm

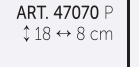

ART. 47070 P
↓ 18 ↔ 8 cm

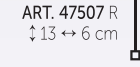

ART. 47507 R
↓ 13 ↔ 6 cm

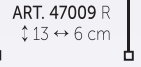

ART. 47009 R
↓ 13 ↔ 6 cm

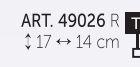

ART. 49026 R **T**
↓ 17 ↔ 14 cm

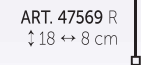

ART. 47569 R
↓ 18 ↔ 8 cm

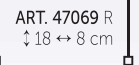

ART. 47069 R
↓ 18 ↔ 8 cm



ART. 46533 Ø 6 **P**
↓ 26 ↔ 11 cm



ART. 46526 Ø 5 **P**
↓ 19 ↔ 9 cm



ART. 46508 Ø 4 **P**
↓ 13 ↔ 6 cm



ART. 41248 12x5 cm
ART. 41249 15x6 cm
ART. 41250 20x8 cm
ART. 41251 25x10 cm
ART. 41252 30x13 cm
ART. 41253 40x16 cm
ART. 41254 50x20 cm

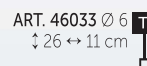

ART. 46033 Ø 6 **T**
↓ 26 ↔ 11 cm

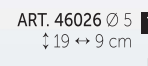

ART. 46026 Ø 5 **T**
↓ 19 ↔ 9 cm



ART. 46008 Ø 4 **T**
↓ 13 ↔ 6 cm



ART. 31660 9x12 cm
ART. 31661 11x15 cm
ART. 31662 13x18 cm



ART. 31665 9x12 cm
ART. 31666 11x15 cm
ART. 31667 13x18 cm



ART. 35197 9x12 cm
ART. 35198 11x15 cm
ART. 35199 13x18 cm



ART. 35194 9x12 cm
ART. 35195 11x15 cm
ART. 35196 13x18 cm



ART. 47538 R
↓ 28 ↔ 14 cm



ART. 47038 R
↓ 28 ↔ 14 cm



ART. 47525 R
↓ 20 ↔ 10 cm



ART. 47025 R
↓ 20 ↔ 10 cm



ART. 49536 R
↓ 17 ↔ 14 cm



ART. 49036 R
↓ 17 ↔ 14 cm



ART. 46538
Ø 6 ↓ 26 ↔ 11 cm



ART. 46525
Ø 5 ↓ 19 ↔ 9 cm



ART. 46038
Ø 6 ↓ 26 ↔ 11 cm



ART. 46025
Ø 5 ↓ 19 ↔ 9 cm



ART. 41120 12x5 cm
ART. 41121 15x6 cm
ART. 41122 20x8 cm
ART. 41123 25x10 cm



ART. 31668 9x12 cm
ART. 31669 11x15 cm
ART. 31670 13x18 cm



ART. 31671 9x12 cm
ART. 31672 11x15 cm
ART. 31673 13x18 cm



ART. 35205 9x12 cm
ART. 35206 11x15 cm
ART. 35207 13x18 cm



ART. 35202 9x12 cm
ART. 35203 11x15 cm
ART. 35204 13x18 cm



ART. 47035 P T
↓ 28 ↔ 18 cm

ART. 47036 R
↓ 28 ↔ 18 cm



ART. 47534 P P
↓ 21 ↔ 13 cm

ART. 47537 R
↓ 21 ↔ 13 cm



ART. 47034 P T
↓ 21 ↔ 13 cm

ART. 47037 R
↓ 21 ↔ 13 cm

ART. 49534 P P
↓ 18 ↔ 16 cm

ART. 49537 R
↓ 18 ↔ 16 cm

ART. 49034 P T
↓ 18 ↔ 16 cm

ART. 49037 R
↓ 18 ↔ 16 cm



ART. 46035 Ø 6 T
↓ 27 ↔ 14 cm



ART. 46534 Ø 5 P
↓ 20 ↔ 11 cm



ART. 46827 T
↓ 25 ↔ 14 cm



ART. 46924 P
↓ 20 ↔ 14 cm



ART. 46927 P
↓ 17 ↔ 12 cm

ART. 46034 Ø 5 T
↓ 20 ↔ 11 cm

ART. 46823 T
↓ 20 ↔ 14 cm

ART. 46826 T
↓ 17 ↔ 12 cm



ART. 40130 7x9 cm
ART. 40131 8x10 cm
ART. 40132 9x12 cm
ART. 40133 11x15 cm
ART. 40134 13x18 cm
ART. 40135 18x24 cm



ART. 40140 7x9 cm
ART. 40141 8x10 cm
ART. 40142 9x12 cm
ART. 40143 10x15 cm
ART. 40144 11x15 cm
ART. 40145 13x18 cm
ART. 40146 18x24 cm



ART. 35307 9x12 cm
ART. 35308 11x15 cm
ART. 35309 13x18 cm



ART. 35296 9x12 cm
ART. 35138 10x15 cm
ART. 35297 11x15 cm
ART. 35316 13x18 cm



ART. 47522 P
↓ 28 ↔ 15 cm

ART. 47022 P T
↓ 28 ↔ 15 cm

ART. 47523 R
↓ 28 ↔ 15 cm

ART. 47023 R
↓ 28 ↔ 15 cm



ART. 47524 R
↓ 21 ↔ 12 cm

ART. 47024 R T
↓ 21 ↔ 12 cm



ART. 49525 P
↓ 19 ↔ 17 cm

ART. 49025 P T
↓ 19 ↔ 17 cm

ART. 49524 R
↓ 19 ↔ 17 cm

ART. 49024 R
↓ 19 ↔ 17 cm



ART. 46523 Ø 6
↓ 23 ↔ 10 cm

ART. 46023 Ø 6 T
↓ 23 ↔ 10 cm



ART. 46524 Ø 5
↓ 19 ↔ 8 cm

ART. 46024 Ø 5 T
↓ 19 ↔ 8 cm



ART. 49202 R
↓ 12 ↔ 10 cm

ART. 49102 R T
↓ 12 ↔ 10 cm



ART. 46831
↓ 22 ↔ 17 cm



ART. 46930
↓ 18 ↔ 13 cm

ART. 46830 T
↓ 18 ↔ 13 cm



ART. 40130 7x9 cm
ART. 40131 8x10 cm
ART. 40132 9x12 cm
ART. 40133 11x15 cm
ART. 40134 13x18 cm
ART. 40135 18x24 cm



ART. 40140 7x9 cm
ART. 40141 8x10 cm
ART. 40142 9x12 cm
ART. 40143 10x15 cm
ART. 40144 11x15 cm
ART. 40145 13x18 cm
ART. 40146 18x24 cm



ART. 33010 10x5 cm
ART. 33012 12x5 cm
ART. 33015 15x6 cm
ART. 33020 20x6 cm
ART. 33025 25x8 cm
ART. 33030 30x8 cm
ART. 33040 40x10 cm
ART. 33050 50x12 cm



ART. 47003 R
↓ 50 ↔ 23 cm



ART. 47001 P
↓ 28 ↔ 16 cm
ART. 47007 R
↓ 28 ↔ 16 cm



ART. 47500 P
↓ 20 ↔ 11 cm
ART. 47506 R
↓ 20 ↔ 11 cm



ART. 47504 P
↓ 12 ↔ 8 cm
ART. 47509 R
↓ 12 ↔ 8 cm



ART. 49500 P
↓ 18 ↔ 16 cm
ART. 49501 R
↓ 18 ↔ 16 cm

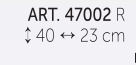

ART. 47002 R
↓ 40 ↔ 23 cm

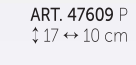

ART. 47609 P
↓ 17 ↔ 10 cm

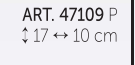

ART. 47109 P
↓ 17 ↔ 10 cm

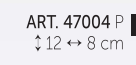

ART. 47004 P
↓ 12 ↔ 8 cm



ART. 49100 P
↓ 18 ↔ 16 cm

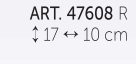

ART. 47608 R
↓ 17 ↔ 10 cm

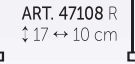

ART. 47108 R
↓ 17 ↔ 10 cm

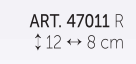

ART. 47011 R
↓ 12 ↔ 8 cm

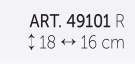

ART. 49101 R
↓ 18 ↔ 16 cm



ART. 46817 T
↓ 25 ↔ 14 cm



ART. 46913 P
↓ 20 ↔ 14 cm



ART. 46916 P
↓ 17 ↔ 12 cm



ART. 46001 T
Ø 6 ↓ 27 ↔ 15 cm



ART. 46500 P
Ø 5 ↓ 20 ↔ 9 cm



ART. 46503 P
Ø 4 ↓ 14 ↔ 6 cm

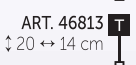

ART. 46813 T
↓ 20 ↔ 14 cm

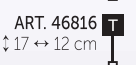

ART. 46816 T
↓ 17 ↔ 12 cm

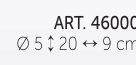

ART. 46000 T
Ø 5 ↓ 20 ↔ 9 cm



ART. 46003 T
Ø 4 ↓ 14 ↔ 6 cm



ART. 46915 P
↓ 9 ↔ 8 cm

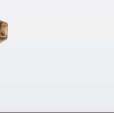

ART. 46815 T
↓ 9 ↔ 8 cm



ART. 40600 P
19 ↔ 15 cm



ART. 40301 P
Ø 5 ↓ 19 ↔ 13 cm



ART. 40102 8x10 cm
ART. 40100 9x12 cm
ART. 40101 11x15 cm
ART. 40103 13x18 cm
ART. 40104 18x24 cm



ART. 40119 8x10 cm
ART. 40120 9x12 cm
ART. 40122 10x15 cm
ART. 40121 11x15 cm
ART. 40124 13x18 cm
ART. 40123 18x24 cm



ART. 41000 15x8 cm
ART. 41001 20x11 cm
ART. 41002 25x14 cm
ART. 41003 30x14 cm



ART. 41005 15x8 cm
ART. 41006 20x11 cm
ART. 41007 25x14 cm
ART. 41008 30x14 cm



ART. 47541 R **P**
 ↓ 28 ↔ 19 cm



ART. 47131 R **T**
 ↓ 28 ↔ 19 cm

ART. 47630 R **P**
 ↓ 21 ↔ 14 cm

ART. 47130 R **T**
 ↓ 21 ↔ 14 cm



ART. 49535 R **P**
 ↓ 19 ↔ 17 cm

ART. 49035 R **T**
 ↓ 19 ↔ 17 cm



ART. 46630 Ø 5 **P**
 ↓ 19 ↔ 10 cm

ART. 46130 Ø 5 **T**
 ↓ 19 ↔ 10 cm



ART. 46831 **T**
 ↓ 22 ↔ 17 cm



ART. 46930 **P**
 ↓ 18 ↔ 13 cm

ART. 46830 **T**
 ↓ 18 ↔ 13 cm



ART. 40130 7x9 cm
 ART. 40131 8x10 cm
 ART. 40132 9x12 cm
 ART. 40133 11x15 cm
 ART. 40134 13x18 cm
 ART. 40135 18x24 cm



ART. 40140 7x9 cm
 ART. 40141 8x10 cm
 ART. 40142 9x12 cm
 ART. 40143 10x15 cm
 ART. 40144 11x15 cm
 ART. 40145 13x18 cm
 ART. 40146 18x24 cm



ART. 41248 12x5 cm
 ART. 41249 15x6 cm
 ART. 41250 20x8 cm
 ART. 41251 25x10 cm
 ART. 41252 30x13 cm
 ART. 41253 40x16 cm
 ART. 41254 50x20 cm



ART. 47667 R **P**
↓ 28 ↔ 19 cm

ART. 47167 R **T**
↓ 28 ↔ 19 cm



ART. 47666 R **P**
↓ 21 ↔ 14 cm

ART. 47166 R **T**
↓ 21 ↔ 14 cm



ART. 49683 R **P**
↓ 19 ↔ 17 cm

ART. 49183 R **T**
↓ 19 ↔ 17 cm



ART. 46666 Ø 5 **P**
↓ 19 ↔ 10 cm

ART. 46166 Ø 5 **T**
↓ 19 ↔ 10 cm



ART. 46964 **P**
↓ 18 ↔ 13 cm

ART. 46864 **T**
↓ 18 ↔ 13 cm

ART. 46872
↓ 22 ↔ 17 cm



ART. 46806 **T**
↓ 27 ↔ 15 cm



ART. 40182 9 x 12 cm
ART. 40183 11 x 15 cm
ART. 40195 13 x 18 cm

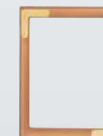

ART. 40187 9x12 cm
ART. 40188 11x15 cm
ART. 40196 13x18 cm



ART. 35303 9x12 cm
ART. 35304 11x15 cm
ART. 35317 13x18 cm



ART. 35312 9x12 cm
ART. 35313 11x15 cm
ART. 35318 13x18 cm



ART. 41120 12x5 cm
ART. 41121 15x6 cm
ART. 41122 20x8 cm
ART. 41123 25x10 cm



ART. 47117 R **T**
↓ 50 ↔ 22 cm



ART. 47116 R **T**
↓ 40 ↔ 22 cm



ART. 47612 R **P**
↓ 20 ↔ 11 cm



ART. 47624 P **P**
↓ 12 ↔ 7 cm



ART. 47186 P **T**
↓ 12 ↔ 7 cm

ART. 49531 P **P**
↓ 18 ↔ 17 cm

ART. 47112 R **T**
↓ 20 ↔ 11 cm

ART. 47623 R **P**
↓ 12 ↔ 7 cm

ART. 47185 R **P**
↓ 12 ↔ 7 cm

ART. 49131 P **T**
↓ 18 ↔ 17 cm



ART. 46925 **P**
↓ 21 ↔ 14 cm



ART. 46513 Ø 6 **P**
↓ 28 ↔ 11 cm



ART. 46612 Ø 5 **P**
↓ 20 ↔ 8 cm



ART. 46623 Ø 4 **P**
↓ 14 ↔ 8 cm

ART. 46871 **T**
↓ 21 ↔ 14 cm

ART. 46113 Ø 6 **T**
↓ 28 ↔ 11 cm

ART. 46112 Ø 5 **T**
↓ 20 ↔ 8 cm

ART. 46185 Ø 4 **T**
↓ 14 ↔ 8 cm



ART. 31633 7x9 cm
ART. 31663 8x10 cm
ART. 40106 9x12 cm
ART. 40107 11x15 cm
ART. 31664 13x18 cm



ART. 31635 7x9 cm
ART. 31636 8x10 cm
ART. 40126 9x12 cm
ART. 40127 10x15 cm
ART. 40128 11x15 cm
ART. 40139 13x18 cm



ART. 41136 ↓ 15 ↔ 6,5 cm
ART. 41137 ↓ 20 ↔ 9 cm
ART. 41138 ↓ 25 ↔ 11 cm
ART. 41139 ↓ 30 ↔ 13 cm
ART. 41140 ↓ 40 ↔ 18 cm
ART. 41141 ↓ 50 ↔ 21,5 cm



ART. 47115 R **T**
 ↓ 50 ↔ 22 cm



ART. 47114 R **T**
 ↓ 40 ↔ 22 cm



ART. 47501 P **P**
 ↓ 20 ↔ 11 cm



ART. 47622 P **P**
 ↓ 12 ↔ 7 cm



ART. 49530 P **P**
 ↓ 18 ↔ 17 cm

ART. 47610 R **T**
 ↓ 20 ↔ 11 cm

ART. 47621 R **T**
 ↓ 12 ↔ 7 cm

ART. 49130 P **T**
 ↓ 18 ↔ 17 cm

ART. 47104 P **T**
 ↓ 20 ↔ 11 cm

ART. 47184 P **T**
 ↓ 12 ↔ 7 cm

ART. 47110 R **T**
 ↓ 20 ↔ 11 cm

ART. 47175 R **T**
 ↓ 12 ↔ 7 cm



ART. 46925 **P**
 ↓ 21 ↔ 14 cm



ART. 46511 Ø 6 **P**
 ↓ 28 ↔ 11 cm



ART. 46610 Ø 5 **P**
 ↓ 20 ↔ 8 cm



ART. 46621 Ø 4 **P**
 ↓ 14 ↔ 8 cm

ART. 46871 **T**
 ↓ 21 ↔ 14 cm

ART. 46111 Ø 6 **T**
 ↓ 28 ↔ 11 cm

ART. 46110 Ø 5 **T**
 ↓ 20 ↔ 8 cm

ART. 46184 Ø 4 **T**
 ↓ 14 ↔ 8 cm



ART. 31633 7x9 cm
 ART. 31663 8x10 cm
 ART. 40106 9x12 cm
 ART. 40107 11x15 cm
 ART. 31664 13x18 cm

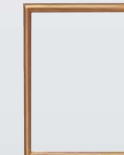

ART. 31635 7x9 cm
 ART. 31636 8x10 cm
 ART. 40126 9x12 cm
 ART. 40127 10x15 cm
 ART. 40128 11x15 cm
 ART. 40139 13x18 cm



ART. 41136 ↓ 15 ↔ 6,5 cm
 ART. 41137 ↓ 20 ↔ 9 cm
 ART. 41138 ↓ 25 ↔ 11 cm
 ART. 41139 ↓ 30 ↔ 13 cm
 ART. 41140 ↓ 40 ↔ 18 cm
 ART. 41141 ↓ 50 ↔ 21,5 cm

primaria lega patinata carrara



ART. 47610CA R **P**
↓ 20 ↔ 11 cm



ART. 47610BO R **P**
↓ 20 ↔ 11 cm

ART. 47110CA R **T**
↓ 20 ↔ 11 cm

ART. 47110BO R **T**
↓ 20 ↔ 11 cm



ART. 47622CA P **P**
ART. 47621CA R **R**
↓ 12 ↔ 7 cm

ART. 47184CA P **T**
ART. 47175CA R **R**
↓ 12 ↔ 7 cm



ART. 47622BO P **P**
ART. 47621BO R **R**
↓ 12 ↔ 7 cm

ART. 47184BO P **T**
ART. 47175BO R **R**
↓ 12 ↔ 7 cm



ART. 49530CA P **P**
↓ 18 ↔ 17 cm

ART. 49130CA P **T**
↓ 18 ↔ 17 cm



ART. 47635CA P **P**
↓ 11 ↔ 3,5 cm



ART. 47635BO P **P**
↓ 11 ↔ 3,5 cm



ART. 49530BO P **P**
↓ 18 ↔ 17 cm

ART. 49130BO P **T**
↓ 18 ↔ 17 cm



ART. 46511CA Ø 6 **P**
↓ 28 ↔ 11 cm



ART. 46610CA Ø 5 **P**
↓ 20 ↔ 8 cm



ART. 46621CA Ø 4 **P**
↓ 12 ↔ 7 cm



ART. 46925CA **P**
6GG
↓ 21 ↔ 14 cm

ART. 46871CA **T**
6GG
↓ 21 ↔ 14 cm



ART. 46925BO **P**
6GG
↓ 21 ↔ 14 cm

ART. 46871BO **T**
6GG
↓ 21 ↔ 14 cm



ART. 46621BO Ø 4 **P**
↓ 12 ↔ 7 cm



ART. 46610BO Ø 5 **P**
↓ 20 ↔ 8 cm



ART. 46511BO Ø 6 **P**
↓ 28 ↔ 11 cm

ART. 46111CA Ø 6 **T**
↓ 28 ↔ 11 cm

ART. 46110CA Ø 6 **T**
↓ 20 ↔ 8 cm

ART. 46184CA Ø 4 **T**
↓ 12 ↔ 7 cm

ART. 46184BO Ø 4 **T**
↓ 12 ↔ 7 cm

ART. 46110BO Ø 6 **T**
↓ 20 ↔ 8 cm

ART. 46111BO Ø 6 **T**
↓ 28 ↔ 11 cm

primaria lega patinata botticino





ART. 47102 P T
↓ 28 ↔ 14 cm



ART. 47600 P P ART. 47100 P T
↓ 20 ↔ 11 cm ↓ 20 ↔ 11 cm



ART. 46102 Ø 6 T
↓ 27 ↔ 13 cm



ART. 46600 Ø 5 P ART. 46100 Ø 5 T
↓ 19 ↔ 8 cm ↓ 19 ↔ 8 cm



ART. 46821 T
↓ 25 ↔ 14 cm



ART. 46922 P ART. 46822 T
↓ 20 ↔ 14 cm ↓ 20 ↔ 14 cm



ART. 46920 P ART. 46820 T
↓ 17 ↔ 11 cm ↓ 17 ↔ 11 cm



ART. 31633 7x9 cm
ART. 31663 8x10 cm
ART. 40106 9x12 cm
ART. 40107 11x15 cm
ART. 31664 13x18 cm



ART. 31635 7x9 cm
ART. 31636 8x10 cm
ART. 40126 9x12 cm
ART. 40127 10x15 cm
ART. 40128 11x15 cm
ART. 40139 13x18 cm



ART. 41136 ↓ 15 ↔ 6,5 cm
ART. 41137 ↓ 20 ↔ 9 cm
ART. 41138 ↓ 25 ↔ 11 cm
ART. 41139 ↓ 30 ↔ 13 cm
ART. 41140 ↓ 40 ↔ 18 cm
ART. 41141 ↓ 50 ↔ 21,5 cm



ART. 47663 R
↓ 20 ↔ 13 cm

ART. 47662 P
↓ 13 ↔ 8 cm

ART. 47661 R
↓ 13 ↔ 8 cm



ART. 49672 R
↓ 18 ↔ 18 cm

ART. 49172 R
↓ 18 ↔ 18 cm



Con goccia Parete
ART. 49673 R
↓ 17 ↔ 30 cm

Senza goccia
ART. 49674 R

Con goccia terreno
ART. 49173 R
↓ 17 ↔ 30 cm

Senza goccia
ART. 49174 R



ART. 46663 Ø 5
↓ 19 ↔ 9 cm

ART. 46662 Ø 4
↓ 13 ↔ 7 cm

ART. 46163 Ø 5
↓ 19 ↔ 9 cm

ART. 46162 Ø 4
↓ 13 ↔ 7 cm



ART. 47887 P
↓ 8 ↔ 17 cm

ART. 47886 R
↓ 8 ↔ 17 cm



ART. 47889 P
↓ 8 ↔ 17 cm

ART. 47888 R
↓ 8 ↔ 17 cm



ART. 46804
↓ 27 ↔ 15 cm



ART. 46914
↓ 17 ↔ 12 cm

ART. 46814
↓ 17 ↔ 12 cm

ART. 46824
↓ 25 ↔ 17 cm



ART. 41011 ↓ 15 ↔ 10 cm
ART. 41012 ↓ 20 ↔ 11 cm
ART. 33108 ↓ 30 ↔ 12 cm



ART. 40201 9x12 cm
ART. 40202 11x15 cm
ART. 40203 13x18 cm



ART. 40204 9x12 cm
ART. 40205 10x15 cm
ART. 40206 11x15 cm
ART. 40207 13x18 cm



ART. 35236 9x12 cm
ART. 35237 10x15 cm
ART. 35238 11x15 cm
ART. 35239 13x18 cm



ART. 35212 9x12 cm
ART. 35213 11x15 cm
ART. 35214 13x18 cm

fusione a terra



fusione a terra



ART. 47520 R **P**
↓ 20,5 ↔ 12 cm



ART. 47518 R **P**
↓ 20,5 ↔ 12 cm



ART. 47246 R **T**
↓ 20,5 ↔ 12 cm



ART. 47242 R **T**
↓ 20,5 ↔ 12 cm

ART. 47599 R **P**
↓ 12 ↔ 7,5 cm

ART. 47256 R **T**
↓ 12 ↔ 7,5 cm

ART. 47657 R **P**
↓ 12 ↔ 7,5 cm

ART. 47257 R **T**
↓ 12 ↔ 7,5 cm



ART. 46520 Ø 5 **P**
↓ 21 ↔ 9,5 cm

ART. 46220 Ø 5 **T**
↓ 21 ↔ 9,5 cm



ART. 49502 R **P**
↓ 18 ↔ 17,5 cm

ART. 49206 R **T**
↓ 18 ↔ 17,5 cm



ART. 49503 R **P**
↓ 18 ↔ 17,5 cm

ART. 49203 R **T**
↓ 18 ↔ 17,5 cm



ART. 46518 Ø 5 **P**
↓ 21 ↔ 9,5 cm

ART. 46218 Ø 5 **T**
↓ 21 ↔ 9,5 cm



ART. 46588 Ø 4 **P**
↓ 13 ↔ 7,5 cm

ART. 46245 Ø 4 **T**
↓ 13 ↔ 7,5 cm



ART. 31786 7x9 cm
ART. 31787 8x10 cm
ART. 31759 9x12 cm
ART. 31760 11x15 cm



ART. 31788 7x9 cm
ART. 31789 8x10 cm
ART. 31761 9x12 cm
ART. 31762 10x15 cm
ART. 31763 11x15 cm



ART. 41042 ↓ 15 cm
ART. 41043 ↓ 20 cm
ART. 41044 ↓ 25 cm
ART. 41045 ↓ 30 cm
ART. 41046 ↓ 40 cm



ART. 46589 Ø 4 **P**
↓ 13 ↔ 7,5 cm

ART. 46246 Ø 4 **T**
↓ 13 ↔ 7,5 cm



ART. 31786 7x9 cm
ART. 31787 8x10 cm
ART. 31759 9x12 cm
ART. 31760 11x15 cm



ART. 31788 7x9 cm
ART. 31789 8x10 cm
ART. 31761 9x12 cm
ART. 31762 10x15 cm
ART. 31763 11x15 cm



ART. 41042 ↓ 15 cm
ART. 41043 ↓ 20 cm
ART. 41044 ↓ 25 cm
ART. 41045 ↓ 30 cm
ART. 41046 ↓ 40 cm

fusione a terra



ART. 47519 R **P**
↓ 20,5 ↔ 12 cm



ART. 47243 R **T**
↓ 20,5 ↔ 12 cm



ART. 47521 R **P**
↓ 20,5 ↔ 12 cm

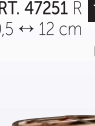

ART. 47251 R **T**
↓ 20,5 ↔ 12 cm

ART. 47658 R **P**
↓ 12 ↔ 7,5 cm

ART. 47258 R **T**
↓ 12 ↔ 7,5 cm



ART. 46519 Ø 5 **P**
↓ 21 ↔ 9,5 cm

ART. 46213 Ø 5 **T**
↓ 21 ↔ 9,5 cm



ART. 49504 R **P**
↓ 18 ↔ 17,5 cm

ART. 49204 R **T**
↓ 18 ↔ 17,5 cm



ART. 49511 R **P**
↓ 18 ↔ 17,5 cm

ART. 49205 R **T**
↓ 18 ↔ 17,5 cm



ART. 46521 Ø 5 **P**
↓ 17 ↔ 9,5 cm

ART. 46222 Ø 5 **T**
↓ 17 ↔ 9,5 cm



fusione a terra

BRONZO



ART. 46591 Ø 4 **P**
↓ 13 ↔ 7,5 cm

ART. 46251 Ø 4 **T**
↓ 13 ↔ 7,5 cm



ART. 31786 7x9 cm
ART. 31787 8x10 cm
ART. 31759 9x12 cm
ART. 31760 11x15 cm



ART. 31788 7x9 cm
ART. 31789 8x10 cm
ART. 31761 9x12 cm
ART. 31762 10x15 cm
ART. 31763 11x15 cm



ART. 41042 ↓ 15 cm
ART. 41043 ↓ 20 cm
ART. 41044 ↓ 25 cm
ART. 41045 ↓ 30 cm
ART. 41046 ↓ 40 cm



ART. 46929 **P**
↓ 18 ↔ 13 cm

ART. 46409 **T**
↓ 18 ↔ 13 cm



ART. 31790 9x12 cm
ART. 31791 11x15 cm



ART. 31792 9x12 cm
ART. 31793 10x15 cm
ART. 31794 11x15 cm



ART. 41004 ↓ 15 cm
ART. 41009 ↓ 20 cm
ART. 41010 ↓ 25 cm
ART. 41015 ↓ 30 cm
ART. 41016 ↓ 40 cm

fusione a terra

fusione a terra



ART. 47547 R P
↓ 20 ↔ 12 cm



ART. 47604 R P ART. 47224 R T
↓ 20 ↔ 12 cm ↓ 20 ↔ 12 cm

ART. 47253 R T
↓ 20 ↔ 12 cm



ART. 49624 R P ART. 49224 R T
↓ 18 ↔ 18,5 cm ↓ 18 ↔ 18,5 cm



ART. 49512 R P ART. 49207 R T ART. 46547 Ø 5 P ART. 46242 Ø 5 T
↓ 18 ↔ 18,5 cm ↓ 18 ↔ 18,5 cm ↓ 17 ↔ 9,5 cm ↓ 17 ↔ 9,5 cm



ART. 46624 Ø 5 P ART. 46224 Ø 5 T
↓ 17 ↔ 9,5 cm ↓ 17 ↔ 9,5 cm



ART. 49821
↓ 21,5 ↔ 57 cm- Interno Rame



ART. 46931 P
↓ 18 ↔ 13 cm



ART. 31795 9x12 cm
ART. 31796 11x15 cm



ART. 31797 9x12 cm
ART. 31798 10x15 cm
ART. 31799 11x15 cm



ART. 41047 ↓ 15 cm
ART. 41048 ↓ 20 cm
ART. 41049 ↓ 25 cm
ART. 41050 ↓ 30 cm
ART. 41051 ↓ 40 cm



ART. 31718 9x12 cm
ART. 31719 11x15 cm



ART. 31715 9x12 cm
ART. 31716 10x15 cm
ART. 31717 11x15 cm



ART. 41042 ↓ 15 cm
ART. 41043 ↓ 20 cm
ART. 41044 ↓ 25 cm
ART. 41045 ↓ 30 cm
ART. 41046 ↓ 40 cm



ART. 46932 P
↓ 18 ↔ 13 cm

ART. 46832 T
↓ 18 ↔ 13 cm

fusione a terra con inserto in bagno oro 24 K



ART. 47652 R P
↓ 20,5 ↔ 11 cm

ART. 47252 R T
↓ 20,5 ↔ 12 cm



ART. 47617 R P
↓ 20,5 ↔ 11 cm

ART. 47227 R T
↓ 20,5 ↔ 12 cm



ART. 49617 R P
↓ 19 ↔ 16 cm

ART. 49217 R T
↓ 19 ↔ 16 cm



ART. 46617 Ø 5 P
↓ 16,5 ↔ 9 cm

ART. 46217 Ø 5 T
↓ 16,5 ↔ 9 cm



ART. 49627 R P
↓ 19 ↔ 15 cm

ART. 49227 R T
↓ 19 ↔ 15 cm



ART. 46627 Ø 5 P
↓ 16,5 ↔ 9 cm

ART. 46227 Ø 5 T
↓ 16,5 ↔ 9 cm



ART. 46917 P
↓ 19 ↔ 12,5 cm



ART. 31767 9x12 cm
ART. 31768 11x15 cm



ART. 31769 9x12 cm
ART. 31771 10x15 cm



ART. 41042 ↓ 15 cm
ART. 41043 ↓ 20 cm
ART. 41044 ↓ 25 cm
ART. 41045 ↓ 30 cm
ART. 41046 ↓ 40 cm



ART. 46940 P
↓ 19 ↔ 12,5 cm



ART. 31740 9x12 cm
ART. 31741 11x15 cm



ART. 31742 9x12 cm
ART. 31744 10x15 cm



ART. 41042 ↓ 15 cm
ART. 41043 ↓ 20 cm
ART. 41044 ↓ 25 cm
ART. 41045 ↓ 30 cm
ART. 41046 ↓ 40 cm

fusione a terra



fusione a terra

fusione a terra



ART. 47583 R **P**
↓ 20,5 ↔ 11 cm

ART. 47255 R **T**
↓ 20,5 ↔ 12 cm



ART. 47553 R **P**
↓ 20,5 ↔ 11 cm

ART. 47254 R **T**
↓ 20,5 ↔ 12 cm



ART. 49518 R **P**
↓ 19 ↔ 15 cm

ART. 49209 R **T**
↓ 19 ↔ 15 cm



ART. 46583 Ø 5 **P**
↓ 16,5 ↔ 9 cm

ART. 46244 Ø 5 **T**
↓ 16,5 ↔ 9 cm



ART. 49513 R **P**
↓ 19 ↔ 15 cm

ART. 49208 R **T**
↓ 19 ↔ 15 cm



ART. 46522 Ø 5 **P**
↓ 16,5 ↔ 9 cm

ART. 46243 Ø 5 **T**
↓ 16,5 ↔ 9 cm



ART. 46944 **P**
↓ 19 ↔ 12,5 cm



ART. 31806 9x12 cm
ART. 31807 11x15 cm



ART. 31808 9x12 cm
ART. 31809 11x15 cm



ART. 41047 ↓ 15 cm
ART. 41048 ↓ 20 cm
ART. 41049 ↓ 25 cm
ART. 41050 ↓ 30 cm
ART. 41051 ↓ 40 cm



ART. 46942 **P**
↓ 19 ↔ 12,5 cm



ART. 31802 9x12 cm
ART. 31803 11x15 cm



ART. 31804 9x12 cm
ART. 31805 11x15 cm



ART. 41004 ↓ 15 cm
ART. 41009 ↓ 20 cm
ART. 41010 ↓ 25 cm
ART. 41015 ↓ 30 cm
ART. 41016 ↓ 40 cm

fusione a terra



ART. 47605 R **P**
↓ 20,5 ↔ 13,5 cm

ART. 47225 R **T**
↓ 20,5 ↔ 13,5 cm



ART. 47607 R **P**
↓ 20 ↔ 13,5 cm

ART. 47247 R **T**
↓ 20 ↔ 13,5 cm

ART. 47250 R
↓ 29 ↔ 15 cm

ART. 47248 R
↓ 29 ↔ 15 cm



ART. 49625 R **P**
↓ 18 ↔ 18,5 cm

ART. 49225 R **T**
↓ 18 ↔ 18,5 cm



ART. 46605 Ø 5 **P**
↓ 17 ↔ 9,5 cm

ART. 46225 Ø 5 **T**
↓ 17 ↔ 9,5 cm

ART. 46250 Ø 5
↓ 22,5 ↔ 11,5 cm



ART. 49620 R **P**
↓ 18 ↔ 18,5 cm

ART. 49020 R **T**
↓ 18 ↔ 18,5 cm



ART. 46607 Ø 5 **P**
↓ 17 ↔ 9,5 cm

ART. 46247 Ø 5 **T**
↓ 17 ↔ 9,5 cm

ART. 46248 Ø 5
↓ 22,5 ↔ 11,5 cm



ART. 46934 **P**
↓ 18 ↔ 13 cm

ART. 46834 **T**
↓ 18 ↔ 13 cm



ART. 31786 7x9 cm
ART. 31787 8x10 cm
ART. 31759 9x12 cm
ART. 31760 11x15 cm



ART. 31788 7x9 cm
ART. 31789 8x10 cm
ART. 31761 9x12 cm
ART. 31762 10x15 cm
ART. 31763 11x15 cm



ART. 41042 ↓ 15 cm
ART. 41043 ↓ 20 cm
ART. 41044 ↓ 25 cm
ART. 41045 ↓ 30 cm
ART. 41046 ↓ 40 cm



ART. 46937 **P**
↓ 18 ↔ 13 cm

ART. 46680 **T**
↓ 18 ↔ 13 cm



ART. 31786 7x9 cm
ART. 31787 8x10 cm
ART. 31759 9x12 cm
ART. 31760 11x15 cm



ART. 31788 7x9 cm
ART. 31789 8x10 cm
ART. 31761 9x12 cm
ART. 31762 10x15 cm
ART. 31763 11x15 cm



ART. 41042 ↓ 15 cm
ART. 41043 ↓ 20 cm
ART. 41044 ↓ 25 cm
ART. 41045 ↓ 30 cm
ART. 41046 ↓ 40 cm

fusione a terra



fusione a terra



ART. 47641 R **P** ART. 47241 R **T**
 ↓ 21 ↔ 13,5 cm ↓ 21 ↔ 13,5 cm



ART. 47618 R **P** ART. 47228 R **T**
 ↓ 21 ↔ 13,5 cm ↓ 21 ↔ 13,5 cm



ART. 49615 R **P** ART. 49215 R **T**
 ↓ 18 ↔ 19 cm ↓ 18 ↔ 19 cm



ART. 49631 R **P** ART. 49228 R **T**
 ↓ 18 ↔ 19 cm ↓ 18 ↔ 19 cm



ART. 46641 Ø 5 **P** ART. 46241 Ø 5 **T**
 ↓ 17 ↔ 10,5 cm ↓ 17 ↔ 10,5 cm



ART. 49824 R **P**
 ↓ 22 ↔ 56,5 cm



ART. 46608 Ø 5 **P** ART. 46228 Ø 5 **T**
 ↓ 17 ↔ 10,5 cm ↓ 17 ↔ 10,5 cm



ART. 49823 R **P**
 ↓ 22 ↔ 56,5 cm



ART. 46903 **P**
 ↓ 19 ↔ 12,5 cm



ART. 31786 7x9 cm
 ART. 31787 8x10 cm
 ART. 31759 9x12 cm
 ART. 31760 11x15 cm



ART. 31788 7x9 cm
 ART. 31789 8x10 cm
 ART. 31761 9x12 cm
 ART. 31762 10x15 cm
 ART. 31763 11x15 cm



ART. 41042 ↓ 15 cm
 ART. 41043 ↓ 20 cm
 ART. 41044 ↓ 25 cm
 ART. 41045 ↓ 30 cm
 ART. 41046 ↓ 40 cm



ART. 46945 **P**
 ↓ 19 ↔ 12,5 cm



ART. 31730 9x12 cm
 ART. 31731 11x15 cm



ART. 31732 9x12 cm
 ART. 31733 10x15 cm
 ART. 31734 11x15 cm



ART. 41042 ↓ 15 cm
 ART. 41043 ↓ 20 cm
 ART. 41044 ↓ 25 cm
 ART. 41045 ↓ 30 cm
 ART. 41046 ↓ 40 cm

fusione a terra con inserto a cera persa



fusione a terra con inserto in acciaio inox microfuso

fusione a terra con inserto in acciaio inox microfuso in bagno oro 24k



ART. 47640 R P ART. 47226 R T
 ↓ 21 ↔ 13,5 cm ↓ 21 ↔ 13,5 cm

ART. 47649 R P ART. 47249 R T
 ↓ 21 ↔ 13,5 cm ↓ 21 ↔ 13,5 cm

ART. 49630 R P ART. 49226 R T
 ↓ 18 ↔ 19 cm ↓ 18 ↔ 19 cm

ART. 49616 R P ART. 49216 R T
 ↓ 18 ↔ 19 cm ↓ 18 ↔ 19 cm

ART. 46606 Ø 5 P ART. 46226 Ø 5 T
 ↓ 17 ↔ 10,5 cm ↓ 17 ↔ 10,5 cm

ART. 49822 R P
 ↓ 22 ↔ 56,5 cm

ART. 46649 Ø 5 P ART. 46249 Ø 5 T
 ↓ 17 ↔ 10,5 cm ↓ 17 ↔ 10,5 cm

ART. 49825 R P
 ↓ 22 ↔ 56,5 cm

ART. 46933 P
 ↓ 19 ↔ 12,5 cm
 ART. 46833 T
 ↓ 19 ↔ 12,5 cm

ART. 31735 9x12 cm
 ART. 31736 11x15 cm

ART. 31737 9x12 cm
 ART. 31738 10x15 cm
 ART. 31739 11x15 cm

ART. 41042 ↓ 15 cm
 ART. 41043 ↓ 20 cm
 ART. 41044 ↓ 25 cm
 ART. 41045 ↓ 30 cm
 ART. 41046 ↓ 40 cm

ART. 46912 P
 ↓ 19 ↔ 12,5 cm
 ART. 46828 T
 ↓ 19 ↔ 12,5 cm

ART. 31747 9x12 cm
 ART. 31748 11x15 cm

ART. 31764 9x12 cm
 ART. 31765 10x15 cm
 ART. 31766 11x15 cm

ART. 41042 ↓ 15 cm
 ART. 41043 ↓ 20 cm
 ART. 41044 ↓ 25 cm
 ART. 41045 ↓ 30 cm
 ART. 41046 ↓ 40 cm

fusione a terra

fusione a cera persa



ART. 47619 R P ART. 47229 R T
 ↓ 20 ↔ 11,5 cm ↓ 20 ↔ 11,5 cm



ART. 47626 R P ART. 47126 R T
 ↓ 20 ↔ 13,5 cm ↓ 20 ↔ 13,5 cm
 ART. 47121 R T
 ↓ 28 ↔ 20 cm



ART. 49614 R P ART. 49229 R T
 ↓ 19 ↔ 16 cm ↓ 19 ↔ 16 cm



ART. 46935 P ART. 46835 T
 ↓ 19 ↔ 12,5 cm ↓ 19 ↔ 12,5 cm



ART. 49626 R P ART. 49126 R T
 ↓ 16 ↔ 17 cm ↓ 16 ↔ 17 cm



ART. 46904 P ART. 46704 T
 ↓ 18 ↔ 13 cm ↓ 18 ↔ 13 cm
 ART. 46703 T
 ↓ 21 ↔ 17 cm



ART. 46609 Ø 5 P ART. 46229 Ø 5 T
 ↓ 16,5 ↔ 9 cm ↓ 16,5 ↔ 9 cm



ART. 31745 9x12 cm



ART. 31746 9x12 cm



ART. 46626 Ø 5 P ART. 46126 Ø 5 T
 ↓ 21 ↔ 9 cm ↓ 21 ↔ 9 cm
 ART. 46121 Ø 5 T
 ↓ 27 ↔ 13 cm



ART. 31700 9x12 cm
 ART. 31701 11x15 cm



ART. 31720 9x12 cm
 ART. 31721 10x15 cm
 ART. 31722 11x15 cm



ART. 47063A P
↓ 28 ↔ 16 cm



ART. 47532A P
↓ 20 ↔ 10 cm



ART. 49552A P
↓ 18 ↔ 15 cm



ART. 46531A Ø 5
↓ 19 ↔ 8 cm

ART. 46031A Ø 5
↓ 19 ↔ 8 cm



ART. 47067 P
↓ 28 ↔ 13 cm



ART. 47065 P
↓ 28 ↔ 13 cm



ART. 47066 P
↓ 28 ↔ 13 cm



ART. 47068 P
↓ 28 ↔ 13 cm



ART. 46865
↓ 24 ↔ 13 cm



ART. 46856
↓ 27 ↔ 15 cm



ART. 46065 Ø 6
↓ 25 ↔ 12 cm



ART. 46066 Ø 6
↓ 25 ↔ 12 cm



ART. 46068 Ø 6
↓ 25 ↔ 12 cm

SERIE **HOLLY**



ART. 47606 P
↓ 17,5 ↔ 8 cm



ART. 46603 Ø 5
↓ 18,5 ↔ 6,5 cm



ART. 47603
↓ 17,5 ↔ 8 cm



ART. 37204 P
↓ 23 ↔ 10 cm



ART. 37203 P
↓ 18 ↔ 8,5 cm



ART. 37202 P
↓ 14 ↔ 6 cm



ART. 37214 P
↓ 19 ↔ 10,5 cm



ART. 37405 R
↓ 15 ↔ 9 cm
ART. 37406 R
↓ 20 ↔ 10 cm
ART. 37407 R
↓ 24 ↔ 12 cm
ART. 37408 R
↓ 30 ↔ 14 cm



ART. 37206 R
↓ 15 ↔ 9 cm
ART. 37207 R
↓ 20 ↔ 10 cm
ART. 37208 R
↓ 24 ↔ 12 cm
ART. 37209 R
↓ 30 ↔ 14 cm



FIAMMA SINISTRA
ART. 43700 P Ø 6
↓ 29 ↔ 29 cm



FIAMMA DESTRA
ART. 43702 P Ø 6
↓ 29 ↔ 29 cm



ART. 39018 P
↓ 19 ↔ 15 cm



ART. 49505 P
↓ 18 ↔ 13 cm



PORTAFIORE RAME
finitura neutra

ART. 37428
↓ 10 ↔ 5 cm
ART. 37427
↓ 13 ↔ 6 cm
ART. 37426
↓ 18 ↔ 8 cm



PORTAFIORE RAME
finitura renaissance

ART. 37422
↓ 10 ↔ 5 cm
ART. 37421
↓ 13 ↔ 6 cm
ART. 37420
↓ 18 ↔ 8 cm



PORTAFIORE RAME
finitura dorata

ART. 37425
↓ 10 ↔ 5 cm
ART. 37424
↓ 13 ↔ 6 cm
ART. 37423
↓ 18 ↔ 8 cm



ART. 37404 P
↓ 23 ↔ 10 cm



ART. 37403 P
↓ 18 ↔ 8,5 cm



ART. 37402 P
↓ 14 ↔ 6 cm



ART. 37418 P
↓ 19 ↔ 10,5 cm



ART. 37412 R
↓ 17 ↔ 11 cm



ART. 37417 P
↓ 16 ↔ 10,5 cm

ART. 37413 R
↓ 20 ↔ 11 cm



ART. 37411 R
↓ 20 ↔ 10 cm



ART. 36156 Ø 5
↓ 19 ↔ 10 cm



Ribaltina ART. 36060
↓ 17,5 ↔ 38 4,8 cm



ART. 46590 Ø 5
↓ 23 ↔ 7 cm



ART. 36153 Ø 5 P
↓ 16 ↔ 9 cm



ART. 36013 Ø 5 T
↓ 17 ↔ 9 cm



ART. 36012 Ø 4 T
↓ 13 ↔ 7 cm



ART. 36152 Ø 4 P
↓ 13 ↔ 7 cm



ART. 36353
↓ 13 ↔ 11 cm

ART. 37217 R
↓ 22 ↔ 10 cm

ART. 36020 Ø 5
↓ 22 ↔ 10 cm

ART. 36203
↓ 16 ↔ 11 cm



ART. 47315 P
↓ 13 ↔ 7 cm

ART. 46315 Ø 4 P
↓ 13,5 ↔ 7 cm

ART. 47307 P
↓ 13,5 ↔ 7 cm

ART. 46306 Ø 4 P
↓ 14 ↔ 6 cm

ART. 47307MO P
↓ 13,5 ↔ 7 cm

ART. 46306MO Ø 4 P
↓ 14 ↔ 6 cm

ART. 47546 P
↓ 12 ↔ 7 cm

ART. 46543 Ø 4 P
↓ 14 ↔ 7 cm

ART. 47503 P
↓ 12 ↔ 7 cm

ART. 46502 Ø 4 P
↓ 14 ↔ 7 cm

ART. 47503MO P
↓ 12 ↔ 7 cm

ART. 46502MO Ø 4 P
↓ 14 ↔ 7 cm

ART. 47316 R
↓ 13 ↔ 7 cm

ART. 46016 Ø 4 T
↓ 13,5 ↔ 7 cm

ART. 47267 P
↓ 13,5 ↔ 7 cm

ART. 46009 Ø 4 T
↓ 14 ↔ 6 cm

ART. 47267MO P
↓ 13,5 ↔ 7 cm

ART. 46009MO Ø 4 T
↓ 14 ↔ 6 cm

ART. 47543 R
↓ 12 ↔ 7 cm

ART. 46043 Ø 4 T
↓ 14 ↔ 7 cm

ART. 47502 R
↓ 12 ↔ 7 cm

ART. 46013 Ø 4 T
↓ 14 ↔ 7 cm

ART. 47502MO R
↓ 12 ↔ 7 cm

ART. 46013MO Ø 4 T
↓ 14 ↔ 7 cm

ART. 47275 P
↓ 13 ↔ 7 cm

ART. 47276 R
↓ 13 ↔ 7 cm

ART. 47046 P
↓ 12 ↔ 7 cm

ART. 47043 R
↓ 12 ↔ 7 cm

ART. 47013 P
↓ 12 ↔ 7 cm

ART. 47012 R
↓ 12 ↔ 7 cm

ART. 47013MO P
↓ 12 ↔ 7 cm

ART. 47012MO R
↓ 12 ↔ 7 cm



ART. 47309 P
↓ 13 ↔ 7,5 cm

ART. 46304 Ø 4 P
↓ 13 ↔ 6,5 cm

ART. 47309MO P
↓ 13 ↔ 7,5 cm

ART. 46304MO Ø 4 P
↓ 13 ↔ 6,5 cm

ART. 47309DU P
↓ 13 ↔ 7,5 cm

ART. 46304DU Ø 4 P
↓ 13 ↔ 6,5 cm

ART. 47655 P
↓ 13 ↔ 7 cm

ART. 47155 P T
↓ 13 ↔ 7 cm

ART. 46654 Ø 4 P
↓ 13 ↔ 7 cm

ART. 47655DU P
↓ 13 ↔ 7 cm

ART. 47155DU P T
↓ 13 ↔ 7 cm

ART. 46654DU Ø 4 P
↓ 13 ↔ 7 cm

ART. 47010 P
↓ 13 ↔ 7,5 cm

ART. 46004 Ø 4 T
↓ 13 ↔ 6,5 cm

ART. 47010MO P
↓ 13 ↔ 7,5 cm

ART. 46004MO Ø 4 T
↓ 13 ↔ 6,5 cm

ART. 47010DU P
↓ 13 ↔ 7,5 cm

ART. 46004DU Ø 4 T
↓ 13 ↔ 6,5 cm

ART. 47654 R
↓ 13 ↔ 7 cm

ART. 47154 R
↓ 13 ↔ 7 cm

ART. 46154 Ø 4 T
↓ 13 ↔ 7 cm

ART. 47654DU R
↓ 13 ↔ 7 cm

ART. 47154DU R
↓ 13 ↔ 7 cm

ART. 46154DU Ø 4 T
↓ 13 ↔ 7 cm



ART. 47678 P
↓ 12 ↔ 7 cm

ART. 47178 P T
↓ 12 ↔ 7 cm

ART. 46678 Ø 4 P
↓ 13 ↔ 7 cm

ART. 47676 P
↓ 12 ↔ 7 cm

ART. 47176 P T
↓ 12 ↔ 7 cm

ART. 46676 Ø 4 P
↓ 13 ↔ 7 cm

ART. 47662 P
↓ 13 ↔ 8 cm

ART. 47162 P T
↓ 13 ↔ 8 cm

ART. 46662 Ø 4 P
↓ 13 ↔ 7 cm

ART. 47561 P
↓ 13 ↔ 7 cm

ART. 47157 P T
↓ 13 ↔ 7 cm

ART. 46557 Ø 4 P
↓ 13 ↔ 7 cm

ART. 47689 R
↓ 12 ↔ 7 cm

ART. 47189 R
↓ 12 ↔ 7 cm

ART. 46178 Ø 4 T
↓ 13 ↔ 7 cm

ART. 47677 R
↓ 12 ↔ 7 cm

ART. 47177 R
↓ 12 ↔ 7 cm

ART. 46176 Ø 4 T
↓ 13 ↔ 7 cm

ART. 47661 R
↓ 13 ↔ 8 cm

ART. 47161 R
↓ 13 ↔ 8 cm

ART. 46162 Ø 4 T
↓ 13 ↔ 7 cm

ART. 47563 R
↓ 13 ↔ 7 cm

ART. 47156 R
↓ 13 ↔ 7 cm

ART. 46156 Ø 4 T
↓ 13 ↔ 7 cm



ART. 47508 P
↓ 13 ↔ 6 cm



ART. 47008 P T
↓ 13 ↔ 6 cm

ART. 46508 Ø 4
↓ 13 ↔ 6 cm



ART. 47504 P
↓ 12 ↔ 8 cm

ART. 47004 P T
↓ 13 ↔ 7 cm



ART. 46503 Ø 4
↓ 14 ↔ 6 cm



ART. 47599 R P
↓ 12 ↔ 7,5 cm



ART. 46588 Ø 4
↓ 13 ↔ 7,5 cm



Finitura Folk
ART. 47657 R P
↓ 12 ↔ 7,5 cm



ART. 46589 Ø 4
↓ 13 ↔ 7,5 cm



Finitura Blues
ART. 47658 R P
↓ 12 ↔ 7,5 cm



ART. 46591 Ø 4
↓ 13 ↔ 7,5 cm

ART. 47507 R
↓ 13 ↔ 6 cm

ART. 47009 R
↓ 13 ↔ 6 cm

ART. 46008 Ø 4
↓ 13 ↔ 6 cm

ART. 47509 R
↓ 12 ↔ 8 cm

ART. 47011 R
↓ 12 ↔ 8 cm

ART. 46003 Ø 4
↓ 14 ↔ 6 cm

ART. 47256 R T
↓ 12 ↔ 7,5 cm

ART. 46245 Ø 4
↓ 13 ↔ 7,5 cm

ART. 47257 R T
↓ 12 ↔ 7,5 cm

ART. 46246 Ø 4
↓ 13 ↔ 7,5 cm

ART. 47258 R T
↓ 12 ↔ 7,5 cm

ART. 46251 Ø 4
↓ 13 ↔ 7,5 cm



ART. 47624 P
↓ 12 ↔ 7 cm

ART. 47186 P T
↓ 12 ↔ 7 cm

ART. 46623 Ø 4
↓ 14 ↔ 8 cm

ART. 47622 P
↓ 12 ↔ 7 cm

ART. 47184 P T
↓ 12 ↔ 7 cm

ART. 46621 Ø 4
↓ 14 ↔ 8 cm



ART. 47611 P
cm ↓ 11 ↔ 5 cm



ART. 46611 P
Ø 4 cm
↓ 10,5 ↔ 5 cm



ART. 47540 P
↓ 12 ↔ 5 cm



ART. 46540 Ø 4
↓ 12 ↔ 5 cm

ART. 47623 R
↓ 12 ↔ 7 cm

ART. 47185 R
↓ 12 ↔ 7 cm

ART. 46185 Ø 4
↓ 14 ↔ 8 cm

ART. 47621 R
↓ 12 ↔ 7 cm

ART. 47175 R
↓ 12 ↔ 7 cm

ART. 46184 Ø 4
↓ 14 ↔ 8 cm

ART. 47040 P T
↓ 13 ↔ 7 cm

ART. 46040 Ø 4
↓ 13 ↔ 5 cm



ART. 47331 P
↓ 13 ↔ 7 cm

ART. 47259 P T
↓ 13,5 ↔ 7,5 cm

ART. 46331 Ø 4
↓ 13,5 ↔ 7,5 cm

ART. 47331DU P
↓ 13 ↔ 7 cm

ART. 47259DU P T
↓ 13,5 ↔ 7,5 cm

ART. 46331DU Ø 4
↓ 13,5 ↔ 7,5 cm



ART. 47505 R P
↓ 15,5 ↔ 4,5 cm



ART. 47300 P
↓ 12,5 ↔ 6 cm



ART. 47635 P
↓ 11 ↔ 3,5 cm



con biadesivo
ART. 47637 P
↓ 12 ↔ 5 cm

ART. 47332 R
↓ 13 ↔ 7 cm

ART. 47260 R
↓ 13 ↔ 7,5 cm

ART. 46259 Ø 4
↓ 13,5 ↔ 7,5 cm

ART. 47332DU R
↓ 13 ↔ 7 cm

ART. 47260DU R
↓ 13 ↔ 7,5 cm

ART. 46259DU Ø 4
↓ 13,5 ↔ 7,5 cm

ART. 47005 R T
↓ 15,5 ↔ 4,5 cm



ART. 47331BI P
↓ 13 ↔ 7 cm

ART. 47332BI R
↓ 13 ↔ 7 cm

ART. 47259BI P
↓ 13,5 ↔ 7,5 cm

ART. 47260BI R
↓ 13 ↔ 7,5 cm



ART. 46331BI Ø 4 P
↓ 13,5 ↔ 7,5 cm

ART. 46259BI Ø 4 T
↓ 13,5 ↔ 7,5 cm



ART. 47331CA P
↓ 13 ↔ 7 cm

ART. 47332CA R
↓ 13 ↔ 7 cm



ART. 47259CA P
↓ 13,5 ↔ 7,5 cm

ART. 47260CA R
↓ 13 ↔ 7,5 cm



ART. 46331CA Ø 4 P
↓ 13,5 ↔ 7,5 cm

ART. 46259CA Ø 4 T
↓ 13,5 ↔ 7,5 cm



ART. 47655CA P
↓ 13 ↔ 7 cm

ART. 47654CA R
↓ 13 ↔ 7 cm

ART. 47155CA P
↓ 13 ↔ 7 cm

ART. 47154CA R
↓ 13 ↔ 7 cm



ART. 46654CA P
Ø 4 ↓ 13 ↔ 7 cm

ART. 46154CA T
Ø 4 ↓ 13 ↔ 7 cm



ART. 47655BO P
↓ 13 ↔ 7 cm

ART. 47654BO R
↓ 13 ↔ 7 cm

ART. 47155BO P
↓ 13 ↔ 7 cm

ART. 47154BO R
↓ 13 ↔ 7 cm



ART. 46654BO P
Ø 4 ↓ 13 ↔ 7 cm

ART. 46154BO T
Ø 4 ↓ 13 ↔ 7 cm



ART. 47331BO P
↓ 13 ↔ 7 cm

ART. 47332BO R
↓ 13 ↔ 7 cm

ART. 47259BO Ø 4 T
↓ 13,5 ↔ 7,5 cm

ART. 47260BO R
↓ 13 ↔ 7,5 cm

ART. 46331BO Ø 4 P
↓ 13,5 ↔ 7,5 cm

ART. 46259BO Ø 4 T
↓ 13,5 ↔ 7,5 cm



ART. 47678CA P
13x7 cm



ART. 46678CA P
Ø cm 4 - 12x7 cm



ART. 47504CA P
12x8 cm



ART. 46503CA P
Ø cm 4 - 14x6 cm



ART. 47309BI P
↓ 13 ↔ 7,5 cm

ART. 47010BI P
↓ 13 ↔ 7,5 cm



ART. 46304BI Ø 4 P
↓ 13 ↔ 6,5 cm

ART. 46004BI Ø 4 T
↓ 13 ↔ 6,5 cm



ART. 47309BO P
↓ 13 ↔ 7,5 cm

ART. 47010BO P
↓ 13 ↔ 7,5 cm



ART. 46304BO Ø 4 P
↓ 13 ↔ 6,5 cm

ART. 46004BO Ø 4 T
↓ 13 ↔ 6,5 cm



ART. 47309CA P
↓ 13 ↔ 7,5 cm

ART. 47010CA P
↓ 13 ↔ 7,5 cm



ART. 46304CA Ø 4 P
↓ 13 ↔ 6,5 cm

ART. 46004CA Ø 4 T
↓ 13 ↔ 6,5 cm



ART. 47622CA P
↓ 12 ↔ 7 cm

ART. 47621CA R
↓ 12 ↔ 7 cm



ART. 47184CA P
↓ 12 ↔ 7 cm

ART. 47175CA R
↓ 12 ↔ 7 cm

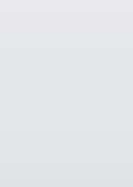

ART. 46621CA Ø 4 P
↓ 12 ↔ 7 cm

ART. 46184CA Ø 4 T
↓ 12 ↔ 7 cm



ART. 47622BO P
↓ 12 ↔ 7 cm

ART. 47184BO P
↓ 12 ↔ 7 cm



ART. 46621BO Ø 4 P
↓ 12 ↔ 7 cm

ART. 46184BO Ø 4 T
↓ 12 ↔ 7 cm



ART. 47300BI P
↓ 12,5 ↔ 6 cm



ART. 47300BO P
↓ 12,5 ↔ 6 cm



ART. 47300CA P
↓ 12,5 ↔ 6 cm



ART. 47635CA P
↓ 11 ↔ 3,5 cm



ART. 47635BO P
↓ 11 ↔ 3,5 cm

Finitura lucida e finitura opaca



NOVITÀ



ART. 47659 P
 ↓ 14 ↔ 7,5 cm



ART. 47659 P
 ↓ 13 ↔ 5,5 cm



ART. 47659BO P
 ↓ 13 ↔ 5,5 cm



ART. 47659CA P
 ↓ 13 ↔ 5,5 cm



ART. 47659MO P
 ↓ 13 ↔ 5,5 cm



ART. 47659DU P
 ↓ 13 ↔ 5,5 cm

| | | | | | | | | |
|-------------------------------|--------------------------------|-----------------------------|-------------------------------|-------------------------------|---------------------------------|-------------------------------|---------------------------------|-------------------------------|
| | | | | | | | | |
| VEL VERDE LUCIDO | BIL BIANCO LUCIDO | BLL BLU LUCIDO | VIL VIOLA LUCIDO | ROL ROSSO LUCIDO | TOL TORTORA LUCIDO | BEL BEIGE LUCIDO | AZL AZZURRO LUCIDO | STL SATÈN LUCIDO |
| | | | | | | | | |
| VEO VERDE OPACO | BIO BIANCO OPACO | BLO BLU OPACO | VIO VIOLA OPACO | ROO ROSSO OPACO | TOO TORTORA OPACO | BEO BEIGE OPACO | AZO AZZURRO OPACO | STO SATÈN OPACO |

Per ordinazioni aggiungere al codice articolo la sigla corrispondente alla colorazione scelta.
 To place orders add to the article code the letter corresponding the selected colouring.



Finitura lucida e finitura opaca



ART. 47653 P
↓ 14 ↔ 7,5 cm



ART. 47653 P
↓ 14 ↔ 7,5 cm



ART. 47653BO P
↓ 14 ↔ 7,5 cm



ART. 47653CA P
↓ 14 ↔ 7,5 cm



ART. 47653MO P
↓ 14 ↔ 7,5 cm



ART. 47653DU P
↓ 14 ↔ 7,5 cm



A tutta la serie **UNITED** e **UNITED RIFLESSI** possono essere abbinati e forniti a parte gli accessori:
73709- interno
90457- lumino a pile Ø 3 ↓ 10

Per ordinazioni aggiungere al codice articolo la sigla corrispondente alla colorazione scelta.
To place orders add to the article code the letter corresponding the selected colouring.

Pannello solare regolabile con accumulatore



ART. 36090
↓ 12 ↔ 11 cm



ART. 46875
↓ 27 ↔ 15 cm



ART. 46876
↓ 27 ↔ 15 cm



ART. 46877
↓ 24 ↔ 13 cm



ART. 47453 P
↓ 6 ↔ 16 cm



ART. 47452 P
↓ 3 ↔ 16 cm



ART. 47476 R
Ø 15 cm

ART. 47459 R
↓ 6 ↔ 16 cm

ART. 47458 R
↓ 3 ↔ 16 cm

LAMPADE A CERO 4 CRISTALLI



ART. 46860
↓ 26 ↔ 14 cm



ART. 46859
↓ 22 ↔ 14 cm



ART. 46851
↓ 22 ↔ 14 cm



ART. 46852
↓ 26 ↔ 14 cm



ART. 46870 Ø 6
↓ 20 ↔ 10 cm



ART. 46868 Ø 5
↓ 17 ↔ 10 cm



ART. 46869 Ø 6
↓ 16 ↔ 10 cm



ART. 46867 Ø 5
↓ 15 ↔ 10 cm



ART. 46758 Ø 6
↓ 15,5 ↔ 16 cm



ART. 46711
↓ 7 ↔ 16 cm



ART. 46710
↓ 2 ↔ 12 cm



ART. 36310 P
↓ 7 ↔ 15,5 cm



ART. 47874 P
↓ 4 ↔ 15,5 cm



ART. 46749 Ø 6
↓ 16 ↔ 9 cm



ART. 46748 Ø 5
↓ 13,5 ↔ 9 cm



ART. 47469 P
↓ 8 ↔ 17 cm



ART. 46895
Ø 5 ↓ 16 ↔ 9 cm

ART. 47875 R
↓ 4 ↔ 15,5 cm

ART. 47468 R
↓ 8 ↔ 17 cm



ART. 47892 R
↓ 5 Ø 19 cm



ART. 47474 P
↓ 3 ↔ 16 cm



ART. 47890 R
↓ 3 Ø 13,5 cm



ART. 36303
↓ 12 ↔ 18,5 cm



ART. 37303 P
↓ 10 ↔ 18 cm



ART. 37304 P
↓ 1,5 ↔ 17,5 cm

ART. 47893 P
↓ 5 Ø 19 cm

ART. 47475 R
↓ 3 ↔ 16 cm

ART. 47895 P
↓ 3 Ø 13,5 cm



ART. 46893
Ø 6 ↓ 3 cm Ø 13,5 cm



ART. 46892
Ø 5 ↓ 2 cm Ø 9 cm



ART. 47887 P
↓ 8 ↔ 17 cm



ART. 47889 P
↓ 8 ↔ 17 cm



ART. 36300 P
↓ 12 ↔ 18,5 cm



ART. 37300 P
↓ 10 ↔ 18 cm



ART. 37301 P
↓ 1,5 ↔ 17,5 cm

ART. 47886 R
↓ 8 ↔ 17 cm

ART. 47888 R
↓ 8 ↔ 17 cm

FIORIERE



ART. 47870 P
↓ 4,5 ↔ 15 cm



ART. 47872 P
↓ 9,5 ↔ 19,5 cm



ART. 46718 Ø 5
↓ 4 ↔ 9 cm

PLAFONIERA PARETE



ART. 46735
↓ 10,5 ↔ 19,5 cm



ART. 46720
↓ 9,5 ↔ 19,5 cm

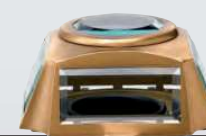

ART. 46721
↓ 10,5 ↔ 19,5 cm



ART. 40785 R
↓ 12,5 ↔ 24 cm



ART. 40788 R
↓ 12,5 ↔ 24 cm

ART. 47871 R
↓ 4,5 ↔ 15 cm

ART. 47873 R
↓ 9,5 ↔ 19,5 cm

ART. 46719 Ø 6
↓ 4 ↔ 9 cm

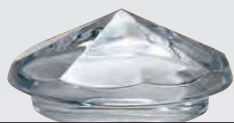

ART. 83851

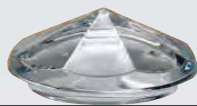

ART. 83849

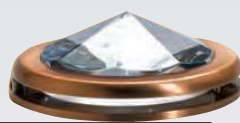

ART. 46768
Ø 12 cm

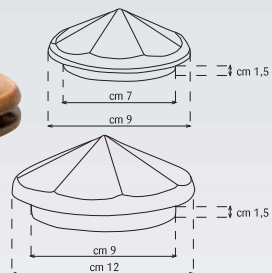

INCASSO



ART. 46717
Ø 12 cm



ART. 46713
Ø 12 cm



ART. 46710
Ø 12 cm



ART. 46732
Ø 12 cm



ART. 46733
Ø 12 cm



ART. 36035
Ø 12 cm



ART. 36033
Ø 12 cm

PORTINA



ART. 85047

FIAMMA PER PORTINA



ART. 46947
Ø 12 cm



ART. 36024
a soffitto
Ø 12 cm



FIAMMA BLU
ART. 46769B
h. 9 cm - Ø 12 cm



FIAMMA AMBRA
ART. 46769A
h. 9 cm - Ø 12 cm



FIAMMA ROSA
ART. 46769R
h. 9 cm - Ø 12 cm



FIAMMA VERDE ACQUA
ART. 46769V
h. 9 cm - Ø 12 cm



ART. 46769
h. 9 cm - Ø 12 cm



ART. 36025
Ø 9 cm



ART. 36026
Ø 9 cm



ART. 36034
Ø 9 cm



ART. 36027
Ø 9 cm



ART. 36028
Ø 9 cm



ART. 36029
Ø 9 cm



ART. 36030
Ø 9 cm



ART. 36036
Ø 9 cm



ART. 36023
a soffitto
Ø 9 cm



ART. 36031
Ø 5,5 cm

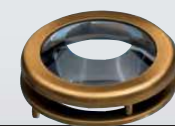

ART. 46796
Ø 5,5 cm
Compreso interno
ART. 73709



ART. 36032
Ø 5,5 cm



ART. 36037
Ø 5,5 cm



ART. 36022
a soffitto
Ø 5,5 cm



ART. 46717CA
Ø 12 cm



ART. 46733CA
Ø 12 cm



ART. 46675CA
Ø 12 cm



ART. 46732CA
Ø 12 cm



ART. 46717BO
Ø 12 cm



ART. 46733BO
Ø 12 cm



ART. 46675BO
Ø 12 cm



ART. 46732BO
Ø 12 cm



ART. 46713CA
Ø 12 cm



ART. 46710CA
Ø 12 cm



ART. 46947CA
Ø 12 cm



ART. 36025CA
Ø 9 cm



ART. 46713BO
Ø 12 cm



ART. 46710BO
Ø 12 cm



ART. 46947BO
Ø 12 cm



ART. 36025BO
Ø 9 cm



ART. 36034CA
Ø 9 cm



ART. 36027CA
Ø 9 cm



ART. 36026CA
Ø 9 cm



ART. 36029CA
Ø 9 cm



ART. 36034BO
Ø 9 cm



ART. 36027BO
Ø 9 cm



ART. 36026BO
Ø 9 cm



ART. 36029BO
Ø 9 cm



ART. 36036CA
Ø 9 cm



ART. 36032CA
Ø 5,5 cm



ART. 36031CA
Ø 5,5 cm



ART. 36037CA
Ø 5,5 cm



ART. 46796CA
Ø 5,5 cm
Compreso interno
ART. 73709



ART. 36036BO
Ø 9 cm



ART. 36032BO
Ø 5,5 cm



ART. 36031BO
Ø 5,5 cm

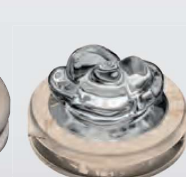

ART. 36037BO
Ø 5,5 cm



ART. 46796BO
Ø 5,5 cm
Compreso interno
ART. 73709

GHIERA DORATA



ART. 36083 Ø 5
↓ 12 ↔ 7 cm



ART. 36086 Ø 5
↓ 2 ↔ 9 cm



ART. 16074
fiamma Ø 5
↓ 12 ↔ 8,5 cm

INOX



ART. 16076
fiamma Ø 5
↓ 12 ↔ 7 cm

INOX



ART. 16077
fiamma Ø 4
↓ 8,5 ↔ 6 cm

ART. 16077SF
solo ghiera Ø 5
↓ 12 ↔ 7 cm

ART. 16077SF
solo ghiera Ø 4
↓ 8,5 ↔ 6 cm

P.L.P. BRONZO



ART. 36087 Ø 5
↓ 12 ↔ 7 cm



ART. 36089 Ø 4
↓ 9 ↔ 6 cm

OTIPRINT



CARRARA
ART. 36081CA Ø 5
↓ 12 ↔ 7 cm



BIANCO
ART. 36081BI Ø 5
↓ 12 ↔ 7 cm



BOTTICINO
ART. 36081BO Ø 5
↓ 12 ↔ 7 cm



ART. 36081
Ø 5
↓ 12 ↔ 7 cm

ART. 36081SF
↓ 12 ↔ 7 cm
solo ghiera Ø 5



ART. 36080 Ø 4
↓ 8,5 ↔ 6 cm

ART. 36080SF
↓ 8,5 ↔ 6 cm
solo ghiera Ø 4



ART. 36082 Ø 4
↓ 9,5 ↔ 3,5 cm

ART. 36088 Ø 5
↓ 13 ↔ 6,5 cm
con attacco Ø 4



CARRARA
ART. 36080CA Ø 4
↓ 8,5 ↔ 6 cm



BIANCO
ART. 36080BI Ø 4
↓ 8,5 ↔ 6 cm



BOTTICINO
ART. 36080BO Ø 4
↓ 8,5 ↔ 6 cm



fiamma cristallo
ART. 85028 Ø 5
↓ 12 cm



fiamma cristallo
ART. 85027 Ø 5
↓ 12 cm



fiamma cristallo
ART. 85026 Ø 5
↓ 12 cm



fiamma cristallo
ART. 85061 Ø 5



fiamma cristallo
ART. 85071 Ø 5
ART. 85067 Ø 4



fiamma cristallo
ART. 85052 Ø 5
ART. 85037 Ø 4



fiamma cristallo
ART. 85079 Ø 5



fiamma venezia (vetro)
ART. 85054 Ø 4
ART. 85055 Ø 5
ART. 85076 Ø 6



fiamma cristallo
ART. 85087 Ø 5



fiamma cristallo
ART. 85077 Ø 5
ART. 85036 Ø 4



fiamma roma (vetro)
ART. 85049 Ø 5
ART. 85034 Ø 4



ART. 36410 Ø 8
↓ 95 ↔ 63 cm



ART. 43523
↓ 88 ↔ 38 cm
fiamma Ø 6



ART. 43524
↓ 88 ↔ 38 cm
fiamma Ø 8



ART. 43527
↓ 94 ↔ 25 cm
fiamma Ø 6



ART. 43531
↓ 98 ↔ 27 cm
fiamma Ø 8



ART. 43520 Ø 8
↓ 125 ↔ 33 cm



ART. 36400 Ø 8
↓ 85 ↔ 40 cm



ART. 43529
↓ 92 ↔ 25 cm
per fiamma Ø 6



ART. 43528
↓ 94 ↔ 27 cm
fiamma Ø 6



ART. 43526
↓ 88 ↔ 38 cm
fiamma Ø 6



ART. 43525
↓ 88 ↔ 38 cm
fiamma Ø 6



ART. 31634 6x8 cm
 ART. 31633 7x9 cm
 ART. 31663 8x10 cm
 ART. 40106 9x12 cm
 ART. 40107 11x15 cm
 ART. 31664 13x18 cm



ART. 31635 7x9 cm
 ART. 31636 8x10 cm
 ART. 40126 9x12 cm
 ART. 40127 10x15 cm
 ART. 40128 11x15 cm
 ART. 40139 13x18 cm



ART. 31634SH 6x8 cm
 ART. 31633SH 7x9 cm
 ART. 31663SH 8x10 cm
 ART. 40106SH 9x12 cm
 ART. 40107SH 11x15 cm
 ART. 31664SH 13x18 cm



ART. 31635SH 7x9 cm
 ART. 31636SH 8x10 cm
 ART. 40126SH 9x12 cm
 ART. 40127SH 10x15 cm
 ART. 40128SH 11x15 cm
 ART. 40139SH 13x18 cm



ART. 40152 7x9 cm
 ART. 40153 8x10 cm
 ART. 40154 9x12 cm
 ART. 40155 11x15 cm



ART. 40156 9x12 cm
 ART. 40170 10x15 cm
 ART. 40171 11x15 cm



ART. 40102 8x10 cm
 ART. 40100 9x12 cm
 ART. 40101 11x15 cm
 ART. 40103 13x18 cm
 ART. 40104 18x24 cm



ART. 40119 8x10 cm
 ART. 40120 9x12 cm
 ART. 40121 11x15 cm
 ART. 40122 10x15 cm
 ART. 40124 13x18 cm
 ART. 40123 18x24 cm

OTIPRINT



CARRARA
 ART. 31633CA 7x9 cm
 ART. 31663CA 8x10 cm
 ART. 40106CA 9x12 cm
 ART. 40107CA 11x15 cm
 ART. 31664CA 13x18 cm



CARRARA
 ART. 31635CA 7x9 cm
 ART. 31636CA 8x10 cm
 ART. 40126CA 9x12 cm
 ART. 40127CA 10x15 cm
 ART. 40128CA 11x15 cm
 ART. 40139CA 13x18 cm



BOTTICINO
 ART. 31633BO 7x9 cm
 ART. 31663BO 8x10 cm
 ART. 40106BO 9x12 cm
 ART. 40107BO 11x15 cm
 ART. 31664BO 13x18 cm



BOTTICINO
 ART. 31635BO 7x9 cm
 ART. 31636BO 8x10 cm
 ART. 40126BO 9x12 cm
 ART. 40127BO 10x15 cm
 ART. 40128BO 11x15 cm
 ART. 40139BO 13x18 cm

CON INSERTO TITANIO



ART. 40201 9x12 cm
 ART. 40202 11x15 cm
 ART. 40203 13x18 cm



ART. 40204 9x12 cm
 ART. 40205 10x15 cm
 ART. 40206 11x15 cm
 ART. 40207 13x18 cm

CON INSERTO BAGNO ORO 24 K



ART. 40182 9x12 cm
 ART. 40183 11x15 cm
 ART. 40195 13x18 cm
 ART. 40168 18x24 cm



ART. 40187 9x12 cm
 ART. 40188 11x15 cm
 ART. 40196 13x18 cm
 ART. 40169 18x24 cm



BIANCO
 ART. 31633BI 7x9 cm
 ART. 31663BI 8x10 cm
 ART. 40106BI 9x12 cm
 ART. 40107BI 11x15 cm
 ART. 31664BI 13x18 cm



BIANCO
 ART. 31635BI 7x9 cm
 ART. 31636BI 8x10 cm
 ART. 40126BI 9x12 cm
 ART. 40127BI 10x15 cm
 ART. 40128BI 11x15 cm
 ART. 40139BI 13x18 cm



ART. 40160 9x12 cm
 ART. 40161 11x15 cm
 ART. 40162 13x18 cm



ART. 40165 9x12 cm
 ART. 40166 11x15 cm
 ART. 40167 13x18 cm



Inclinazione a richiesta su tutti i tipi cornici



Inclinazione a richiesta su tutti i tipi cornici



ART. 40108 9x12 cm
ART. 40109 11x15 cm
ART. 40110 13x18 cm



ART. 40111 9x12 cm
ART. 40112 11x15 cm
ART. 40113 13x18 cm



ART. 40114 9x12 cm
ART. 40115 11x15 cm
ART. 40116 13x18 cm



ROSA
ART. 38606 7x4 cm



ROSA
ART. 38607 7x4 cm



ART. 31630 8x10 cm
ART. 31631 9x12 cm
ART. 31632 11x15 cm



ART. 31630SH 8x10 cm
ART. 31631SH 9x12 cm
ART. 31632SH 11x15 cm



ART. 31621 7x9 cm
ART. 31622 8x10 cm
ART. 31623 9x12 cm
ART. 31624 11x15 cm
ART. 31625 13x18 cm
ART. 31626 18x24 cm



ART. 31674 6x8 cm
ART. 40130 7x9 cm
ART. 31675 7x10 cm
ART. 40131 8x10 cm



ART. 40140 7x9 cm
ART. 40141 8x10 cm
ART. 40142 9x12 cm
ART. 40143 10x15 cm



ART. 31659
Ø 10 cm



ART. 40148 9x12 cm
ART. 40149 11x15 cm



ART. 40150 9x12 cm
ART. 40151 11x15 cm

Inclinazione a richiesta su tutti i tipi cornici



ART. 31640 8x10 cm
ART. 31641 9x12 cm
ART. 31642 11x15 cm



ART. 31650 9x12 cm
ART. 31651 11x15 cm
ART. 31652 13x18 cm

CORNICI CON COPERCHIO



ART. 31696 6x8 cm
ART. 31775 7x9 cm
ART. 31776 8x0 cm
ART. 31777 9x2 cm

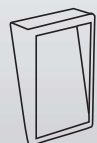

Inclinazione a richiesta su tutti i tipi cornici

CON INSERTO BAGNO ORO 24 K

CON INSERTO TITANIO



ART. 35235 9x12 cm
ART. 35245 10x15 cm
ART. 35255 11x15 cm
ART. 35247 13x18 cm



ART. 35275 9x12 cm
ART. 35215 11x15 cm
ART. 35248 13x18 cm



ART. 35312 9x12 cm
ART. 35313 11x15 cm
ART. 35318 13x18 cm



ART. 35303 9x12 cm
ART. 35304 11x15 cm
ART. 35317 13x18 cm



ART. 35236 9x12 cm
ART. 35237 10x15 cm
ART. 35238 11x15 cm
ART. 35239 13x18 cm



ART. 35212 9x12 cm
ART. 35213 11x15 cm
ART. 35214 13x18 cm



ART. 35296 9x12 cm
ART. 35138 10x15 cm
ART. 35297 11x15 cm
ART. 35316 13x18 cm



NOVITÀ

ART. 35256 9x12 cm
ART. 35257 10x15 cm
ART. 35258 11x15 cm
ART. 35259 13x18 cm



NOVITÀ

ART. 35307 9x12 cm
ART. 35308 11x15 cm
ART. 35309 13x18 cm



ART. 35320 9x12 cm
ART. 35321 10x15 cm
ART. 35322 13x18 cm



ART. 35300 9x12 cm
ART. 35301 11x15 cm
ART. 35302 13x18 cm

*Cornice a titolo d'esempio.
Non inclusa nel prezzo.*



ART. 35136 9x12 cm
ART. 35137 11x15 cm



ART. 35231 9x12 cm
ART. 35241 10x15 cm
ART. 35251 11x15 cm



ART. 35201 9x12 cm
ART. 35211 11x15 cm
ART. 35220 13x18 cm
ART. 35270 18x24 cm



ART. 35293 9x12 cm
ART. 35294 11x15 cm
ART. 35295 13x18 cm



ART. 35290 9x12 cm
ART. 35139 10x15 cm
ART. 35291 11x15 cm
ART. 35292 13x18 cm



ART. 35130
per cornice 17x13,5 cm



ART. 35133
per cornice 18x14,5 cm



ART. 35285 9x12 cm
ART. 35287 10x15 cm
ART. 35286 11x15 cm



ART. 35280 9x12 cm
ART. 35281 11x15 cm

Il prezzo di listino è comprensivo della base con incisione
dei nome, cognome e data.

ART. 35131
per cornice 22x17,5 cm

ART. 35134
per cornice 22x18 cm

ART. 35135
per cornice 26,5x21 cm



ART. 35230 9x12 cm
ART. 35240 10x15 cm
ART. 35250 11x18 cm



ART. 35200 9x12 cm
ART. 35210 11x15 cm



ART. 38415
applicazione cornice inclinata

Applicazione adottata
per inclinare qualsiasi tipo
di cornice ovale e rettangolare.



MEZZOTONDO
ART. 33106 P
↓ 30 ↔ 13 cm
ART. 33111
↓ 40 ↔ 17 cm
ART. 33116
↓ 50 ↔ 22 cm

MEZZOTONDO
ART. 41011 P
↓ 15 ↔ 10 cm
ART. 41012
↓ 20 ↔ 11 cm
ART. 33108
↓ 30 ↔ 13 cm
ART. 33113
↓ 40 ↔ 17 cm
ART. 33118
↓ 50 ↔ 22 cm

MEZZOTONDO
ART. 33107 P
↓ 30 ↔ 13 cm
ART. 33112
↓ 40 ↔ 17 cm
ART. 33117
↓ 50 ↔ 22 cm

MEZZOTONDO
ART. 33109 P
↓ 30 ↔ 13 cm
ART. 33114
↓ 40 ↔ 17 cm
ART. 33119
↓ 50 ↔ 22 cm



ART. 41271 P
↓ 47 ↔ 23 cm

ART. 41270 P
↓ 39 ↔ 21 cm

ART. 41269 P
↓ 30 ↔ 16,5 cm

ART. 41268 P
↓ 20 ↔ 10,5 cm

ART. 41267 P
↓ 10 ↔ 5,5 cm



ART. 41277 P
↓ 80 ↔ 32 cm

ART. 41278 T
↓ 82 ↔ 32 cm



ART. 41275 P
↓ 78 ↔ 36,5 cm

ART. 41279 T
↓ 40 ↔ 21 cm

ART. 41280
↓ 50 ↔ 23 cm

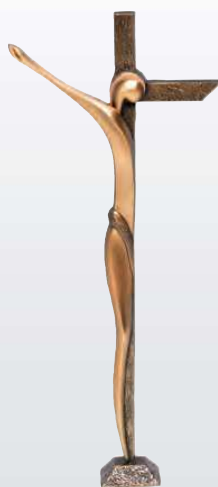

ART. 41276 T
↓ 80 ↔ 36,5 cm



ART. 41136 P
↓ 15 ↔ 6,5 cm
ART. 41137
↓ 20 ↔ 9 cm
ART. 41138
↓ 25 ↔ 11 cm
ART. 41139
↓ 30 ↔ 13 cm
ART. 41140
↓ 40 ↔ 18 cm
ART. 41141
↓ 50 ↔ 21,5 cm



ART. 41142 P
↓ 20 ↔ 9 cm
ART. 41143
↓ 25 ↔ 11 cm
ART. 41144
↓ 30 ↔ 13 cm
ART. 41145
↓ 40 ↔ 18 cm
ART. 41147
↓ 50 ↔ 21,5 cm



ART. 41148 P
↓ 15 ↔ 6,5 cm
ART. 41149
↓ 20 ↔ 9 cm
ART. 41157
↓ 25 ↔ 11 cm
ART. 41158
↓ 30 ↔ 13 cm
ART. 41159
↓ 40 ↔ 18 cm
ART. 41160
↓ 50 ↔ 21,5 cm



- ART. 33010 ↓ 10 ↔ 5 cm P
- ART. 33012 ↓ 12 ↔ 5 cm
- ART. 33015 ↓ 15 ↔ 6 cm
- ART. 33020 ↓ 20 ↔ 6 cm
- ART. 33025 ↓ 25 ↔ 8 cm
- ART. 33030 ↓ 30 ↔ 8 cm
- ART. 33040 ↓ 40 ↔ 10 cm
- ART. 33050 ↓ 50 ↔ 12 cm
- ART. 33060 ↓ 60 ↔ 12 cm
- ART. 33070 ↓ 70 ↔ 12 cm
- ART. 33080 ↓ 80 ↔ 14 cm
- ART. 33090 ↓ 90 ↔ 14 cm
- ART. 33099 ↓ 100 ↔ 14 cm



- ART. 33010SH ↓ 10 ↔ 5 cm P
- ART. 33012SH ↓ 12 ↔ 5 cm
- ART. 33015SH ↓ 15 ↔ 6 cm
- ART. 33020SH ↓ 20 ↔ 6 cm
- ART. 33025SH ↓ 25 ↔ 8 cm
- ART. 33030SH ↓ 30 ↔ 8 cm
- ART. 33030SH ↓ 30 ↔ 8 cm
- ART. 33040SH ↓ 40 ↔ 10 cm
- ART. 33050SH ↓ 50 ↔ 12 cm



- ART. 33215 ↓ 15 ↔ 6 cm P
- ART. 33220 ↓ 20 ↔ 6 cm
- ART. 33225 ↓ 25 ↔ 8 cm
- ART. 33230 ↓ 30 ↔ 8 cm
- ART. 33240 ↓ 40 ↔ 10 cm



ART. 41266 P
↓ 50 ↔ 20 cm



ART. 41256 P
↓ 50 ↔ 20 cm



ART. 41026 P
↓ 45 ↔ 23 cm



ART. 41028 P
↓ 45 ↔ 23 cm



ART. 41025 P
↓ 45 ↔ 23 cm



ART. 41265 P
↓ 40 ↔ 16 cm



ART. 41255 P
↓ 40 ↔ 16 cm

OTIPRINT



- BIANCO
- ART. 41136BI ↓ 15 cm
 - ART. 41137BI ↓ 20 cm
 - ART. 41138BI ↓ 25 cm
 - ART. 41139BI ↓ 30 cm
 - ART. 41140BI ↓ 40 cm
 - ART. 41141BI ↓ 50 cm



- CARRARA
- ART. 41136CA ↓ cm 15
 - ART. 41137CA ↓ cm 20
 - ART. 41138CA ↓ cm 25
 - ART. 41139CA ↓ cm 30
 - ART. 41140CA ↓ cm 40
 - ART. 41141CA ↓ cm 50



- BOTTICINO
- ART. 41136BO ↓ cm 15
 - ART. 41137BO ↓ cm 20
 - ART. 41138BO ↓ cm 25
 - ART. 41139BO ↓ cm 30
 - ART. 41140BO ↓ cm 40
 - ART. 41141BO ↓ cm 50



ART. 41171 ↓ 40 ↔ 18 cm P

ART. 41172 ↓ 50 ↔ 21,5 cm



ART. 41120 ↓ 12 ↔ 5 cm P

ART. 41121 ↓ 15 ↔ 6 cm

ART. 41122 ↓ 20 ↔ 8 cm

ART. 41123 ↓ 25 ↔ 10 cm



ART. 41248 P
 ↓ 12 ↔ 5 cm
 ART. 41249
 ↓ 15 ↔ 6 cm
 ART. 41250
 ↓ 20 ↔ 8 cm
 ART. 41251
 ↓ 25 ↔ 10 cm
 ART. 41252
 ↓ 30 ↔ 13 cm
 ART. 41253
 ↓ 40 ↔ 16 cm
 ART. 41254
 ↓ 50 ↔ 20 cm



ART. 41260 P
 ↓ 20 ↔ 8 cm
 ART. 41261
 ↓ 25 ↔ 10 cm
 ART. 41272
 ↓ 30 ↔ 13 cm
 ART. 41273
 ↓ 40 ↔ 16 cm
 ART. 41274
 ↓ 50 ↔ 20 cm



ART. 41262 P
 ↓ 30 ↔ 13 cm
 ART. 41263
 ↓ 40 ↔ 16 cm
 ART. 41264
 ↓ 50 ↔ 20 cm



ART. 41225 P
 ↓ 30 ↔ 12 cm



ART. 41226 P
 ↓ 40 ↔ 16 cm



ART. 41215 P
 ↓ 30 ↔ 12 cm
 ART. 41216
 ↓ 40 ↔ 16 cm



ART. 41220 P
 ↓ 30 ↔ 12 cm
 ART. 41221
 ↓ 40 ↔ 16 cm



ART. 41205 P
 ↓ 30 ↔ 12 cm
 ART. 41206
 ↓ 40 ↔ 16 cm



ART. 41283 P
 ↓ 40 ↔ 16 cm
 ART. 41284
 ↓ 50 ↔ 20 cm



ART. 41293 P
 ↓ 40 ↔ 16 cm
 ART. 41294
 ↓ 50 ↔ 20 cm



ART. 41282 P
 ↓ 30 ↔ 13 cm



ART. 31426 T
 ↓ 26 ↔ 11 cm



ART. 31438 T
 ↓ 38 ↔ 16 cm



ART. 41005 P
 ↓ 15 ↔ 8 cm
 ART. 41006
 ↓ 20 ↔ 11 cm
 ART. 41007
 ↓ 25 ↔ 14 cm
 ART. 41008
 ↓ 30 ↔ 14 cm

ART. 41000 P
 ↓ 15 ↔ 8 cm
 ART. 41001
 ↓ 20 ↔ 11 cm
 ART. 41002
 ↓ 25 ↔ 14 cm
 ART. 41003
 ↓ 30 ↔ 14 cm

ART. 41027 P
 ↓ 20 ↔ 13 cm

ART. 41018 ↓ 10 ↔ 5 cm P
 ART. 41019 ↓ 20 ↔ 10 cm
 ART. 41023 ↓ 30 ↔ 14 cm
 ART. 41024 ↓ 40 ↔ 16 cm
 ART. 41029 ↓ 50 ↔ 16 cm

ART. 41189 ↓ 10 ↔ 5 cm P
 ART. 41190 ↓ 20 ↔ 10 cm
 ART. 41191 ↓ 30 ↔ 14 cm
 ART. 41192 ↓ 40 ↔ 16 cm
 ART. 41193 ↓ 50 ↔ 16 cm

ART. 41194 ↓ 10 ↔ 5 cm P
 ART. 41195 ↓ 20 ↔ 10 cm
 ART. 41196 ↓ 30 ↔ 14 cm
 ART. 41197 ↓ 40 ↔ 16 cm
 ART. 41198 ↓ 50 ↔ 16 cm



ART. 41038 P
 ↓ 12 ↔ 5,5 cm

ART. 41039 P
 ↓ 20 ↔ 9 cm

ART. 41040 P
 ↓ 12 ↔ 7 cm

ART. 41041 P
 ↓ 20 ↔ 11 cm

ART. 41124 ↓ 10 ↔ 5 cm P
 ART. 41125 ↓ 20 ↔ 10 cm
 ART. 41126 ↓ 30 ↔ 14 cm
 ART. 41127 ↓ 40 ↔ 16 cm
 ART. 41128 ↓ 50 ↔ 16 cm

ART. 41109 ↓ 10 ↔ 5 cm P
 ART. 41110 ↓ 20 ↔ 10 cm
 ART. 41111 ↓ 30 ↔ 14 cm
 ART. 41112 ↓ 40 ↔ 16 cm
 ART. 41113 ↓ 50 ↔ 16 cm

ART. 41129 ↓ 10 ↔ 5 cm P
 ART. 41130 ↓ 20 ↔ 10 cm
 ART. 41131 ↓ 30 ↔ 14 cm
 ART. 41132 ↓ 40 ↔ 16 cm
 ART. 41133 ↓ 50 ↔ 16 cm

CROCI DA TAGLIO LASER



ART. 41237 ↓ 10 cm P
 ART. 41238 ↓ 12 cm
 ART. 41239 ↓ 15 cm
 ART. 41240 ↓ 20 cm
 ART. 41241 ↓ 25 cm

ART. 41242 ↓ 10 cm P
 ART. 41243 ↓ 12 cm
 ART. 41244 ↓ 15 cm
 ART. 41245 ↓ 20 cm
 ART. 41246 ↓ 25 cm

ART. 41227 ↓ 10 cm P
 ART. 41228 ↓ 12 cm
 ART. 41229 ↓ 15 cm
 ART. 41230 ↓ 20 cm
 ART. 41231 ↓ 25 cm

ART. 41232 ↓ 10 cm P
 ART. 41233 ↓ 12 cm
 ART. 41234 ↓ 15 cm
 ART. 41235 ↓ 20 cm
 ART. 41236 ↓ 25 cm

ART. 41100 ↓ 10 ↔ 5 cm P
 ART. 41101 ↓ 20 ↔ 10 cm
 ART. 41102 ↓ 30 ↔ 14 cm
 ART. 41103 ↓ 40 ↔ 16 cm
 ART. 41104 ↓ 50 ↔ 16 cm

In base alla dimensione possono subire variazioni nella forma.

In base alla dimensione possono subire variazioni nella forma.



ART. 32325 ↓ 25 ↔ 17 cm
ART. 32330 ↓ 30 ↔ 22 cm



ART. 32000 ↓ 8 ↔ 3 cm
ART. 32010 ↓ 10 ↔ 4 cm
ART. 32015 ↓ 15 ↔ 5 cm
ART. 32020 ↓ 20 ↔ 7 cm
ART. 32025 ↓ 25 ↔ 8 cm



ART. 32210 ↓ 10 ↔ 9 cm
ART. 32215 ↓ 15 ↔ 13 cm
ART. 32220 ↓ 20 ↔ 17 cm
ART. 32225 ↓ 25 ↔ 21 cm



ART. 32257
↓ 70 ↔ 54 cm



ART. 32256
↓ 50 ↔ 36 cm



ART. 32255
↓ 60 ↔ 45 cm



ART. 32040
↓ 40 ↔ 28 cm



ART. 32241
↓ 80 ↔ 75 cm
CERA PERSA



ART. 32242
↓ 120 ↔ 115 cm
CERA PERSA



ART. 32243
↓ 160 ↔ 149 cm
CERA PERSA

NOVITÀ



ART. 35156
↓ 12 ↔ 6,5 cm



ART. 35157
↓ 16 ↔ 8,5 cm



ART. 35158
↓ 20 ↔ 10,5 cm



ART. 35126
↓ 12 ↔ 9 cm
ART. 35123
↓ 16,5 ↔ 11 cm
ART. 35128
↓ 24 ↔ 16 cm



BIANCO
ART. 35126BI
↓ cm 12 ↔ 6 cm
ART. 35123BI
↓ cm 16,5 ↔ 11 cm
ART. 35128BI
↓ cm 24 ↔ 16 cm



CARRARA
ART. 35126CA
↓ cm 12 ↔ 6 cm
ART. 35123CA
↓ cm 16,5 ↔ 11 cm
ART. 35128CA
↓ cm 24 ↔ 16 cm



BOTTICINO
ART. 35126BO
↓ cm 12 ↔ 6 cm
ART. 35123BO
↓ cm 16,5 ↔ 11 cm
ART. 35128BO
↓ cm 24 ↔ 16 cm

OTIPRINT



ART. 35411
↓ 12,5 ↔ 8 cm



ART. 35412
↓ 17 ↔ 10,5 cm



ART. 35413
↓ 25 ↔ 16 cm



ART. 35118
↓ 15 ↔ 12 cm
fusione a terra



ART. 35041
↓ 19 ↔ 13 cm
fusione a terra



ART. 35024
↓ 20 ↔ 14 cm
fusione a terra



ART. 35017
↓ 21 ↔ 16,6 cm
fusione a terra



ART. 35020
↓ 13 ↔ 8 cm



ART. 35022
↓ 17,5 ↔ 10,5 cm



ART. 35023
↓ 27 ↔ 16 cm



ART. 35106
↓ 12 ↔ 6 cm
ART. 35107
↓ 18 ↔ 9 cm



ART. 35030
↓ 27 ↔ 20 cm



ART. 35051
↓ 26 ↔ 22 cm
fusione a terra



ART. 35035
↓ 33 ↔ 22 cm
fusione a terra



ART. 35028
↓ 30 ↔ 7,5 cm



Statua
ART. 48075 terreno
↓ 30 ↔ 7,5 cm



Statua
ART. 48076 parete
↓ 30 ↔ 7,5 cm

NOVITÀ



ART. 35161
↓ 11,5 ↔ 6,5 cm



ART. 35162
↓ 16 ↔ 8,5 cm



ART. 35163
↓ 19,5 ↔ 10,5 cm



ART. 35049
↓ 36 ↔ 26 cm
fusione a terra



Madonna del Carmine
ART. 35027
↓ 35 ↔ 18 cm



Madonna del Carmine
ART. 35026
↓ 38 ↔ 17 cm



ART. 35063
↓ 13,5 ↔ 8,5 cm



ART. 35064
↓ 18 ↔ 11,5 cm



ART. 35068
↓ 27 ↔ 17 cm

OTIPRINT



ART. 48541
↓ 43 ↔ 30 cm
fusione a terra



ART. 35046
↓ 25,5 ↔ 19,5 cm
fusione a terra



Busto
• ART. 48202
↓ 32 ↔ 28 cm
fusione a terra



ART. 35127
↓ 12 ↔ 9 cm
ART. 35124
↓ 16,5 ↔ 11 cm
ART. 35129
↓ 24 ↔ 16 cm



BIANCO
ART. 35127BI
↓ cm 12 ↔ 9 cm
ART. 35124BI
↓ cm 16,5 ↔ 11 cm
ART. 35129BI
↓ cm 24 ↔ 16 cm



CARRARA
ART. 35127CA
↓ cm 12 ↔ 9 cm
ART. 35124CA
↓ cm 16,5 ↔ 11 cm
ART. 35129CA
↓ cm 24 ↔ 16 cm



BOTTICINO
ART. 35127BO
↓ cm 12 ↔ 9 cm
ART. 35124BO
↓ cm 16,5 ↔ 11 cm
ART. 35129BO
↓ cm 24 ↔ 16 cm



ART. 35105
↓ 9 ↔ 12 cm



ART. 35114
↓ 15 ↔ 13 cm



ART. 35067
↓ 17 ↔ 13 cm



ART. 35042
↓ 19 ↔ 13 cm
fusione a terra



ART. 35034
↓ 33 ↔ 22 cm
fusione a terra



ART. 48508
↓ 35 ↔ 25 cm
fusione a terra



Cristo nazareno
ART. 35039
↓ 35 ↔ 27,5 cm



ART. 35025
↓ 20 ↔ 14 cm
fusione a terra



ART. 35099
↓ 24 ↔ 16 cm



ART. 35045
↓ 25,5 ↔ 19,5 cm
fusione a terra



ART. 35048
↓ 36 ↔ 26 cm
fusione a terra



ART. 48540
↓ 47 ↔ 30 cm
fusione a terra



ART. 35016
↓ 21 ↔ 16,6 cm
fusione a terra



ART. 35052
↓ 26 ↔ 20 cm
fusione a terra



ART. 35031
↓ 27 ↔ 20 cm



ART. 48205
↓ 41 ↔ 33 ↔ 21 cm
fusione a terra

**BUSTI
CRISTO**



ART. 48208
↓ 41 ↔ 33 ↔ 21 cm
fusione a terra

NOVITÀ



ART. 35164
↓ 12,5 ↔ 8 cm



ART. 35165
↓ 17 ↔ 11 cm



ART. 35166
↓ 20 ↔ 13 cm



ART. 35032
↓ 27 ↔ 30 cm



ART. 35018
↓ 27 ↔ 22,5 cm
fusione a terra



ART. 35044
↓ 32,5 ↔ 22 cm
fusione a terra

OTIPRINT



ART. 35078
↓ 13 ↔ 13 cm
ART. 35079
↓ 17 ↔ 17 cm
ART. 35080
↓ 24 ↔ 26 cm



BIANCO
ART. 35078BI
↓ cm 13 ↔ 13 cm
ART. 35079BI
↓ cm 17 ↔ 17 cm
ART. 35080BI
↓ cm 24 ↔ 26 cm



CARRARA
ART. 35078CA
↓ cm 13 ↔ 13 cm
ART. 35079CA
↓ cm 17 ↔ 17 cm
ART. 35080CA
↓ cm 24 ↔ 26 cm



BOTTICINO
ART. 35078BO
↓ cm 13 ↔ 13 cm
ART. 35079BO
↓ cm 17 ↔ 17 cm
ART. 35080BO
↓ cm 24 ↔ 26 cm



ART. 35047
↓ 33 ↔ 25,5 cm
fusione a terra



ART. 35053
↓ 32 ↔ 31,5 cm
fusione a terra



ART. 35043
↓ 22,5 ↔ 12,5 cm
fusione a terra



ART. 35081
↓ 14,5 ↔ 10,5 cm
ART. 35082
↓ 19 ↔ 14 cm
ART. 35083
↓ 28,5 ↔ 21 cm



ART. 35055
↓ 32 ↔ 24 cm
fusione a terra



ART. 35050
↓ 44 ↔ 37 cm
fusione a terra

PARTICOLARE **PIETÀ**



ART. 48529
 ↓ 48 ↔ 13 cm
 fusione a terra



ART. 48542
 ↓ 49 ↔ 49 cm
 fusione a terra



ART. 48532
 ↓ 51 ↔ 30 cm
 ART. 48539
 ↓ 34 ↔ 19 cm
 fusione a terra



ART. 48537
 ↓ 50 ↔ 37 cm
 fusione a terra



Papa Wojtyla
 ART. 35084
 ↓ 12,5 ↔ 11 cm
 fusione a terra



Papa Wojtyla
 ART. 35085
 ↓ 17,5 ↔ 15 cm
 fusione a terra



Papa Wojtyla
 ART. 35086
 ↓ 25,5 ↔ 22 cm
 fusione a terra



Papa Wojtyla
 ART. 35087
 ↓ 15 ↔ 11 cm



Papa Wojtyla
 ART. 35088
 ↓ 20 ↔ 15 cm



Papa Wojtyla
 ART. 35089
 ↓ 26,5 ↔ 19,5 cm



Targa S. Francesco da Paola
 ART. 35406
 ↓ 18 ↔ 12,5 cm
 fusione a terra



Medaglione Papa Giovanni XXIII
 ART. 35410
 ↓ 20,5 ↔ 17 cm
 fusione a terra



Medaglione S. Antonio
 ART. 35033
 ↓ 21 ↔ 13 cm



Medaglione Santa Rita
 ART. 35029
 ↓ 22 ↔ 13 cm
 fusione a terra



Padre Pio
ART. 35057
↓ 12,5 ↔ 12 cm
ART. 35058
↓ 17,5 ↔ 17 cm
ART. 35059
fusione a terra
↓ 22 ↔ 22 cm



Padre Pio
ART. 35056
↓ 20 ↔ 18 cm
fusione a terra



ART. 35010
↓ 8,5 ↔ 4 cm
ART. 35011
↓ 12 ↔ 6 cm
ART. 35012
↓ 17 ↔ 7,5 cm
fusione a terra



ART. 35013
↓ 8,5 ↔ 4 cm
ART. 35014
↓ 12 ↔ 6 cm
ART. 35015
↓ 17 ↔ 8 cm
fusione a terra



Ultima cena
ART. 35096
↓ 8 ↔ 24 cm



Padre Pio
ART. 35061
↓ 34 ↔ 34 cm
fusione a terra



Busto Padre Pio
ART. 48203
↓ 42 ↔ 34 ↗ 30 cm
fusione cera persa



ART. 35404
↓ 7,5 ↔ 12 cm
fusione a terra



ART. 35091
↓ 8 ↔ 8 cm

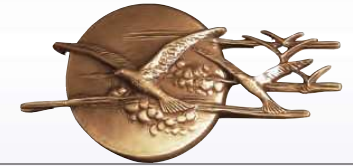

ART. 35090
↓ 8 ↔ 15,5 cm



Med. San Giuseppe
ART. 35037
↓ 39,5 ↔ 13,5 cm



Med. Sant'Antonio
ART. 35036
↓ 40,5 ↔ 13 cm



Med. Sacro Cuore
ART. 35038
↓ 43 ↔ 17 cm



Targa Vergine del Pilar
ART. 35040
↓ 43 ↔ 23 cm



Targa nonno con bambino
ART. 35402
↓ 10 ↔ 10 cm
fusione a terra



Applicazioni mani giunte con fissaggio viti
ART. 35097 ↓ 10 ↔ 8 cm
con biadesivo
ART. 35098 ↓ 10 ↔ 8 cm



ART. 35092
↓ 10 ↔ 7 cm



ART. 35093
↓ 10 ↔ 11,5 cm



Targa gioco bocce
ART. 35403
↓ 10,5 ↔ 13 cm
fusione a terra



Targa caminetto
ART. 35405
↓ 12,5 ↔ 11 cm
fusione a terra



Deposizione
ART. 48538
↓ 31 ↔ 50 cm
fusione a terra



ART. 35125
↓ 16,5 ↔ 10 cm



ART. 35094
↓ 15 ↔ 12,5 cm



ART. 35095
↓ 18 ↔ 10 cm



Ultima Cena
ART. 48502
↓ 35 ↔ 100 cm
fusione a terra



Targa angelo sx
ART. 35401
↓ 20 ↔ 13 cm
fusione a terra



Targa angelo dx
ART. 35400
↓ 20 ↔ 13 cm
fusione a terra



ART. 35021
↓ 32 ↔ 20 cm
fusione a terra



Cristo
ART. 38854
↓ 40 ↔ 37 cm
fusione cera persa



Particolare Pietà
ART. 38860
↓ 45 ↔ 40 cm
fusione cera persa



ART. 38455
↓ 10 ↔ 22 cm



ART. 38454
↓ 13 ↔ 19 cm



ART. 38453
↓ 14 ↔ 16 cm



Deposizione
ART. 38852
↓ 45 ↔ 80 cm
fusione cera persa



Particolare Pietà
ART. 48520
↓ 60 ↔ 45 cm
fusione a terra



Pietà
ART. 48522
↓ 65 ↔ 50 cm
fusione a terra



Crocefissione
ART. 38859
↓ 55 ↔ 40 cm
fusione a terra



Crocefissione
ART. 48543
↓ 50 ↔ 40 cm
fusione a terra



Crocefisso
ART. 38833
↓ 57 ↔ 43 cm
fusione a terra



Targa
ART. 48544
↓ 64 ↔ 44 cm
fusione a terra

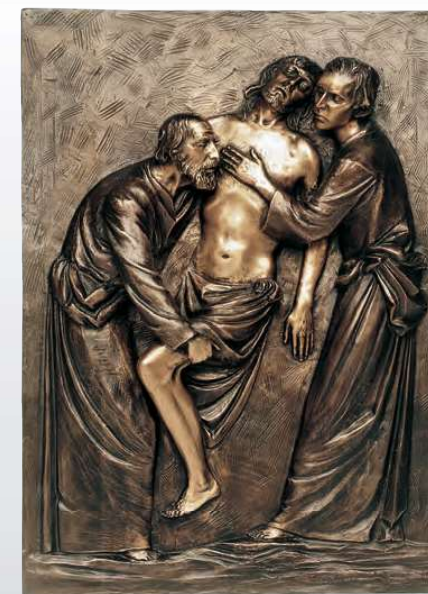

Deposizione
ART. 48580
↓ 70 ↔ 50 cm
fusione cera persa



Resurrezione
ART. 48525
↓ 75 ↔ 100 cm
fusione a terra



Sacra Famiglia
ART. 38831
↓ 80 ↔ 120 cm
fusione a terra



Resurrezione
ART. 38853
↓ 77 ↔ 85 cm
fusione cera persa



Resurrezione
ART. 38856
↓ 80 ↔ 40 cm
fusione cera persa



Sacra Famiglia
ART. 48581
↓ 95 ↔ 30 cm
fusione cera persa



Crocefissione
ART. 38832
↓ 110 ↔ 110 cm
fusione a terra



Deposizione
ART. 38861
↓ 100 ↔ 60 cm
fusione cera persa



ART. 48070
↓ 29 ↔ 9 cm



ART. 48075
↓ 30 ↔ 7,5 cm



ART. 48076
↓ 30 ↔ 7,5 cm



ART. 48077
↓ 40 ↔ 12,5 12 cm



ART. 48174
↓ 40 ↔ 15 cm



ART. 48200
↓ 41,5 ↔ 14,5 8 cm



ART. 48091
↓ 45 ↔ 26 ↗ 39 cm



ART. 48020
↓ 45 ↔ 23 ↗ 34 cm



ART. 48101
↓ 45 ↔ 30 ↗ 20 cm
fusione cera persa



ART. 48172
↓ 45 ↔ 23 ↗ 29 cm



ART. 48042
↓ 45 ↔ 23 ↗ 34 cm



ART. 48041
↓ 45 ↔ 26 ↗ 39 cm



ART. 48189
↓ 46 ↔ 20 cm



ART. 48194
↓ 46 ↔ 20 cm



ART. 48071
↓ 49 ↔ 14 ↗ 12 cm



ART. 48177
↓ 60 ↔ 22 cm



ART. 48178
↓ 67 ↔ 22 cm



ART. 48182
↓ 60 ↔ 22 cm



ART. 48165
↓ 60 ↔ 21 cm



ART. 48087
↓ 60 ↔ 18.5 18 cm



ART. 38213
↓ 65 ↔ 14.5 12 cm



Manto colorato
ART. 48193
↓ 60 ↔ 22 cm



ART. 48180
↓ 60 ↔ 22 cm



ART. 48053
↓ 65 ↔ 30.5 37 cm
fusione cera persa



ART. 48054
↓ 65 ↔ 40.5 37 cm
fusione cera persa



ART. 48146
↓ 63 ↔ 28 cm
fusione cera persa



finitura blues
ART. 48034
↓ 63 ↔ 28 cm
fusione cera persa



finitura folk
ART. 48160
↓ 63 ↔ 28 cm
fusione cera persa



ART. 48149
↓ 64,5 ↔ 20 cm
fusione cera persa



ART. 48150
↓ 64 ↔ 18,5 cm
fusione cera persa



ART. 38287
↓ 80 ↔ 35
fusione cera persa



ART. 48147
↓ 63 ↔ 22,5 cm
fusione cera persa



finitura blues
ART. 48033
↓ 63 ↔ 22,5 cm
fusione cera persa



finitura folk
ART. 48159
↓ 63 ↔ 22,5 cm
fusione cera persa



ART. 48060
↓ 80 ↔ 25 ↗ 20 cm
fusione cera persa



ART. 48066
↓ 85 ↔ 25 ↗ 16 cm



ART. 48065
↓ 85 ↔ 33 ↗ 23 cm



ART. 38259
↓ 75 ↔ 76 ↗ 55 cm
fusione cera persa

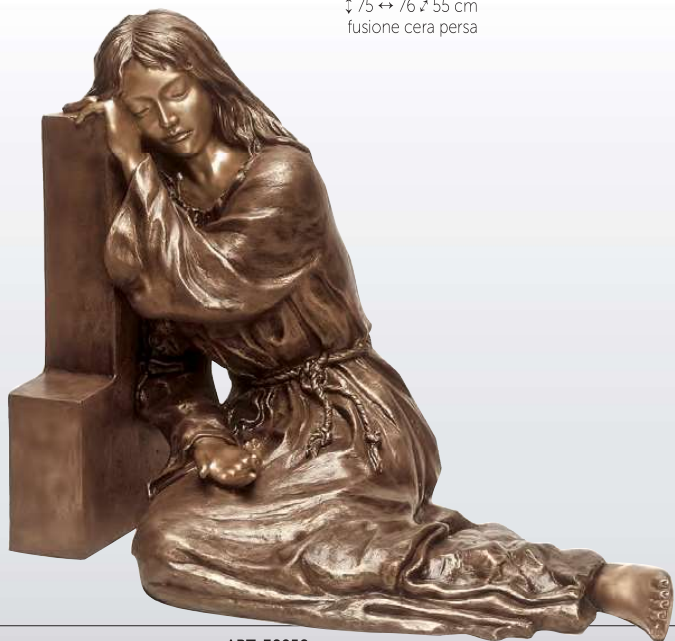

ART. 38258
↓ 80 ↔ 100 ↗ 60 cm
fusione cera persa



ART. 48050
↓ 100 ↔ 25 ↗ 24 cm
fusione cera persa



ART. 38288
↓ 105 ↔ 50 ↗ 30 cm
fusione cera persa



ART. 48119
↓ 110 ↔ 35 ↗ 32 cm
fusione cera persa



ART. 48052
↓ 100 ↔ 55 cm
fusione cera persa



ART. 48141
↓ 108 ↔ 55 ↗ 60 cm
fusione cera persa



ART. 38276
↓ 112 ↔ 53 cm
fusione cera persa



ART. 48069
↓ 110 ↔ 53 cm
fusione cera persa



Madonna di Lourdes
ART. 48116
↓ 80 ↔ 20 ↗ 20 cm
ART. 48117
↓ 110 ↔ 35 ↗ 30 cm
ART. 48118
↓ 150 ↔ 45 ↗ 42 cm
fusione cera persa



ART. 48055
↓ 105 ↔ 25 ↗ 25 cm
fusione cera persa



ART. 38289
↓ 125 ↔ 50
fusione cera persa



ART. 38253
↓ 125 ↔ 40 ↗ 60 cm
fusione cera persa



Madonna
ART. 38251
↓ 155 ↔ 40 ↗ 35 cm
fusione cera persa



Madonna
ART. 38290
↓ 175 ↔ 72, ↑ 53 cm
fusione cera persa



Madonna con Bambino
ART. 48135
↓ 185 ↔ 74, ↑ 49 cm
fusione cera persa



ART. 48080
↓ 29 ↔ 9 cm



ART. 48078
↓ 40 ↔ 16, ↑ 13 cm



ART. 48081
↓ 49 ↔ 14, ↑ 13 cm



ART. 48181
↓ 60 ↔ 22 cm



Manto colorato
ART. 48192
↓ 60 ↔ 22 cm



ART. 48166
↓ 60 ↔ 20 cm

CRISTO

CRISTO



ART. 48088
 † 60 ↔ 22 † 17 cm
 ART. 48096
 † 80 ↔ 34 † 26 cm

finitura colorata
 ART. 48045
 † 60 ↔ 22 † 17 cm

ART. 48151
 † 64 ↔ 26 cm
 fusione cera persa

ART. 38279
 † 75 ↔ 38 † 20 cm
 fusione cera persa

ART. 38275
 † 80 ↔ 25 † 20 cm
 fusione cera persa



ART. 48148
 † 62,5 ↔ 29,5 cm
 fusione cera persa

finitura folk
 ART. 48161
 † 62,5 ↔ 29,5 cm
 fusione cera persa

finitura blues
 ART. 48024
 † 62,5 ↔ 29,5 cm
 fusione cera persa

ART. 48067
 † 84 ↔ 23 † 16 cm

ART. 48068
 † 85 ↔ 45 † 29 cm



ART. 48106
↓ 100 ↔ 40 ↗ 60 cm
fusione cera persa



ART. 48140
↓ 104 ↔ 73 ↗ 81 cm
fusione cera persa



ART. 48120
↓ 110 ↔ 45 ↗ 32 cm
fusione cera persa



ART. 32244 **P**
↓ 108 ↔ 73 cm

ART. 32245 **T**
↓ 108 ↔ 73 cm
fusione cera persa



ART. 48100
↓ 110 ↔ 40 ↗ 60 cm
fusione cera persa



ART. 48138
↓ 115 ↔ 55 ↗ 47 cm
fusione cera persa



ART. 48137
↓ 120 ↔ 49 ↗ 70 cm
fusione cera persa



ART. 48105
↓ 125 ↔ 85 ↗ 90 cm
fusione cera persa



ART. 48139
↓ 140 ↔ 50 ↗ 165 cm
fusione cera persa



ART. 48114
↓ 136 ↔ 74 ↑ 41 cm
fusione cera persa



ART. 38250
↓ 140 ↔ 55 cm
fusione cera persa



ART. 48113
↓ 145 ↔ 60 ↑ 55 cm
ART. 48154
↓ 119 ↔ 41 ↑ 39 cm
fusione cera persa



ART. 38256
↓ 160 ↔ 48 ↑ 65 cm
fusione cera persa



ART. 48107
↓ 180 ↔ 90 cm
fusione cera persa



ART. 38220
↓ 55 ↔ 45 ↗ 35 cm
fusione cera persa



ART. 48124
↓ 45 ↔ 43 cm
fusione cera persa



ART. 48142
↓ 56 ↔ 67 ↗ 31 cm
fusione cera persa



ART. 48015
↓ 52 ↔ 36 ↗ 18,5 cm



ART. 48123
 † 63 ↔ 60 † 32 cm
 fusione cera persa

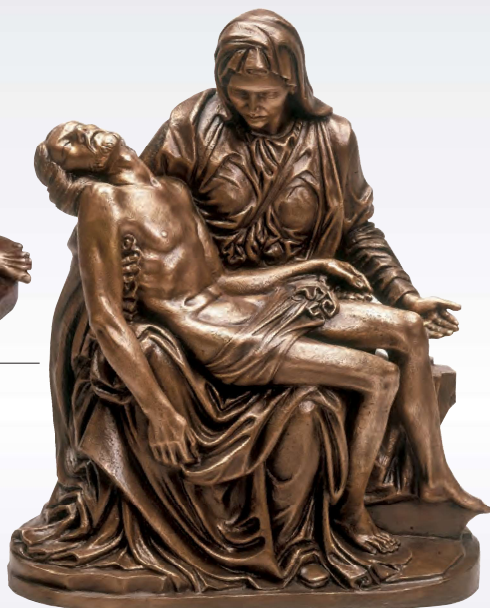

ART. 48001
 † 70 ↔ 60 † 27 cm
 fusione cera persa



ART. 48084
 † 74 ↔ 53 † 33 cm
 fusione cera persa



ART. 38291
 † 85 ↔ 80 † 55 cm
ART. 38292
 † 95 ↔ 100 cm
 fusione cera persa



ART. 38255
 † 80 ↔ 110 cm
 Pietà con base
ART. 38257
 † 90 ↔ 110 cm
 fusione cera persa



ART. 48000
 ↓ 85 ↔ 70 ↗ 40 cm
 fusione cera persa



ART. 48129
 ↓ 180 cm
 fusione cera persa



Gettafiori
ART. 48196
 ↓ 40 ↔ 15 cm
 fusione cera persa



finitura folk
ART. 48157
 ↓ 40 ↔ 15 cm
 fusione cera persa



finitura blues
ART. 48164
 ↓ 40 ↔ 15 cm
 fusione cera persa



Gettafiori con ali
ART. 48197
 ↓ 46 ↔ 15 cm
 fusione cera persa



finitura folk
ART. 48158
 ↓ 46 ↔ 15 cm
 fusione cera persa



finitura blues
ART. 48171
 ↓ 46 ↔ 15 cm
 fusione cera persa



ART. 48102
↓ 47 ↔ 20 cm
fusione cera persa



ART. 48188
↓ 53 ↔ 20 cm



ART. 48195
↓ 53 ↔ 20 cm



ART. 48199
↓ 66 ↔ 21,5 cm
fusione cera persa



finitura blues
ART. 48163
↓ 66 ↔ 21,5 cm
fusione cera persa



ART. 48198
↓ 60 ↔ 21,5 cm
fusione cera persa



finitura folk
ART. 48155
↓ 60 ↔ 21,5 cm
fusione cera persa



finitura blues
ART. 48162
↓ 60 ↔ 21,5 cm
fusione cera persa



finitura folk
ART. 48156
↓ 66 ↔ 21,5 cm
fusione cera persa



ART. 48109
↑ 90 ↔ 40 ↓ 65 cm
fusione cera persa



ART. 48110
↑ 80 ↔ 40 ↓ 65 cm
fusione cera persa



parete
ART. 48122
↑ 110 ↔ 50 ↓ 13 cm
fusione cera persa



ART. 48098
↑ 115 ↔ 59 ↓ 14 cm
fusione cera persa



ART. 48025
↑ 147 ↔ 34 ↓ 56 cm base 34x56 cm
fusione cera persa



ART. 38254
↓ 135 ↔ 25 cm
fusione cera persa



ART. 48005
base 45x45 cm
↓ 210 ↔ 127 ↗ 120 cm
fusione cera persa



finitura blues
ART. 48006
base 45x45 cm
↓ 210 ↔ 127 ↗ 120 cm
fusione cera persa



finitura folk
ART. 48007
base 45x45 cm
↓ 210 ↔ 127 ↗ 120 cm
fusione cera persa

S. ANTONIO



Aquila
ART. 48206
↓ 29 ↔ 60, 22 cm
fusione cera persa

Aquila
ART. 48207
↓ 42 ↔ 105, 24 cm
fusione cera persa



Statua S. Teresa
ART. 48169
↓ 60 ↔ 17 cm



S. Giuseppe
ART. 48179
↓ 63 ↔ 23 cm



Santa Barbara
ART. 38246
↓ 75 ↔ 30, 20 cm
fusione cera persa



Madonna del Carmine
ART. 48086
↓ 80 ↔ 25, 20 cm
fusione cera persa



ART. 38293
↓ 60 ↔ 20 cm
fusione cera persa



ART. 38294
↓ 80 ↔ 25 cm
fusione cera persa



ART. 38296
↓ 159 ↔ 52, 55 cm
fusione cera persa



ART. 48173
↓ 61 ↔ 21 cm base Ø 16 cm



ART. 38295
↓ 120 ↔ 40 cm
fusione cera persa



ART. 48170
 ↓ 60 ↔ 19 cm



ART. 48027
 ↓ 140 ↔ 44 cm
 base 39x33 cm
 fusione cera persa



ART. 48026
 ↓ 80 ↔ 26 cm base 24x20 cm
 fusione cera persa



ART. 48031
 ↓ 180 ↔ 54 ↗ 61 cm
 fusione cera persa



Papa Giovanni XXIII
 ART. 48143
 ↓ 65 ↔ 26 ↗ 13 cm
 fusione cera persa



San Francesco
 ART. 48127
 ↓ 108 ↔ 35 ↗ 42 cm
 fusione cera persa



Buon Pastore
 ART. 48134
 ↓ 127 ↔ 46 ↗ 32 cm
 fusione cera persa



Papa Wojtyła
ART. 48153
↑ 215 ↔ 110 cm
base 59x55 cm
fusione cera persa



Papa Wojtyła
ART. 48152
↑ 75 ↔ 19 cm
base 19,5x19 cm
fusione cera persa



San Francesco da Paola
ART. 48145
↑ 178 ↔ 67 ↗ 51 cm
fusione cera persa



Anime in volo
ART. 48132
↑ 172 ↔ 95 ↗ 100 cm
fusione cera persa

TRATTAMENTO ZEUS

Il trattamento **ZEUS**, sfruttando la nanotecnologia, crea uno strato inattaccabile da qualsiasi agente esterno, garantendovi

- ▶ DURATA
- ▶ QUALITÀ
- ▶ PROTEZIONE

*Corsivo
Vezzani*

Con l'applicazione della nostra vernice in polvere, la resa del rivestimento e l'effetto nel tempo creati dal trattamento **ZEUS**, aumentano notevolmente per darvi un prodotto che rimane invariato negli anni.



Grazie al nuovo **TRATTAMENTO ZEUS** vi offriamo un prodotto migliorato, resistente e inalterabile nel tempo

- ANTIGRAFFIO •
- ANTICORROSIONE •
- RESISTENZA TERMICA •
- PROTEZIONE DA AGENTI ESTERNI •

Come avviene la protezione dei materiali grazie a queste particelle? Sfruttando la nanotecnologia.

La densità di atomi che i materiali hanno sulla loro superficie è maggiore rispetto al normale: questo influenza e migliora proprietà come la potenza, la resistenza al calore e la durezza. Le nano particelle si dispongono sulla superficie e formano una barriera protettiva invisibile. La superficie quindi risulterà assolutamente inattaccabile da qualsiasi contaminazione esterna. Le particelle del trattamento Zeus, disponendosi nel modo ottimale, garantiscono lo strato protettivo.



Disposizione Molecole Classica



Disposizione Trattamento Zeus

Corsivo Universal

A B C D E F G a b c d e f g h i
 H I J K L M N j k l m n o p q r
 O P Q R S T U s e t u v w x y
 V W X Y Z 1 2 3 4 5 6 7 8 9 0 ☆ †

13 11 2089
 12 12 1863

IL CORSIVO UNIVERSAL PUO' ESSERE RICHIESTO:

COMPRESSO

Universal

STANDARD

Universal

ALLARGATO

Universal

LE DATE POSSONO ESSERE RICHIESTE:

INCORPORATE NELL'ASTA

13 11 2089

APPOGGIATE NELL'ASTA

12 12 1863

SE AL MOMENTO DELL'ORDINE NON VIENE EFFETTUATA ALCUNA SPECIFICAZIONE, IL CORSIVO VIENE PRODOTTO AUTOMATICAMENTE STANDARD E CON DATE INCORPORATE NELL'ASTA.

ART. 6170 Lettere/Numeri ↓ mm 15 spessore mm 3

ART. 6171 Lettere/Numeri ↓ mm 20 spessore mm 4

ART. 6172 Lettere/Numeri ↓ mm 25 spessore mm 4

ART. 6173 Lettere/Numeri ↓ mm 30 spessore mm 4

ART. 6174 Lettere/Numeri ↓ mm 40 spessore mm 4

ART. 6175 Lettere/Numeri ↓ mm 50 spessore mm 4

ART. 6176 Lettere/Numeri ↓ mm 60 spessore mm 4

ART. 6178 Lettere/Numeri ↓ mm 80 spessore mm 4

ART. 6179 Lettere/Numeri ↓ mm 100 spessore mm 4

Finitura

| | | | |
|--------|-------|--------------|-------|
| SHADOW | + 20% | RIFLESSI | + 20% |
| YELLOW | + 20% | PATINA SCURA | + 20% |
| BIANCO | + 10% | ASTER | + 60% |
| ORO | + 60% | OTIPRINT | + 60% |

Punteggiatura gratuita fino al mm. 50
 Lettere e Numeri sciolti: aumento del 20%

- È possibile richiedere il carattere Corsivo Universal di qualsiasi misura, previo preventivo.
- I numeri sono da intendersi su barretta se non diversamente specificato al momento dell'ordine.
- Negli ordini citare sempre l'altezza delle lettere minuscole a corpo semplice (a-c-m-etc...).
- Le lettere maiuscole hanno un'altezza superiore alle lettere minuscole del 100% circa e vengono conteggiate allo stesso prezzo delle lettere minuscole.
- L'altezza delle date indica sempre il numero con asta compresa.

Free punctuation up to 50 mm.

Loose letters and numbers: 20% increase

- It is possible to ask for the font Universal italics in any size, after a price estimate.
- The numbers are to be meant on underscore of not differently specified at the order.
- In the orders always indicate the height of the lower-case letters in simple type size (a-c-m-etc...).
- The upper case letters are higher by about 100% than the lower-case letters, and are counted in the same way as the lower-case letters.
- The height of the dates are always indicated number included underscore.

Corsivo Plus

A B C D E F G a b c d e f g h i
 H I J K L M N n j k l m n o p q r
 O P Q R S T U s e t u v w x z
 V W X Y Z 1 2 3 4 5 6 7 8 9 0 * †

13 11 2089
 12 12 1863

IL CORSIVO PLUS PUO' ESSERE RICHIESTO:

COMPRESSO
 Plus
 STANDARD
 Plus
 ALLARGATO
 Plus

LE DATE POSSONO ESSERE RICHIESTE:

INCORPORATE NELL'ASTA
 13 11 2089
 APPOGGIATE NELL'ASTA
 12 12 1863

SE AL MOMENTO DELL'ORDINE NON VIENE EFFETTUATA ALCUNA SPECIFICAZIONE, IL CORSIVO VIENE PRODOTTO AUTOMATICAMENTE STANDARD E CON DATE INCORPORATE NELL'ASTA.

| | | |
|-----------|-------------------------|---------------|
| ART. 6200 | Lettere/Numeri ↓ mm 15 | spessore mm 3 |
| ART. 6201 | Lettere/Numeri ↓ mm 20 | spessore mm 3 |
| ART. 6203 | Lettere/Numeri ↓ mm 25 | spessore mm 3 |
| ART. 6204 | Lettere/Numeri ↓ mm 30 | spessore mm 3 |
| ART. 6205 | Lettere/Numeri ↓ mm 40 | spessore mm 3 |
| ART. 6206 | Lettere/Numeri ↓ mm 50 | spessore mm 3 |
| ART. 6207 | Lettere/Numeri ↓ mm 60 | spessore mm 3 |
| ART. 6208 | Lettere/Numeri ↓ mm 80 | spessore mm 3 |
| ART. 6210 | Lettere/Numeri ↓ mm 100 | spessore mm 3 |

| Finitura | | RIFLESSI | |
|----------|-------|--------------|-------|
| SHADOW | + 20% | PATINA SCURA | + 20% |
| YELLOW | + 20% | ASTER | + 60% |
| BIANCO | + 10% | OTIPRINT | + 60% |
| ORO | + 60% | | |

Punteggiatura gratuita fino al mm. 50

Lettere e Numeri sciolti: aumento del 20%

- È possibile richiedere il carattere Corsivo Plus di qualsiasi misura, previo preventivo.
- I numeri sono da intendersi su barretta se non diversamente specificato al momento dell'ordine.
- Negli ordini citare sempre l'altezza delle lettere minuscole a corpo semplice (a-c-m-etc...).
- Le lettere maiuscole hanno un'altezza superiore alle lettere minuscole del 100% circa e vengono conteggiate allo stesso prezzo delle lettere minuscole.
- L'altezza delle date indica sempre il numero con asta compresa.

Free punctuation up to 50 mm.

Loose letters and numbers: 20% increase

- It is possible to ask for the font Plus italics in any size, after a price estimate
- The numbers are to be meant on underscore of not differently specified at the order.
- In the orders always indicate the height of the lower-case letters in simple type size (a-c-m-etc...).
- The upper case letters are higher by about 100% than the lower-case letters, and are counted in the same way as the lower-case letters.
- The height of the dates are always indicated number included underscore.

PRIMARIA LEGA PATINATA BRONZO

Corsivo Plus S

Corsivo Boutique

A B C D E F G
H I J K L M N
O P Q R S T U
V W X Y Z

a b c d e f g h i
j k l m n o p q r
s t u v w x z
1 2 3 4 5 6 7 8 9 0 ☆ †

ART. 6211 Lettere/Numeri ↓ mm 20 spessore mm 6

ART. 6212 Lettere/Numeri ↓ mm 25 spessore mm 6

ART. 6213 Lettere/Numeri ↓ mm 30 spessore mm 6

ART. 6214 Lettere/Numeri ↓ mm 40 spessore mm 6

| Finitura | | | |
|----------|-------|--------------|-------|
| SHADOW | + 20% | RIFLESSI | + 20% |
| YELLOW | + 20% | PATINA SCURA | + 20% |
| BIANCO | + 10% | ASTER | + 60% |
| ORO | + 60% | OTIPRINT | + 60% |

Il corsivo PLUS S può essere richiesto: SOLO STANDARD
The PLUS S may be required: ONLY STANDARD

- Date con numeri sciolti = aumento del 20%
Punteggiatura gratuita fino al mm 50
- Negli ordini citare sempre l'altezza delle lettere minuscole a corpo semplice (a-c-m...).
 - Le lettere maiuscole hanno un'altezza superiore del 100% circa e vengono conteggiate come le minuscole.
 - L'altezza delle date indica sempre il numero con asta compresa.

LE DATE POSSONO ESSERE RICHIESTE:

INCORPORATE NELL'ASTA

13 11 2089

APPOGGIATE NELL'ASTA

12 12 1863

SE AL MOMENTO DELL'ORDINE NON VIENE EFFETTUATA ALCUNA SPECIFICAZIONE, IL CORSIVO VIENE PRODOTTO AUTOMATICAMENTE STANDARD E CON DATE INCORPORATE NELL'ASTA.

- Free punctuation up to 50 mm.
Loose letters and numbers: 20% increase
- The numbers are to be meant on underscore of not differently specified at the order.
 - In the orders always indicate the height of the lower-case letters in simple type size (a-c-m-etc...).
 - The upper case letters are higher by about 100% than the lower-case letters, and are counted in the same way as the lower-case letters.
 - The height of the dates are always indicated number included underscore.

ART. 6224 Lettere/Numeri ↓ mm 20 spessore mm 6

ART. 6229 Lettere/Numeri ↓ mm 25 spessore mm 6

ART. 6234 Lettere/Numeri ↓ mm 30 spessore mm 6

ART. 6244 Lettere/Numeri ↓ mm 40 spessore mm 6

Bon

- Le date possono essere: incorporate - appoggiate - sciolte.
- I numeri si intendono su barretta.
- Per lettere e numeri singoli aumento del 20%
- Negli ordini citare sempre l'altezza delle lettere a corpo semplice (a-c-m-r).
- Le lettere maiuscole hanno un'altezza doppia delle lettere minuscole e vengono conteggiate allo stesso prezzo delle lettere minuscole.
- Punteggiatura gratuita fino al mm 40
- L'altezza delle date indica sempre il numero con asta compresa.

- The numbers can be requested: on underscore - incorporated - single.
- The numbers are to be meant on underscore if not differently specified at the order.
- For single letters and numbers: increase 20%.
- In the orders always indicate the height of the lower-case letters in simple type size (a-c-m, etc...).
- Capital letters are double of small letters; they have the same price.
- Free punctuation up to mm 40
- The height of the dates are always indicated number included underscore.

A B C D E F G a b c d e f g h i
H I J K L M N j k l m n o p q r
O P Q R S T U s t u v w x z
V W X Y Z 1 2 3 4 5 6 7 8 9 0 ☆ †



SINUOSO COME LE DUNE
DI UN GRANDE DESERTO



| | | | |
|-----------|----------------|---------|---------------|
| ART. 6117 | Lettere/Numeri | ↓ mm 15 | spessore mm 6 |
| ART. 6122 | Lettere/Numeri | ↓ mm 20 | spessore mm 6 |
| ART. 6127 | Lettere/Numeri | ↓ mm 25 | spessore mm 6 |
| ART. 6132 | Lettere/Numeri | ↓ mm 30 | spessore mm 6 |
| ART. 6142 | Lettere/Numeri | ↓ mm 40 | spessore mm 6 |
| ART. 6152 | Lettere/Numeri | ↓ mm 50 | spessore mm 6 |

| Finitura | | | |
|----------|-------|--------------|-------|
| SHADOW | + 20% | RIFLESSI | + 20% |
| YELLOW | + 20% | PATINA SCURA | + 20% |
| BIANCO | + 10% | ASTER | + 60% |
| ORO | + 60% | OTIPRINT | + 60% |

Le date possono essere richieste:

- A corpo unico distanziate con punto
- Sciolte (aumento 20%)
- Non c'è maiuscola, le lettere hanno tutte la stessa altezza
- Non è possibile richiederlo compresso o allargato

Dates can be ordered:

- A a unique piece divided by a point
- Loose (increase by 20%)
- There is no capital letter, letters have all the same height
- It's not possible request it compressed or expanded



- Le date possono essere: incorporate - appoggiate - sciolte.
- I numeri si intendono su barretta
- Per lettere e numeri singoli aumento del 20%.
- Negli ordini citare sempre l'altezza delle lettere a corpo semplice (a-c-m-r).
- Le lettere maiuscole hanno un'altezza doppia delle lettere minuscole e vengono conteggiate allo stesso prezzo delle lettere minuscole.
- Punteggiatura gratuita fino a mm 40.
- L'altezza delle date indica sempre il numero con asta compresa.
- The numbers can be requested: on underscore - incorporated - single.
- The numbers are to be meant on underscore if not differently specified at the order.
- For single letters and numbers: increase 20%.
- In the orders always indicate the height of the lower-case letters in simple type size (a-c-m, etc...).
- Capital letters are double of small letters; they have the same price.
- Free punctuation up to mm 40
- The height of the dates are always indicated number included underscore.

| | | | |
|-----------|----------------|---------|---------------|
| ART. 6223 | Lettere/Numeri | ↓ mm 20 | spessore mm 6 |
| ART. 6228 | Lettere/Numeri | ↓ mm 25 | spessore mm 6 |
| ART. 6233 | Lettere/Numeri | ↓ mm 30 | spessore mm 6 |
| ART. 6243 | Lettere/Numeri | ↓ mm 40 | spessore mm 6 |

| Finitura | | | |
|----------|-------|--------------|-------|
| SHADOW | + 20% | RIFLESSI | + 20% |
| YELLOW | + 20% | PATINA SCURA | + 20% |
| BIANCO | + 10% | ASTER | + 60% |
| ORO | + 60% | OTIPRINT | + 60% |

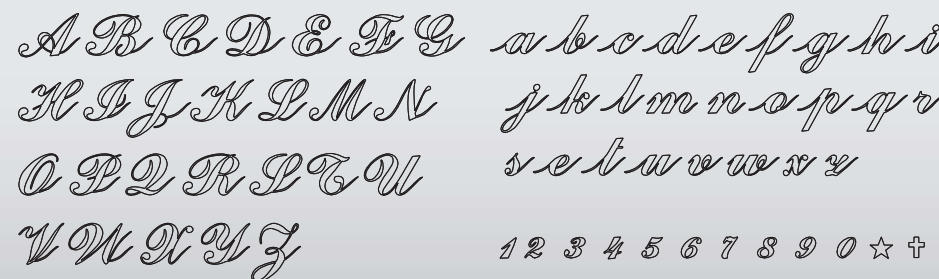

Vezzani
Vezzani
12 10 2006

Il corsivo PLAIN può essere richiesto: SOLO STANDARD

Plain can be ordered: ONLY STANDARD

- Le date possono essere: incorporate - appoggiate - sciolte (con aumento del 20%)

| | | | |
|-----------|----------------|----------|---------------|
| ART. 6116 | Lettere/Numeri | ↓ mm 15 | spessore mm 3 |
| ART. 6121 | Lettere/Numeri | ↓ mm 20 | spessore mm 3 |
| ART. 6126 | Lettere/Numeri | ↓ mm 25 | spessore mm 3 |
| ART. 6131 | Lettere/Numeri | ↓ mm 30 | spessore mm 3 |
| ART. 6141 | Lettere/Numeri | ↓ mm 40 | spessore mm 3 |
| ART. 6151 | Lettere/Numeri | ↓ mm 50 | spessore mm 3 |
| ART. 6161 | Lettere/Numeri | ↓ mm 60 | spessore mm 3 |
| ART. 6181 | Lettere/Numeri | ↓ mm 80 | spessore mm 3 |
| ART. 6195 | Lettere/Numeri | ↓ mm 100 | spessore mm 3 |

Finitura

| | | | |
|--------|-------|--------------|-------|
| SHADOW | + 20% | RIFLESSI | + 20% |
| YELLOW | + 20% | PATINA SCURA | + 20% |
| BIANCO | + 10% | ASTER | + 60% |
| ORO | + 60% | OTIPRINT | + 60% |

A B C D E F G H I a b c d e f g h i j k l m
J K L M N O P Q R n o p q r s t u v w x y
S T U V W X Y 1 2 3 4 5 6 7 8 9 0 + ☆ ▲ Ω

Punteggiatura gratuita fino a mm 50

Lettere e Numeri sciolti: aumento del 20%

- È possibile richiedere il carattere Corsivo Plain di qualsiasi misura, previo preventivo.
- I numeri sono da intendersi su barretta se non diversamente specificato al momento dell'ordine.
- Negli ordini citare sempre l'altezza delle lettere minuscole a corpo semplice (a-c-m-etc...)
- Le lettere maiuscole hanno un'altezza superiore alle lettere minuscole del 40% circa e vengono conteggiate allo stesso prezzo delle lettere minuscole.
- L'altezza delle date indica sempre il numero con asta compresa.

Free punctuation up to 50 mm

Loose letters and numbers: 20% increase

- It is possible to ask for the font Plain italics in any size, after a price estimate
- The numbers are to be meant on underscore if not differently specified at the order
- In the orders always indicate the height of the lower-case letters in simple type size (a-c-m-, etc...)
- The upper-case letters are higher by about 40% than the lower-case letters, and are counted in the same way as the lower-case letters
- The height of the dates are always indicated number included underscore.

ANTARES

| | | | |
|-----------|----------------|----------|-----------------|
| ART. 6115 | Lettere/Numeri | ↓ mm 15 | spessore mm 2,5 |
| ART. 6120 | Lettere/Numeri | ↓ mm 20 | spessore mm 4 |
| ART. 6125 | Lettere/Numeri | ↓ mm 25 | spessore mm 4 |
| ART. 6130 | Lettere/Numeri | ↓ mm 30 | spessore mm 4 |
| ART. 6140 | Lettere/Numeri | ↓ mm 40 | spessore mm 4 |
| ART. 6150 | Lettere/Numeri | ↓ mm 50 | spessore mm 4 |
| ART. 6160 | Lettere/Numeri | ↓ mm 60 | spessore mm 4 |
| ART. 6180 | Lettere/Numeri | ↓ mm 80 | spessore mm 4 |
| ART. 6191 | Lettere/Numeri | ↓ mm 100 | spessore mm 4 |
| ART. 6192 | Lettere/Numeri | ↓ mm 120 | spessore mm 4 |
| ART. 6193 | Lettere/Numeri | ↓ mm 150 | spessore mm 4 |
| ART. 6194 | Lettere/Numeri | ↓ mm 200 | spessore mm 4 |

Finitura

| | | | |
|--------|-------|--------------|-------|
| SHADOW | + 20% | RIFLESSI | + 20% |
| YELLOW | + 20% | PATINA SCURA | + 20% |
| BIANCO | + 10% | ASTER | + 60% |
| ORO | + 60% | OTIPRINT | + 60% |

Il carattere ANTARES può essere richiesto: SOLO STANDARD

ANTARES can be ordered: ONLY STANDARD

- È possibile richiedere il carattere Antares di qualsiasi misura previo preventivo.
- I numeri si intendono su barretta.
- Per lettere e numeri singoli aumento del 20%.
- It is possible to ask for the font Antares in upon estimate.
- The numbers are to be meant on underscore if not differently specified at the order.
- For single letters and numbers: increase 20%.

A B C D E F G H I J K L M
 N O P Q R S T U V W X Y
 1 2 3 4 5 6 7 8 9 0 + ☆ ▲ Ω

Corsivo Millennium

IL CORSIVO MILLENNIUM PUÒ ESSERE RICHIESTO:

COMPRESSO

Millennium

STANDARD

Millennium

ALLARGATO

Millennium

LE DATE POSSONO ESSERE RICHIESTE:

INCORPORATE NELL'ASTA

m. 10 12 2003

APPOGGIATE NELL'ASTA

m. 10 12 2003

SE AL MOMENTO DELL'ORDINE NON VIENE EFFETTUATA ALCUNA SPECIFICAZIONE, IL CORSIVO VIENE PRODOTTO AUTOMATICAMENTE STANDARD E CON DATE INCORPORATE NELL'ASTA.

ART. 6235 Lettere/Numeri ↓ mm 12 spessore mm 3

ART. 6216 Lettere/Numeri ↓ mm 15 spessore mm 3

ART. 6221 Lettere/Numeri ↓ mm 20 spessore mm 4

ART. 6226 Lettere/Numeri ↓ mm 25 spessore mm 4

ART. 6231 Lettere/Numeri ↓ mm 30 spessore mm 4

ART. 6241 Lettere/Numeri ↓ mm 40 spessore mm 4

ART. 6251 Lettere/Numeri ↓ mm 50 spessore mm 4

ART. 6261 Lettere/Numeri ↓ mm 60 spessore mm 4

ART. 6281 Lettere/Numeri ↓ mm 80 spessore mm 4

ART. 6292 Lettere/Numeri ↓ mm 100 spessore mm 4

Finitura

| | | | |
|--------|-------|--------------|-------|
| SHADOW | + 20% | RIFLESSI | + 20% |
| YELLOW | + 20% | PATINA SCURA | + 20% |
| BIANCO | + 10% | ASTER | + 60% |
| ORO | + 60% | OTIPRINT | + 60% |

A B C D E F G H I a b c d e f g h i
 J K L M N O P j k l m n o p q r
 Q R S T U V W s e t u v w x z
 X Y Z 1 2 3 4 5 6 7 8 9 0 † ☆ ▲ Ω

Punteggiatura gratuita fino al mm 50

Doratura: aumento del 60%

Lettere e Numeri sciolti: aumento del 20%

- È possibile richiedere il carattere Corsivo Millennium di qualsiasi misura, previo preventivo.
- I numeri sono da intendersi su barretta se non diversamente specificato al momento dell'ordine.
- Negli ordini citare sempre l'altezza delle lettere minuscole a corpo semplice (a-c-m-etc...).
- Le lettere maiuscole hanno un'altezza superiore alle lettere minuscole del 140% circa e vengono conteggiate allo stesso prezzo delle lettere minuscole.
- L'altezza delle date indica sempre il numero con asta compresa.
- Per ART. 6235 non si possono richiedere numeri sciolti e le date sono solo incorporate.

Free punctuation up to 50 mm

Gilding: 60% increase

Loose letters and numbers: 20% increase

- It is possible to ask for the font Millennium italics in any size, after a price estimate.
- The numbers are to be meant on underscore if not differently specified at the order.
- In the orders always indicate the height of the lower-case letters in simple type size (a-c-m-, etc...).
- The upper-case letters are higher by about 140% than the lower-case letters, and are counted in the same way as the lower-case letters.
- The height of the dates are always indicated number included underscore.
- For ART. 6235 loose numbers cannot be required and date are only incorporated.

NOVITÀ

Millennium
Corsivo

| | | | |
|-------------|----------------|----------|---------------|
| ART. 6235MO | Lettere/Numeri | ↓ mm 12 | spessore mm 3 |
| ART. 6216MO | Lettere/Numeri | ↓ mm 15 | spessore mm 3 |
| ART. 6221MO | Lettere/Numeri | ↓ mm 20 | spessore mm 4 |
| ART. 6226MO | Lettere/Numeri | ↓ mm 25 | spessore mm 4 |
| ART. 6231MO | Lettere/Numeri | ↓ mm 30 | spessore mm 4 |
| ART. 6241MO | Lettere/Numeri | ↓ mm 40 | spessore mm 4 |
| ART. 6251MO | Lettere/Numeri | ↓ mm 50 | spessore mm 4 |
| ART. 6261MO | Lettere/Numeri | ↓ mm 60 | spessore mm 4 |
| ART. 6281MO | Lettere/Numeri | ↓ mm 80 | spessore mm 4 |
| ART. 6292MO | Lettere/Numeri | ↓ mm 100 | spessore mm 4 |

NOVITÀ

Millennium
Corsivo

| | | | |
|-------------|----------------|----------|---------------|
| ART. 6235DU | Lettere/Numeri | ↓ mm 12 | spessore mm 3 |
| ART. 6216DU | Lettere/Numeri | ↓ mm 15 | spessore mm 3 |
| ART. 6221DU | Lettere/Numeri | ↓ mm 20 | spessore mm 4 |
| ART. 6226DU | Lettere/Numeri | ↓ mm 25 | spessore mm 4 |
| ART. 6231DU | Lettere/Numeri | ↓ mm 30 | spessore mm 4 |
| ART. 6241DU | Lettere/Numeri | ↓ mm 40 | spessore mm 4 |
| ART. 6251DU | Lettere/Numeri | ↓ mm 50 | spessore mm 4 |
| ART. 6261DU | Lettere/Numeri | ↓ mm 60 | spessore mm 4 |
| ART. 6281DU | Lettere/Numeri | ↓ mm 80 | spessore mm 4 |
| ART. 6292DU | Lettere/Numeri | ↓ mm 100 | spessore mm 4 |

A B C D E F G H I a b c d e f g h i
 J K L M N O P j k l m n o p q r
 Q R S T U V W s e t u v w x z
 X Y Z 1 2 3 4 5 6 7 8 9 0 † ☆ ▲ Ω

Punteggiatura gratuita fino al mm 50

Doratura: aumento del 60%

Lettere e Numeri sciolti: aumento del 20%

- È possibile richiedere il carattere Corsivo Millennium di qualsiasi misura, previo preventivo.
- I numeri sono da intendersi su barretta se non diversamente specificato al momento dell'ordine.
- Negli ordini citare sempre l'altezza delle lettere minuscole a corpo semplice (a-c-m-etc...).
- Le lettere maiuscole hanno un'altezza superiore alle lettere minuscole del 140% circa e vengono conteggiate allo stesso prezzo delle lettere minuscole.
- L'altezza delle date indica sempre il numero con asta compresa.
- Per ART. 6235DU e 6235MO non si possono richiedere numeri sciolti e le date sono solo incorporate.

Free punctuation up to 50 mm

Gilding: 60% increase

Loose letters and numbers: 20% increase

- It is possible to ask for the font Millennium italics in any size, after a price estimate.
- The numbers are to be meant on underscore if not differently specified at the order.
- In the orders always indicate the height of the lower-case letters in simple type size (a-c-m-, etc...).
- The upper-case letters are higher by about 140% than the lower-case letters, and are counted in the same way as the lower-case letters.
- The height of the dates are always indicated number included underscore.
- For ART. 6235DU and 6235MO loose numbers cannot be required and date are only incorporated

Corsivo Millennium

A B C D E F G H a b c d e f g h i
I J K L M N O P j k l m n o p q r
Q R S T U V W s e t u v w x z
X Y Z 1 2 3 4 5 6 7 8 9 0 † ☆ ▲ Ω

FINITURA BOTTICINO

| | | | |
|-------------|----------------|----------|---------------|
| ART. 6235BO | Lettere/Numeri | ↓ mm 12 | spessore mm 3 |
| ART. 6216BO | Lettere/Numeri | ↓ mm 15 | spessore mm 3 |
| ART. 6221BO | Lettere/Numeri | ↓ mm 20 | spessore mm 4 |
| ART. 6226BO | Lettere/Numeri | ↓ mm 25 | spessore mm 4 |
| ART. 6231BO | Lettere/Numeri | ↓ mm 30 | spessore mm 4 |
| ART. 6241BO | Lettere/Numeri | ↓ mm 40 | spessore mm 4 |
| ART. 6251BO | Lettere/Numeri | ↓ mm 50 | spessore mm 4 |
| ART. 6261BO | Lettere/Numeri | ↓ mm 60 | spessore mm 4 |
| ART. 6281BO | Lettere/Numeri | ↓ mm 80 | spessore mm 4 |
| ART. 6292BO | Lettere/Numeri | ↓ mm 100 | spessore mm 4 |

FINITURA CARRARA

| | | | |
|-------------|----------------|----------|---------------|
| ART. 6235CA | Lettere/Numeri | ↓ mm 12 | spessore mm 3 |
| ART. 6216CA | Lettere/Numeri | ↓ mm 15 | spessore mm 3 |
| ART. 6221CA | Lettere/Numeri | ↓ mm 20 | spessore mm 4 |
| ART. 6226CA | Lettere/Numeri | ↓ mm 25 | spessore mm 4 |
| ART. 6231CA | Lettere/Numeri | ↓ mm 30 | spessore mm 4 |
| ART. 6241CA | Lettere/Numeri | ↓ mm 40 | spessore mm 4 |
| ART. 6251CA | Lettere/Numeri | ↓ mm 50 | spessore mm 4 |
| ART. 6261CA | Lettere/Numeri | ↓ mm 60 | spessore mm 4 |
| ART. 6281CA | Lettere/Numeri | ↓ mm 80 | spessore mm 4 |
| ART. 6292CA | Lettere/Numeri | ↓ mm 100 | spessore mm 4 |

IL CORSIVO MILLENNIUM PUO' ESSERE RICHIESTO:

Millennium COMPRESSO

Millennium STANDARD

Millennium ALLARGATO

LE DATE POSSONO ESSERE RICHIESTE:

INCORPORATE NELL'ASTA
m. 10 12 2003

APPOGGIATE NELL'ASTA
m. 10 12 2003

SE AL MOMENTO DELL'ORDINE NON VIENE EFFETTUATA ALCUNA SPECIFICAZIONE, IL CORSIVO VIENE PRODOTTO AUTOMATICAMENTE STANDARD E CON DATE INCORPORATE NELL'ASTA.

Punteggiatura gratuita fino al mm 50
 Lettere e Numeri sciolti: aumento del 20%

- È possibile richiedere il carattere Corsivo Millennium di qualsiasi misura, previo preventivo.
- I numeri sono da intendersi su barretta se non diversamente specificato al momento dell'ordine.
- Negli ordini citare sempre l'altezza delle lettere minuscole a corpo semplice (a-c-m-etc...).
- Le lettere maiuscole hanno un'altezza superiore alle lettere minuscole del 140% circa e vengono conteggiate allo stesso prezzo delle lettere minuscole.
- L'altezza delle date indica sempre il numero con asta compresa.
- Per ART. 6235BO e 6235CA non si possono richiedere numeri sciolti e le date sono solo incorporate.

Free punctuation up to 50 mm
 Loose letters and numbers: 20% increase

- It is possible to ask for the font Millennium italics in any size, after a price estimate
- The numbers are to be meant on underscore if not differently specified at the order
- In the orders always indicate the height of the lower-case letters in simple type size (a-c-m-, etc...).
- The upper-case letters are higher by about 140% than the lower-case letters, and are counted in the same way as the lower-case letters.
- The height of the dates are always indicated number included underscore.
- For ART. 6235BO and 6235CA loose numbers cannot be required and date are only incorporated

Carattere Digivi

A B C D E F G a b c d e f g h i
 H I J K L M j k l m n o p q r
 X O P Q R S T s e t u u u x z
 U V W X Y Z 1 2 3 4 5 6 7 8 9 0 † ☆

ART. 6217 Lettere/Numeri ↓ mm 15 spessore mm 3

ART. 6222 Lettere/Numeri ↓ mm 20 spessore mm 3

ART. 6227 Lettere/Numeri ↓ mm 25 spessore mm 3

ART. 6232 Lettere/Numeri ↓ mm 30 spessore mm 3

ART. 6242 Lettere/Numeri ↓ mm 40 spessore mm 3

ART. 6252 Lettere/Numeri ↓ mm 50 spessore mm 3

ART. 6262 Lettere/Numeri ↓ mm 60 spessore mm 3

ART. 6282 Lettere/Numeri ↓ mm 80 spessore mm 3

ART. 6293 Lettere/Numeri ↓ mm 100 spessore mm 3

| Finitura | |
|--------------|--------------------|
| SHADOW + 20% | RIFLESSI + 20% |
| YELLOW + 20% | PATINA SCURA + 20% |
| BIANCO + 10% | ASTER + 60% |
| ORO + 60% | OTIPRINT + 60% |

Punteggiatura gratuita fino al mm 50
 Lettere e Numeri sciolti: aumento del 20%

- È possibile richiedere il carattere Corsivo Digivi di qualsiasi misura, previo preventivo.
- Le date possono essere: incorporate - appoggiate - sciolte.
- I numeri sono da intendersi su barretta se non diversamente specificato al momento dell'ordine.
- Negli ordini citare sempre l'altezza delle lettere minuscole a corpo semplice (a-c-m-etc...)
- Le lettere maiuscole hanno un'altezza superiore alle lettere minuscole del 100% circa e vengono conteggiate allo stesso prezzo delle lettere minuscole.
- L'altezza delle date indica sempre il numero con asta compresa.

IL CORSIVO DIGIVI PUÒ ESSERE RICHIESTO:



Free punctuation up to 50 mm
 Loose letters and numbers: 20% increase

- It is possible to ask for the font Digivi italics in any size, after a price estimate
- The numbers can be requested: on underscore - incorporated - single.
- The numbers are to be meant on underscore if not differently specified at the order
- In the orders always indicate the height of the lower-case letters in simple type size (a-c-m-, etc...)
- The upper-case letters are higher by about 140% than the lower-case letters, and are counted in the same way as the lower-case letters.
- The height of the dates are always indicated number included underscore.

Corsivo Smart

- Le date possono essere: incorporate - appoggiate - sciolte.
- Date con numeri sciolti = aumento del 20%
- Punteggiatura gratuita fino al mm 50
- Negli ordini citare sempre l'altezza delle lettere minuscole a corpo semplice (a-c-m...).
- Le lettere maiuscole hanno un'altezza superiore del 100% circa e vengono conteggiate come le minuscole
- L'altezza delle date indica sempre il numero con asta compresa.

- The numbers can be requested: on underscore - incorporated - single.
- Free punctuation up to 50 mm.
- Dates with loose numbers: 20% increase
- In the orders always indicate the height of the lower-case letters in simple type size /a-c-m-, etc...)
- The upper case letters are higher by about 100% than the lower-case letters, and are counted in the same way as the lower case letters.
- The height of the dates are always indicated number included underscore.

ART. 6415 Lettere/Numeri ↓ mm 15 spessore mm 2,5

ART. 6420 Lettere/Numeri ↓ mm 20 spessore mm 2,5

ART. 6425 Lettere/Numeri ↓ mm 25 spessore mm 2,5

ART. 6430 Lettere/Numeri ↓ mm 30 spessore mm 2,5

ART. 6440 Lettere/Numeri ↓ mm 40 spessore mm 2,5

ART. 6450 Lettere/Numeri ↓ mm 50 spessore mm 2,5

ART. 6460 Lettere/Numeri ↓ mm 60 spessore mm 2,5

ART. 6480 Lettere/Numeri ↓ mm 80 spessore mm 2,5

ART. 6491 Lettere/Numeri ↓ mm 100 spessore mm 2,5

| Finitura | |
|--------------|--------------------|
| SHADOW + 20% | RIFLESSI + 20% |
| YELLOW + 20% | PATINA SCURA + 20% |
| BIANCO + 10% | ASTER + 60% |
| ORO + 60% | OTIPRINT + 60% |

A B C D E F G a b c d e f g h i
 H I J K L M N j k l m n o p q r
 O P Q R S T U s e t u v u u x x
 U V W X Y Z 1 2 3 4 5 6 7 8 9 0 ☆ † Ω Δ



ROL
ROSSO LUCIDO
ROO
ROSSO OPACO



VEL
VERDE LUCIDO
VEO
VERDE OPACO



BLL
BLU LUCIDO
BLO
BLU OPACO



AZL
AZZURRO LUCIDO
AZO
AZZURRO OPACO



VIL
VIOLA LUCIDO
VIO
VIOLA OPACO



TOL
TORTORA LUCIDO
TOO
TORTORA OPACO



BEL
BEIGE LUCIDO
BEO
BEIGE OPACO



BIL
BIANCO LUCIDO
BIO
BIANCO OPACO



STL
SATÈN LUCIDO
STO
SATÈN OPACO

| | |
|--------------------------|----------|
| ART. 6111 Lettere/Numeri | ↓ mm 15 |
| ART. 6112 Lettere/Numeri | ↓ mm 20 |
| ART. 6113 Lettere/Numeri | ↓ mm 25 |
| ART. 6114 Lettere/Numeri | ↓ mm 30 |
| ART. 6145 Lettere/Numeri | ↓ mm 40 |
| ART. 6155 Lettere/Numeri | ↓ mm 50 |
| ART. 6165 Lettere/Numeri | ↓ mm 60 |
| ART. 6185 Lettere/Numeri | ↓ mm 80 |
| ART. 6198 Lettere/Numeri | ↓ mm 100 |

Spessore mm 4

Le date possono essere richieste

- A corpo unico distanziate con punto
- Sciolte (aumento 20%)
- Non c'è maiuscola, le lettere hanno tutte la stessa altezza
- Non è possibile richiederlo compresso o allargato.

Dates can be ordered:

- As a unique piece divided by a point
- Loose (increase by 20%)
- There is no capital letter, letters have all the same height
- It's not possible request it compressed or expanded.



ROL
ROSSO LUCIDO



VEL
VERDE LUCIDO



BLL
BLU LUCIDO



AZL
AZZURRO LUCIDO



VIL
VIOLA LUCIDO



TOL
TORTORA LUCIDO



BEL
BEIGE LUCIDO



BIL
BIANCO LUCIDO



STL
SATÈN LUCIDO



ROO
ROSSO OPACO



VEO
VERDE OPACO



BLO
BLU OPACO



AZO
AZZURRO OPACO



VIO
VIOLA OPACO



TOO
TORTORA OPACO



BEO
BEIGE OPACO



BIO
BIANCO OPACO



STO
SATÈN OPACO

| | |
|---------------------------------------|--------------------|
| ART. 6526 Lettere/Numeri/Stella/Croce | ↓ mm 25 |
| ART. 6531 Lettere/Numeri/Stella/Croce | ↓ mm 30 |
| ART. 6541 Lettere/Numeri | ↓ mm 40 |
| ART. 6551 Lettere/Numeri/Stella/Croce | ↓ mm 50 |
| ART. 6596 Trattino | per mm 25-30-40-50 |
| ART. 6597 Virgola | per mm 25-30-40-50 |
| ART. 6598 Accento | per mm 25-30-40-50 |
| ART. 6599 Punto | per mm 25-30-40-50 |

Si possono richiedere pergamene personalizzate con colorazioni "Riflessi"

Per ordinazioni aggiungere al codice articolo la sigla corrispondente alla colorazione scelta.
To place orders add to the article code the letter corresponding the selected colouring.

Per ordinazioni aggiungere al codice articolo la sigla corrispondente alla colorazione scelta.
To place orders add to the article code the letter corresponding the selected colouring.



Grazie all'esperienza, le competenze e la passione nella lavorazione della porcellana, è nato **ETERNITY**, un progetto sviluppato per creare un corsivo unico e inalterabile nel tempo.

Uno strumento a disposizione della clientela, versatile, completamente personalizzabile, facile da utilizzare, ma soprattutto eterno.

Eternità

Sistema produttivo che lo rende insolubile e inalterabile agli agenti atmosferici e qualsiasi intemperie. Eternity è un prodotto che permane nel tempo garantendo un aspetto sempre integro e attuale.

Praticità

Grazie alla sua particolare composizione in un unico elemento, potrà essere applicato in modo semplice e pratico, facilitando al massimo le operazioni di fissaggio.

Personalizzazione

Potrà essere personalizzato, oltreché con dati e generalità uniche richieste dal cliente, anche con tutte le marmorizzazioni disponibili a catalogo. Sarà quindi possibile ottenere soluzioni uniche che esalteranno al meglio il design del prodotto.



Eternity

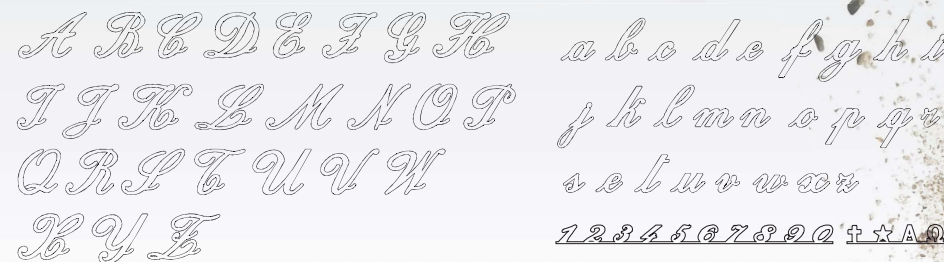

AZZURRO
 ART. 5958AZL ↓ mm 20 spessore mm 7
 ART. 5959AZL ↓ mm 25 spessore mm 7
 ART. 5962AZL ↓ mm 30 spessore mm 7
 ART. 5963AZL ↓ mm 40 spessore mm 7

BIANCO
 ART. 5958BIL ↓ mm 20 spessore mm 7
 ART. 5959BIL ↓ mm 25 spessore mm 7
 ART. 5962BIL ↓ mm 30 spessore mm 7
 ART. 5963BIL ↓ mm 40 spessore mm 7

BLU
 ART. 5958BLL ↓ mm 20 spessore mm 7
 ART. 5959BLL ↓ mm 25 spessore mm 7
 ART. 5962BLL ↓ mm 30 spessore mm 7
 ART. 5963BLL ↓ mm 40 spessore mm 7

VERDE
 ART. 5958VEL ↓ mm 20 spessore mm 7
 ART. 5959VEL ↓ mm 25 spessore mm 7
 ART. 5962VEL ↓ mm 30 spessore mm 7
 ART. 5963VEL ↓ mm 40 spessore mm 7

BEIGE
 ART. 5958BEL ↓ mm 20 spessore mm 7
 ART. 5959BEL ↓ mm 25 spessore mm 7
 ART. 5962BEL ↓ mm 30 spessore mm 7
 ART. 5963BEL ↓ mm 40 spessore mm 7

TORTORA
 ART. 5958TOL ↓ mm 20 spessore mm 7
 ART. 5959TOL ↓ mm 25 spessore mm 7
 ART. 5962TOL ↓ mm 30 spessore mm 7
 ART. 5963TOL ↓ mm 40 spessore mm 7

ROSSO
 ART. 5958ROL ↓ mm 20 spessore mm 7
 ART. 5959ROL ↓ mm 25 spessore mm 7
 ART. 5962ROL ↓ mm 30 spessore mm 7
 ART. 5963ROL ↓ mm 40 spessore mm 7

VIOLA
 ART. 5958VIL ↓ mm 20 spessore mm 7
 ART. 5959VIL ↓ mm 25 spessore mm 7
 ART. 5962VIL ↓ mm 30 spessore mm 7
 ART. 5963VIL ↓ mm 40 spessore mm 7

SATÈNE
 ART. 5958STL ↓ mm 20 spessore mm 7
 ART. 5959STL ↓ mm 25 spessore mm 7
 ART. 5962STL ↓ mm 30 spessore mm 7
 ART. 5963STL ↓ mm 40 spessore mm 7

- È possibile richiedere il carattere Eternity solo nelle misure sopra riportate.
- Non sono disponibili lettere e numeri sciolti.
- Le date sono da intendersi su barretta/appoggiate.
- Negli ordini citare sempre l'altezza delle lettere minuscole a corpo semplice (a-c-m-etc...)
- Le lettere maiuscole hanno un'altezza superiore alle lettere minuscole del 140% circa e vengono conteggiate allo stesso prezzo delle lettere minuscole.
- L'altezza delle date è da intendersi asta compresa.
- Non è possibile richiederlo compresso o allargato.

- It is possible to ask for the font Eternity only in these size.
- Non available loose letters and numbers.
- Dates are to be meant only on underscore.
- In the orders always indicate the height of the lower-case letters in simple type size (a-c-m-, etc...)
- The upper-case letters are higher by about 140% than the lower-case letters, and are counted in the same way as the lower-case letters.
- The height of the dates are always indicated number included underscore.
- It's not possible request it compressed or expanded.



ART. 90340
 † 31,5 ↔ 31,5 ✕ 14 cm
 Display in plexiglass
 8 scritte corsivi bronzo



ART. 90341
 † 31,5 ↔ 31,5 ✕ 14 cm
 Display in plexiglass
 7 scritte corsivi inox



ART. 90339
 † 31,5 ↔ 31,5 ✕ 14 cm
 Display in plexiglass neutro
 personalizzabile



ART. 90313
 † 42 ↔ 29,7 cm



ART. 90312
 † 42 ↔ 29,7 cm
 Display in cartone neutro
 personalizzabile



| | | |
|------------|-----------------------------|---------|
| ART. 6270 | Lettere/Numeri/Stella/Croce | ↓ mm 48 |
| ART. 6271 | Lettere/Numeri/Stella/Croce | ↓ mm 28 |
| ART. 6274 | Punto | ↓ mm 28 |
| ART. 6274- | Trattino | ↓ mm 28 |
| ART. 6274, | Virgola | ↓ mm 28 |
| ART. 6274' | Accento | ↓ mm 28 |



MAIUSCOLA

MINUSCOLA
CENTRALE

MINUSCOLA
TERMINALE

Aaaa Bbbb Cccc Pppp Qqqq Rrrr

Dddd Eeee Ffff Llll Tttt Uuuu

Gggg Hhhh Kkkk Vvvv Wwww Xxxx

Tttt Jjjj Llll Yyyy Zzzz

Mmm Nnn Ooo

PER COMPOSIZIONI EPIGRAFI AUMENTO DEL 20%

| | | |
|------------|--------------------------------------|---------|
| ART. 6000 | Lettere Maiuscole | ↓ mm 60 |
| ART. 6001 | Minuscole centrali | ↓ mm 30 |
| ART. 6002 | Minuscole terminali | ↓ mm 30 |
| ART. 10500 | Barra guida per composizione corsivo | |
| ART. 90606 | Confezione cianacrilato gr. 20 | |

1 2 3 4 5 6 7 8 9 0

n m ✱ † - . ,

1 2 3 4 5 6 7 8 9 0

n m ✱ † ,



ſ a

✱ 28. 10. 1693

18 5 3440

1997 n 2385

m 25. 4. 3548

PER COMPOSIZIONI EPIGRAFI AUMENTO DEL 20%

ART. 6003 Num./Stella/Croce /n/m sciolti ↓ 30 mm

ART. 6004 Num./Stella/Croce /n/m per barretta ↓ 30 mm

ART. 6020 Gambetta iniziale per lettera minuscola

ART. 6021 Punto/Trattino/Virgola/Accento per composizioni sciolte

PER COMPOSIZIONI EPIGRAFI AUMENTO DEL 20%

ART. 6022 Punto per composizioni su barrette

ART. 6023 Barretta cm 11

ART. 6024 Barretta cm 18

ART. 6025 Barretta cm 24

ART. 6026 Barretta cm 31

ISTRUZIONI di MONTAGGIO LETTERE SU BARRETTA



1. Allineare sulla guida la composizione spaziando le lettere di circa 1 cm, quindi mettere una goccia di Loctite su ogni lettera.



2. Serrare lettera per lettera premendo energicamente per qualche secondo.



3. A fine composizione provvedere ad un ultimo serraggio di sicurezza premendo l'intera scritta.



4. Dopo aver atteso il tempo necessario per l'indurimento, pochi secondi (vedi istruzioni Loctite), pulire la scritta dalle eccedenze di colla, facendo scorrere velocemente la scritta sulla carta.

5. Riporre infine la scritta sulla guida ed attendere qualche minuto prima di posizionarla in opera. Per un montaggio ottimale si consiglia di applicare almeno un perno nella prima e ultima lettera.



MATERIALE NECESSARIO PER LA COMPOSIZIONE:
BARRA GUIDA
CIANACRILATO
CARTA ASSORBENTE TIPO SCOTTEX



ART. 10500
Barra guida

ISTRUZIONI di MONTAGGIO NUMERI SU BARRETTA



1



2



3



4



5



6



7



ART. 90606
Confezione cianacrilato 20 gr



| | | |
|-----------|---|---------|
| ART. 6071 | Lettere Maiuscole | ↓ mm 60 |
| ART. 6072 | Lettere Minuscole | ↓ mm 30 |
| ART. 6075 | Numeri/n/m Stella/Croce | ↓ mm 30 |
| ART. 6073 | Punto/Trattino/Virgola/Accento | |
| ART. 6074 | Gambetta iniziale per lettera minuscola | |

A B C D E

F G H K I

J L M N O

P Q R S T

U V W X Y

Z

1 2 3 4 5 6 7

8 9 0 ★ ✝ - · ;

PER COMPOSIZIONI EPIGRAFI AUMENTO DEL 20%

| | | |
|-----------|-----------------------------|----------|
| ART. 6320 | Lettere/Numeri/Stella/Croce | ↓ mm 20 |
| ART. 6325 | Lettere/Numeri/Stella/Croce | ↓ mm 25 |
| ART. 6330 | Lettere/Numeri/Stella/Croce | ↓ mm 30 |
| ART. 6340 | Lettere/Numeri/Stella/Croce | ↓ mm 40 |
| ART. 6350 | Lettere/Numeri | ↓ mm 50 |
| ART. 6360 | Lettere | ↓ mm 60 |
| ART. 6380 | Lettere/Numeri | ↓ mm 80 |
| ART. 6312 | Lettere/Numeri | ↓ mm 120 |

PER COMPOSIZIONI EPIGRAFI AUMENTO DEL 20%

| | | |
|-----------|----------|--------------------------|
| ART. 6396 | Trattino | per mm 25-30-40-50-60-80 |
| ART. 6397 | Virgola | per mm 25-30-40-50-60-80 |
| ART. 6398 | Accento | per mm 25-30-40-50-60-80 |
| ART. 6399 | Punto | per mm 25-30-40-50-60-80 |

A B C D E F

| | | |
|-----------|-----------------------------|---------|
| ART. 6321 | Lettere/Numeri/Stella/Croce | ↓ mm 20 |
| ART. 6326 | Lettere/Numeri/Stella/Croce | ↓ mm 25 |
| ART. 6331 | Lettere/Numeri/Stella/Croce | ↓ mm 30 |
| ART. 6341 | Lettere/Numeri/Stella/Croce | ↓ mm 40 |
| ART. 6351 | Lettere/Numeri | ↓ mm 50 |
| ART. 6361 | Lettere | ↓ mm 60 |
| ART. 6381 | Lettere/Numeri | ↓ mm 80 |

| | | |
|-----------|----------|--------------------|
| ART. 6391 | Trattino | per mm 25-30-40-50 |
| ART. 6393 | Virgola | per mm 25-30-40-50 |
| ART. 6394 | Accento | per mm 25-30-40-50 |
| ART. 6395 | Punto | per mm 25-30-40-50 |

L Q S 2 9 4 5 7

| | | |
|-------------|-----------------------------|---------|
| ART. 6320MO | Lettere/Numeri/Stella/Croce | ↓ mm 20 |
| ART. 6325MO | Lettere/Numeri/Stella/Croce | ↓ mm 25 |
| ART. 6330MO | Lettere/Numeri/Stella/Croce | ↓ mm 30 |
| ART. 6340MO | Lettere/Numeri/Stella/Croce | ↓ mm 40 |
| ART. 6350MO | Lettere/Numeri | ↓ mm 50 |
| ART. 6360MO | Lettere | ↓ mm 60 |

| | | |
|-------------|----------|--------------------------|
| ART. 6396MO | Trattino | per mm 25-30-40-50-60-80 |
| ART. 6397MO | Virgola | per mm 25-30-40-50-60-80 |
| ART. 6398MO | Accento | per mm 25-30-40-50-60-80 |
| ART. 6399MO | Punto | per mm 25-30-40-50-60-80 |

NOVITÀ

CARATTERE **ROMANO OTIPRINT**

A B C

BIANCO

| | | |
|-------------|----------------|---------|
| ART. 6320BI | Lettere/Numeri | ↓ mm 20 |
| ART. 6325BI | Lettere/Numeri | ↓ mm 25 |
| ART. 6330BI | Lettere/Numeri | ↓ mm 30 |
| ART. 6340BI | Lettere/Numeri | ↓ mm 40 |
| ART. 6350BI | Lettere/Numeri | ↓ mm 50 |
| ART. 6360BI | Lettere | ↓ mm 60 |
| ART. 6396BI | Trattino | ↓ mm 20 |
| ART. 6397BI | Virgola | ↓ mm 20 |
| ART. 6398BI | Accento | ↓ mm 20 |
| ART. 6399BI | Punto | ↓ mm 20 |

A B C

CARRARA

| | | |
|-------------|----------------|---------|
| ART. 6320CA | Lettere/Numeri | ↓ mm 20 |
| ART. 6325CA | Lettere/Numeri | ↓ mm 25 |
| ART. 6330CA | Lettere/Numeri | ↓ mm 30 |
| ART. 6340CA | Lettere/Numeri | ↓ mm 40 |
| ART. 6350CA | Lettere/Numeri | ↓ mm 50 |
| ART. 6360CA | Lettere | ↓ mm 60 |
| ART. 6396CA | Trattino | ↓ mm 20 |
| ART. 6397CA | Virgola | ↓ mm 20 |
| ART. 6398CA | Accento | ↓ mm 20 |
| ART. 6399CA | Punto | ↓ mm 20 |

A B C

BOTTICINO

| | | |
|-------------|----------------|---------|
| ART. 6320BO | Lettere/Numeri | ↓ mm 20 |
| ART. 6325BO | Lettere/Numeri | ↓ mm 25 |
| ART. 6330BO | Lettere/Numeri | ↓ mm 30 |
| ART. 6340BO | Lettere/Numeri | ↓ mm 40 |
| ART. 6350BO | Lettere/Numeri | ↓ mm 50 |
| ART. 6360BO | Lettere | ↓ mm 60 |
| ART. 6396BO | Trattino | ↓ mm 20 |
| ART. 6397BO | Virgola | ↓ mm 20 |
| ART. 6398BO | Accento | ↓ mm 20 |
| ART. 6399BO | Punto | ↓ mm 20 |

PER COMPOSIZIONI EPIGRAFI AUMENTO DEL 20%

CARATTERE **ROMANO DUST**

L Q S 2 9 4 5 7

| | | |
|-------------|-----------------------------|---------|
| ART. 6320DU | Lettere/Numeri/Stella/Croce | ↓ mm 20 |
| ART. 6325DU | Lettere/Numeri/Stella/Croce | ↓ mm 25 |
| ART. 6330DU | Lettere/Numeri/Stella/Croce | ↓ mm 30 |
| ART. 6340DU | Lettere/Numeri/Stella/Croce | ↓ mm 40 |
| ART. 6350DU | Lettere/Numeri | ↓ mm 50 |
| ART. 6360DU | Lettere | ↓ mm 60 |

| | | |
|-------------|----------|--------------------------|
| ART. 6396DU | Trattino | per mm 25-30-40-50-60-80 |
| ART. 6397DU | Virgola | per mm 25-30-40-50-60-80 |
| ART. 6398DU | Accento | per mm 25-30-40-50-60-80 |
| ART. 6399DU | Punto | per mm 25-30-40-50-60-80 |

NOVITÀ

CARATTERE **ROMANO ECONOMY**

A B C

| | | |
|-----------|-----------------------------|---------|
| ART. 6328 | Lettere/Numeri/Stella/Croce | ↓ mm 20 |
| ART. 6329 | Lettere/Numeri/Stella/Croce | ↓ mm 25 |
| ART. 6338 | Lettere/Numeri/Stella/Croce | ↓ mm 30 |
| ART. 6348 | Lettere/Numeri/Stella/Croce | ↓ mm 40 |
| ART. 6358 | Lettere/Numeri | ↓ mm 50 |

| | | |
|-----------|----------|--------------------|
| ART. 6386 | Trattino | per mm 25-30-40-50 |
| ART. 6387 | Virgola | per mm 25-30-40-50 |
| ART. 6388 | Accento | per mm 25-30-40-50 |
| ART. 6389 | Punto | per mm 25-30-40-50 |

A B C D E

J L M N O

U V W X Y

1 2 3 4 5 6 7

F G H K I

P Q R S T

Z

8 9 0 ★ ✝ - · ;

La superficie di adesione deve essere perfettamente piana e levigata (marmo, granito, vetro, cristallo, ecc.). Questo fissaggio rende possibili rapide realizzazioni con la sicurezza di un adesivo resistente a temperatura da -30°C a +100°C

PER COMPOSIZIONI EPIGRAFI AUMENTO DEL 20%

| | | |
|-----------|-----------------------------|--------------------|
| ART. 6327 | Lettere/Numeri/Stella/Croce | ↓ mm 25 |
| ART. 6332 | Lettere/Numeri/Stella/Croce | ↓ mm 30 |
| ART. 6342 | Lettere/Numeri | ↓ mm 40 |
| ART. 6352 | Lettere/Numeri | ↓ mm 50 |
| ART. 6376 | Trattino | per mm 25-30-40-50 |
| ART. 6377 | Virgola | per mm 25-30-40-50 |
| ART. 6378 | Accento | per mm 25-30-40-50 |
| ART. 6379 | Punto | per mm 25-30-40-50 |



1. Tracciare a matita la linea di posizionamento del carattere, oppure usare un righello.
2. Tracciare a matita la linea di posizionamento del carattere, oppure usare un righello.
3. Togliere la protezione in carta dell'adesivo, avendo cura di non toccarlo con le mani.
4. Posizionare la lettera allineandola al segno a matita. L'applicazione deve essere eseguita a temperatura ambiente.
5. Premere con forza per qualche secondo.



| | | |
|-----------|---|---------|
| ART. 6325 | Lettere/Numeri/Stella/Croce | ↓ mm 25 |
| ART. 6330 | Lettere speciali/ Lettere/Numeri/Stella/Croce | ↓ mm 30 |
| ART. 6340 | Lettere/Numeri | ↓ mm 40 |
| ART. 6350 | Lettere speciali/ Lettere/Numeri/Stella/Croce | ↓ mm 50 |
| ART. 6396 | Trattino | |
| ART. 6397 | Virgola | |
| ART. 6398 | Accento | |
| ART. 6399 | Punto | |



PER ORDINAZIONI CITARE IL NUMERO CORRISPONDENTE ALLA LETTERA SCELTA

| | | |
|-----------|---|---------|
| ART. 6325 | Lettere speciali/ Lettere/Numeri/Stella/Croce | ↓ mm 25 |
| ART. 6330 | Lettere speciali/ Lettere/Numeri/Stella/Croce | ↓ mm 30 |
| ART. 6340 | Lettere speciali/ Lettere/Numeri/Stella/Croce | ↓ mm 40 |
| ART. 6350 | Lettere speciali/ Lettere/Numeri/Stella/Croce | ↓ mm 50 |
| ART. 6396 | Trattino | |
| ART. 6397 | Virgola | |
| ART. 6398 | Accento | |
| ART. 6399 | Punto | |



PER ORDINAZIONI CITARE IL NUMERO CORRISPONDENTE ALLA LETTERA SCELTA

| | | |
|-----------|---|---------|
| ART. 6325 | Lettere/Numeri/Stella/Croce | ↓ mm 25 |
| ART. 6330 | Lettere speciali/ Lettere/Numeri/Stella/Croce | ↓ mm 30 |
| ART. 6340 | Lettere/Numeri | ↓ mm 40 |
| ART. 6350 | Lettere speciali/ Lettere/Numeri/Stella/Croce | ↓ mm 50 |
| ART. 6396 | Trattino | |
| ART. 6397 | Virgola | |
| ART. 6398 | Accento | |
| ART. 6399 | Punto | |

CARATTERE **STAMPATELLO**
SALDATO SU BARRETTA

NOVITÀ



| | | |
|-----------|-----------------------------|---------|
| ART. 6054 | Lettere/Numeri/Stella/Croce | ↓ mm 25 |
| ART. 6055 | Lettere/Numeri/Stella/Croce | ↓ mm 30 |
| ART. 6056 | Lettere/Numeri/Stella/Croce | ↓ mm 40 |
| ART. 6057 | Lettere/Numeri/Stella/Croce | ↓ mm 50 |

A B C D E F
 G H I J K L
 M N O P Q R
 S T U V W
 X Y Z

a b c d e
 f g h i
 l m n o p
 q r s t u
 v w x y z

1 2 3 4 5 6 7 8 9 0

* † — • • •

mb

| | |
|---|-------------------------------------|
| MAIUSCOLO | |
| PER COMPOSIZIONI EPIGRAFI AUMENTO DEL 20% | |
| ART. 6650 | Lettere ↓ mm 50 |
| MINUSCOLO | |
| PER COMPOSIZIONI EPIGRAFI AUMENTO DEL 20% | |
| ART. 6625 | Lettere/Numeri/Stella/Croce ↓ mm 25 |
| ART. 6635 | Lettere/Numeri/Stella/Croce ↓ mm 35 |
| ART. 6692 | Trattino per mm 25 |
| ART. 6693 | Virgola per mm 25 |
| ART. 6694 | Accento per mm 25 |
| ART. 6695 | Punto per mm 25 |
| ART. 6696 | Trattino per mm 35 |
| ART. 6697 | Virgola per mm 35 |
| ART. 6698 | Accento per mm 35 |
| ART. 6699 | Punto per mm 35 |



PER COMPOSIZIONI EPIGRAFICHE AUMENTO DEL 20%

| | | |
|-----------|-----------------------------|-----------------|
| ART. 6825 | Lettere/Numeri/Stella/Croce | ↓ mm 25 |
| ART. 6830 | Lettere/Numeri/Stella/Croce | ↓ mm 30 |
| ART. 6840 | Lettere/Numeri | ↓ mm 40 |
| ART. 6850 | Lettere | ↓ mm 50 |
| ART. 6896 | Trattino | per mm 25-30-40 |
| ART. 6897 | Virgola | per mm 25-30-40 |
| ART. 6898 | Accento | per mm 25-30-40 |
| ART. 6899 | Punto | per mm 25-30-40 |
| ART. 6886 | Trattino | per mm 50 |
| ART. 6887 | Virgola | per mm 50 |
| ART. 6888 | Accento | per mm 50 |
| ART. 6889 | Punto | per mm 50 |



A B C D E

F G H K I

J L M N O

P Q R S T

U V W X Y

Z

1 2 3 4 5 6 7

8 9 0 ★ † — … ’

PER COMPOSIZIONI EPIGRAFI AUMENTO DEL 20%

ART. 6526 Lettere/Numeri/Stella/Croce ↓ mm 25

ART. 6531 Lettere/Numeri/Stella/Croce ↓ mm 30

ART. 6541 Lettere/Numeri ↓ mm 40

ART. 6551 Lettere ↓ mm 50

ART. 6561 Lettere ↓ mm 60

ART. 6581 Lettere ↓ mm 80

ART. 6512 Lettere/Numeri/Stella/Croce ↓ mm 120

ART. 6596 Trattino per mm 25-30-40-50-60

ART. 6597 Virgola per mm 25-30-40-50-60

ART. 6598 Accento per mm 25-30-40-50-60

ART. 6599 Punto per mm 25-30-40-50-60

ART. 6591 Punto per mm 80

ART. 6592 Trattino per mm 120

ART. 6086 Accento per mm 50-60

ART. 6593 Virgola per mm 120

ART. 6594 Accento per mm 120

ART. 6595 Punto per mm 120



A B C D E F G H
 I J L M N O P Q R S
 T U V W X Y Z
 1 2 3 4 5 6 7 8 9 0 ★ ✝ - , ;

| | | |
|------------|-----------------------------|--------------------|
| ART. D6325 | Lettere/Numeri/Stella/Croce | ↓ mm 25 |
| ART. D6330 | Lettere/Numeri/Stella/Croce | ↓ mm 30 |
| ART. D6340 | Lettere/Numeri | ↓ mm 40 |
| ART. D6350 | Lettere/Numeri | ↓ mm 50 |
| ART. D6360 | Lettere | ↓ mm 60 |
| ART. D6380 | Lettere/Numeri | ↓ mm 80 |
| ART. D6396 | Trattino | ↓ mm 20 |
| ART. D6397 | Virgola | ↓ mm 25 |
| ART. D6398 | Accento | ↓ mm 30 |
| ART. D6399 | Punto | per mm 25-30-40-50 |

CONCORD DORATO

A b c

| | | |
|-----------|---|---------|
| ART. 6010 | Lettere | ↓ mm 60 |
| ART. 6011 | Minuscole centrali | ↓ mm 30 |
| ART. 6012 | Minuscole terminali | ↓ mm 30 |
| ART. 6013 | Numero/Stella/Croce/n/m sciolti | |
| ART. 6014 | Numero/Stella/Croce/n/m per barretta | |
| ART. 6040 | Gambetta iniziale per lettere minuscole | |
| ART. 6041 | Punteggiatura per composizioni sciolte | |
| ART. 6042 | Punto per composizioni su barretta | |
| ART. 6043 | Barretta | cm 11 |
| ART. 6044 | Barretta | cm 18 |
| ART. 6045 | Barretta | cm 24 |
| ART. 6046 | Barretta | cm 31 |

A B C D E F G
 H K I J L M N
 O P Q R S T U
 V W X Y Z
 1 2 3 4 5 6 7
 8 9 0 ★ † - , ;

| | | |
|-----------|-----------------------------|--------------------|
| ART. 5826 | Lettere/Numeri/Stella/Croce | ↓ mm 25 |
| ART. 5831 | Lettere/Numeri/Stella/Croce | ↓ mm 30 |
| ART. 5841 | Lettere | ↓ mm 40 |
| ART. 5851 | Lettere | ↓ mm 50 |
| ART. 5893 | Trattino | per mm 25-30-40-50 |
| ART. 5894 | Virgola | per mm 25-30-40-50 |
| ART. 5895 | Punto | per mm 25-30-40-50 |



PAX
ART. 6087
↓ cm 5
ART. 6088
↓ cm 6
ART. 6089
↓ cm 8



ART. 6519
DELTA ↓ cm 4
ART. 6518
DELTA ↓ cm 6



INTERNATIONAL
ART. 6813 ↓ cm 3

INTERNATIONAL
ART. 6815 ↓ cm 5



ART. 6314
ROMANO ↓ cm 4

ART. 6316
ROMANO ↓ cm 6



FEDI
ART. 6432
↓ cm 2,5



DELTA ART. 6517
↓ cm 2,5
DELTA ART. 6513
↓ cm 3
DELTA ART. 6514
↓ cm 4
DELTA ART. 6515
↓ cm 5
DELTA ART. 6516
↓ cm 6



INTERNATIONAL
ART. 6819
↓ cm 5
ART. 6818
↓ cm 4
ART. 6817
↓ cm 3
ART. 6816
↓ cm 2,5



CON PERNO
ART. 6333
↓ cm 2,5
ART. 6334
↓ cm 3
ART. 6335
↓ cm 4
ART. 6336
↓ cm 5
ART. 6337
↓ cm 6



ADESIVA
ART. 6343
↓ cm 2,5
ART. 6344
↓ cm 3
ART. 6345
↓ cm 4
ART. 6346
↓ cm 5
ART. 6337
↓ cm 6



CON PERNO
ART. 6421
↓ cm 2,5
ART. 6422
↓ cm 3
ART. 6423
↓ cm 4
ART. 6424
↓ cm 5
ART. 6431
↓ cm 6

ADESIVA
ART. 6426
↓ cm 2,5
ART. 6427
↓ cm 3
ART. 6428
↓ cm 4
ART. 6429
↓ cm 5



ART. 31424 con adesivo



ART. 31423 con adesivo



ART. 31422 con adesivo



ART. 31421 con adesivo



CONCORD
ART. 6027 ↓ cm 6

CONCORD
ART. 6005 ↓ cm 6

CONCORD CENTRALE
ART. 6006 ↓ cm 3

CONCORD CENTRALE
ART. 6028 ↓ cm 3

CONCORD TERMINALE
ART. 6029 ↓ cm 3



PIPA SLAVA
ROMANO
ART. 6392



ART. 6520
PIPA SLAVA DELTA
ART. 6353
↓ cm 2,5
ART. 6354
↓ cm 4



ART. 6375



ART. 6373



ART. 6374



ART. 6521
TRATTINO DELTA

INTERS POUR CROIX



ART. 31450



ART. 31451



ART. 31454 con adesivo
ART. 31456 no adesivo



ART. 31455 con adesivo
ART. 31457 no adesivo



LIBRI E PERGAMENE



PISTOLA
ART. 90872

CARTUCCIA
ART. 90823

MISCELATORE STATICO
+ UGELLO
ART. 90870



SILICONE
ART. 90604 310 ml.



ACCESSORI VEZZANI SYSTEM

PISTOLA CARTUCCIA MISCELATORE STATICO UGELLO



Comporre la pistola alzando la levetta sulla destra ed inserendo il pezzo di completamento.



Inserire la doppia cartuccia nell'apposita pistola.



Bloccare la cartuccia, abbassando l'apposita chiusura.



Togliere il tappo e il feltrino all'estremità della cartuccia e conservarli.



Inserire il miscelatore statico ad incastro nella cartuccia.



Fare uscire la prima parte del composto e non usarla in modo da avere la sicurezza che quello che si utilizzerà sia giustamente miscelato.



Inserire l'ugello al miscelatore statico.



Introdurre l'ugello nel foro del marmo o granito ed erogare. Alla fine dell'erogazione rilasciare il grilletto ed alzare velocemente e con decisione la pistola per evitare che il componente faccia il filo.



A completamento del lavoro si toglie il miscelatore statico e il relativo ugello e si buttano. Poi si chiude la cartuccia con il feltrino e il tappo originario.

CARATTERISTICHE TECNICHE

- Resina epossidica bicomponente (50% resina - 50% catalizzatore/induritore)
- 20 minuti tempo di indurimento (indicativo secondo la temperatura)
- Scadenza: 1 anno
- Con una cartuccia si fanno in media 10 lapidi

VANTAGGI

- Notevole vantaggio di tempo nella applicazione
- Non bisogna fare pulizia dopo la posa delle lettere
- Nessuno spreco di materiale

ACCORGIMENTI UTILI

- Tenere a portata di mano uno straccetto per pulizia ugello
- Non esporre al sole perchè diventa più liquido
- Se tenuto in frigo fa meno filo



CORSIVO



STAMPATELLO



ROMANO



BASTONE

PERSONALIZZABILI - incisione inclusa nel prezzo



NOVITÀ

- ART. 38820 ↓ 7 ↔ 10 cm
- ART. 38821 ↓ 7,5 ↔ 15 cm
- ART. 38823 ↓ 10 ↔ 20 cm
- ART. 38824 ↓ 15 ↔ 30 cm
- ART. 38826 ↓ 20 ↔ 40 cm

incisione inclusa nel prezzo



PERGAMENA PERSONALIZZABILE CON INCISIONE

- ART. 38713 ↓ 7,5 ↔ 10 cm
- ART. 38736 ↓ 11,5 ↔ 15,5 cm
- ART. 38714 ↓ 15 ↔ 20 cm

SENZA INCISIONE

- ART. 38713L ↓ 7,5 ↔ 10 cm
- ART. 38736L ↓ 11,5 ↔ 15,5 cm
- ART. 38714L ↓ 15 ↔ 20 cm

FINITURA DUST



- ART. 38713DU ↓ 7,5 ↔ 10 cm
- ART. 38736DU ↓ 11,5 ↔ 15,5 cm
- ART. 38714DU ↓ 15 ↔ 20 cm



- ART. 38716DU ↓ 5 ↔ 10 cm
- ART. 38717DU ↓ 7,5 ↔ 15 cm
- ART. 38718DU ↓ 10 ↔ 20 cm
- ART. 38789DU ↓ 15 ↔ 30 cm
- ART. 38790DU ↓ 20 ↔ 40 cm



- ART. 38721DU ↓ 5 ↔ 10 cm
- ART. 38722DU ↓ 7,5 ↔ 15 cm
- ART. 38723DU ↓ 10 ↔ 20 cm
- ART. 38774DU ↓ 15 ↔ 30 cm
- ART. 38775DU ↓ 20 ↔ 40 cm

NOVITÀ



- ART. 38801 ↓ 7,5 ↔ 10 cm
- ART. 38737 ↓ 11,5 ↔ 15,5 cm
- ART. 38810 ↓ 15 ↔ 20 cm



- ART. 38802 ↓ 7,5 ↔ 10 cm
- ART. 38738 ↓ 11,5 ↔ 15,5 cm
- ART. 38811 ↓ 15 ↔ 20 cm



- ART. 38803 ↓ 7,5 ↔ 10 cm
- ART. 38739 ↓ 11,5 ↔ 15,5 cm
- ART. 38812 ↓ 15 ↔ 20 cm



- ART. 38804 ↓ 7,5 ↔ 10 cm
- ART. 38741 ↓ 11,5 ↔ 15,5 cm
- ART. 38813 ↓ 15 ↔ 20 cm



- ART. 38805 ↓ 7,5 ↔ 10 cm
- ART. 38742 ↓ 11,5 ↔ 15,5 cm
- ART. 38814 ↓ 15 ↔ 20 cm



- ART. 38806 ↓ 7,5 ↔ 10 cm
- ART. 38743 ↓ 11,5 ↔ 15,5 cm
- ART. 38815 ↓ 15 ↔ 20 cm

PIASTRE PER INCISIONE TAGLIATE DA LASTRA

PERSONALIZZABILI - incisione inclusa nel prezzo

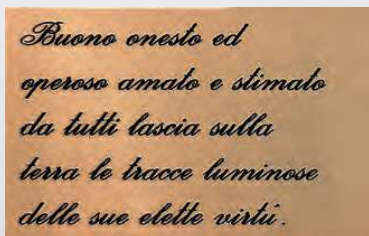

- ART. 30007 ↓ 5 ↔ 10 cm
- ART. 30008 ↓ 10 ↔ 15 cm
- ART. 30009 ↓ 15 ↔ 20 cm



- ART. 38807 ↓ 7,5 ↔ 10 cm
- ART. 38746 ↓ 11,5 ↔ 15,5 cm
- ART. 38816 ↓ 15 ↔ 20 cm



- ART. 38808 ↓ 7,5 ↔ 10 cm
- ART. 38744 ↓ 11,5 ↔ 15,5 cm
- ART. 38817 ↓ 15 ↔ 20 cm

BOTTICINO

CARRARA



ART. 38716 ↓5 ↔ 10 cm
ART. 38717 ↓7,5 ↔ 15 cm
ART. 38718 ↓10 ↔ 20 cm
ART. 38789 ↓15 ↔ 30 cm
ART. 38790 ↓20 ↔ 40 cm

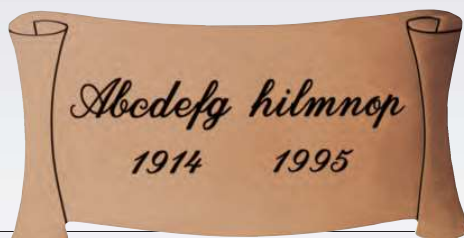

ART. 38721 ↓5 ↔ 10 cm
ART. 38722 ↓7,5 ↔ 15 cm
ART. 38723 ↓10 ↔ 20 cm
ART. 38774 ↓15 ↔ 30 cm
ART. 38775 ↓20 ↔ 40 cm



ART. 38713BO ↓7,5 ↔ 10 cm
ART. 38736BO ↓11,5 ↔ 15,5 cm
ART. 38714BO ↓15 ↔ 20 cm



ART. 38713CA ↓7,5 ↔ 10 cm
ART. 38736CA ↓11,5 ↔ 15,5 cm
ART. 38714CA ↓15 ↔ 20 cm



ART. 38734 ↓6 ↔ 10 cm
ART. 38724 ↓9,5 ↔ 17 cm
ART. 38729 ↓12,5 ↔ 22,5 cm

NOVITÀ



ART. 38726 ↓10 ↔ 10 cm
ART. 38727 ↓14,5 ↔ 15 cm
ART. 38728 ↓19,5 ↔ 20 cm
ART. 38711 ↓29 ↔ 30 cm



ART. 38721BO ↓5 ↔ 10 cm
ART. 38722BO ↓7,5 ↔ 15 cm
ART. 38723BO ↓10 ↔ 20 cm



ART. 38721CA ↓5 ↔ 10 cm
ART. 38722CA ↓7,5 ↔ 15 cm
ART. 38723CA ↓10 ↔ 20 cm



ART. 38716BO ↓5 ↔ 10 cm
ART. 38717BO ↓7,5 ↔ 15 cm
ART. 38718BO ↓10 ↔ 20 cm



ART. 38716CA ↓5 ↔ 10 cm
ART. 38717CA ↓7,5 ↔ 15 cm
ART. 38718CA ↓10 ↔ 20 cm



ART. 38868 bianco e nero
ART. 38869 colori
TARGA ↓ 17 ↔ 30 cm FOTOCERAMICA 7x9 cm



ART. 38844 ↓ 10 ↔ 20 cm



ART. 38846 ↓ 13,5 ↔ 22,5 cm



ART. 38864 bianco e nero
ART. 38865 colori
TARGA ↓ 9 ↔ 15 cm MINIATURA 3,5x4,5 cm



ART. 38862 bianco e nero
ART. 38863 colori
TARGA ↓ 7 ↔ 11 cm MINIATURA 2,5x3,5 cm



ART. 38841 ↓ 18 ↔ 34 cm



ART. 38866 bianco e nero
ART. 38867 colori
TARGA ↓ 13 ↔ 20 cm FOTOCERAMICA 5x7 cm



ART. 38842 ↓ 20 ↔ 34 cm



ART. 38847 ↓ 10 ↔ 20 cm



ART. 38848 ↓ 15,5 ↔ 31 cm



ART. 38849 ↓ 19 ↔ 16 cm



ART. 38837 ↓ 15 ↔ 26 cm



ART. 38840 ↓ 10 ↔ 20 cm
ART. 38836 ↓ 13 ↔ 23 cm



Targhetta INRI
ART. 31202 ↓ 5,5 ↔ 7,5 cm



Targhetta INRI
ART. 31201 ↓ 5 ↔ 4 cm

TARGHE FUSE

PERSONALIZZABILI



SI POSSONO RICHIEDERE TARGHE FUSE IN BRONZO
DI QUALSIASI DIMENSIONE, FINITURA CLASSICA O CON COLORE FONDO A RICHIESTA.



ART. 38510/40 ↓ 10 ↔ 12 cm - Fino a 40 lettere
 ART. 38510/100 ↓ 10 ↔ 12 cm - Fino a 100 lettere
 ART. 38510/150 ↓ 10 ↔ 12 cm - Fino a 150 lettere

ART. 38511/40 ↓ 15 ↔ 18 cm - Fino a 40 lettere
 ART. 38511/100 ↓ 15 ↔ 18 cm - Fino a 100 lettere
 ART. 38511/150 ↓ 15 ↔ 18 cm - Fino a 150 lettere

ART. 38512/40 ↓ 20 ↔ 24 cm - Fino a 40 lettere
 ART. 38512/100 ↓ 20 ↔ 24 cm - Fino a 100 lettere
 ART. 38512/150 ↓ 20 ↔ 24 cm - Fino a 150 lettere

P



ART. 38513/40 ↓ 25 ↔ 30 cm - Fino a 40 lettere
 ART. 38513/100 ↓ 25 ↔ 30 cm - Fino a 100 lettere
 ART. 38513/150 ↓ 25 ↔ 30 cm - Fino a 150 lettere

ART. 38514/40 ↓ 30 ↔ 36 cm - Fino a 40 lettere
 ART. 38514/100 ↓ 30 ↔ 36 cm - Fino a 100 lettere
 ART. 38514/150 ↓ 30 ↔ 36 cm - Fino a 150 lettere

ART. 38515/40 ↓ 40 ↔ 48 cm - Fino a 40 lettere
 ART. 38515/100 ↓ 40 ↔ 48 cm - Fino a 100 lettere
 ART. 38515/150 ↓ 40 ↔ 48 cm - Fino a 150 lettere

P



ART. 38530/40 ↓ 10 ↔ 12 cm - Fino a 40 lettere
 ART. 38530/100 ↓ 10 ↔ 12 cm - Fino a 100 lettere
 ART. 38530/150 ↓ 10 ↔ 12 cm - Fino a 150 lettere

ART. 38531/40 ↓ 15 ↔ 18 cm - Fino a 40 lettere
 ART. 38531/100 ↓ 15 ↔ 18 cm - Fino a 100 lettere
 ART. 38531/150 ↓ 15 ↔ 18 cm - Fino a 150 lettere

ART. 38532/40 ↓ 20 ↔ 24 cm - Fino a 40 lettere
 ART. 38532/100 ↓ 20 ↔ 24 cm - Fino a 100 lettere
 ART. 38532/150 ↓ 20 ↔ 24 cm - Fino a 150 lettere

T



ART. 38533/40 ↓ 25 ↔ 30 cm - Fino a 40 lettere
 ART. 38533/100 ↓ 25 ↔ 30 cm - Fino a 100 lettere
 ART. 38533/150 ↓ 25 ↔ 30 cm - Fino a 150 lettere

ART. 38534/40 ↓ 30 ↔ 36 cm - Fino a 40 lettere
 ART. 38534/100 ↓ 30 ↔ 36 cm - Fino a 100 lettere
 ART. 38534/150 ↓ 30 ↔ 36 cm - Fino a 150 lettere

ART. 38535/40 ↓ 40 ↔ 48 cm - Fino a 40 lettere
 ART. 38535/100 ↓ 40 ↔ 48 cm - Fino a 100 lettere
 ART. 38535/150 ↓ 40 ↔ 48 cm - Fino a 150 lettere

T



ART. 38544
48x23,5 cm

ART. 38558
48x23,5 cm

ART. 38541
30x18,5 cm

ART. 38563
30x18,5 cm

ART. 38566
↓ 20 cm

ART. 38567
↓ 13 cm



ART. 38545
48x23,5 cm

ART. 38560
48x23,5 cm

ART. 38542
30x18,5 cm

ART. 38565
30x18,5 cm

ART. 38570
↓ 20 cm

ART. 38571
↓ 13 cm



ART. 38543
48x23,5 cm

ART. 38559
48x23,5 cm

ART. 38540
30x18,5 cm

ART. 38564
30x18,5 cm

ART. 38568
↓ 20 cm

ART. 38569
↓ 13 cm



ART. 38551
48x22,5 cm

ART. 38588
48x22,5 cm

ART. 38548
30x18,5 cm

ART. 38574
30x18,5 cm

ART. 38579
↓ 20 cm

ART. 38580
↓ 13 cm



ART. 38550
48x22,5 cm

ART. 38561
48x22,5 cm

ART. 38547
30x18,5 cm

ART. 38572
30x18,5 cm

ART. 38575
↓ 20 cm

ART. 38576
↓ 13 cm



ART. 38549
48x22,5 cm

ART. 38562
48x22,5 cm

ART. 38546
30x18,5 cm

ART. 38573
30x18,5 cm

ART. 38577
↓ 20 cm

ART. 38578
↓ 13 cm



ART. 38556
48x19,5 cm



ART. 38553
30x20,5 cm



ART. 38536
↓ 20 cm



ART. 38537
↓ 13 cm



ART. 38557
48x19,5 cm



ART. 38554
30x20,5 cm



ART. 38647
↓ 20 cm



ART. 38648
↓ 13 cm



ART. 38555
48x19,5 cm



ART. 38552
30x20,5 cm



ART. 38538
↓ 20 cm



ART. 38539
↓ 13 cm



ART. 38663
58x20 cm



ART. 38662
44x19 cm



ART. 38661
36x18 cm



ART. 38660
33x18 cm



ART. 38655
33x18 cm



ART. 38656
36x18 cm



ART. 38657
44x19 cm



ART. 38658
58x20 cm



ART. 38670
50x42 cm



ART. 38653
58x20 cm



ART. 38652
44x19 cm



ART. 38651
36x18 cm



ART. 38650
33x18 cm



Sinistro

Destro

ART. 38649 Diritto
25x16 cm

ART. 38659 Sinistro
25x16 cm

ART. 38659 Destro
25x16 cm

ART. 38654 Diritto
25x16 cm



ART. 38665
50x42 cm



Diritto
ART. 38581 58x20 cm
Sinistro
ART. 38582 58x20 cm
Destro
ART. 38583 58x20 cm



Diritto
ART. 38584 44x19 cm
Sinistro
ART. 38585 44x19 cm
Destro
ART. 38586 44x19 cm



Diritto
ART. 38587 36x18 cm
Sinistro
ART. 38589 36x18 cm
Destro
ART. 38590 36x18 cm



Diritto
ART. 38465 58x20 cm
Sinistro
ART. 38466 58x20 cm
Destro
ART. 38467 58x20 cm



Diritto
ART. 38468 44x19 cm
Sinistro
ART. 38469 44x19 cm
Destro
ART. 38470 44x19 cm



Diritto
ART. 38471 36x18 cm
Sinistro
ART. 38472 36x18 cm
Destro
ART. 38473 36x18 cm



Angolo Sinistro
ART. 38591 50x42 cm
Angolo Destro
ART. 38592 50x42 cm



Diritto
ART. 38593 33x18 cm
Sinistro
ART. 38594 33x18 cm
Destro
ART. 38595 33x18 cm



Diritto
ART. 38462 25x16 cm
Sinistro
ART. 38463 25x16 cm
Destro
ART. 38464 25x16 cm



Angolo Sinistro
ART. 38474 50x42 cm
Angolo Destro
ART. 38475 50x42 cm



Diritto
ART. 38476 33x18 cm
Sinistro
ART. 38477 33x18 cm
Destro
ART. 38478 33x18 cm



Diritto
ART. 38479 25x16 cm
Sinistro
ART. 38492 25x16 cm
Destro
ART. 38493 25x16 cm



Diritto
ART. 38494 58x20 cm
 Sinistro
ART. 38495 58x20 cm
 Destro
ART. 38496 58x20 cm



Diritto
ART. 38497 44x19 cm
 Sinistro
ART. 38498 44x19 cm
 Destro
ART. 38499 44x19 cm



Diritto
ART. 38500 36x18 cm
 Sinistro
ART. 38501 36x18 cm
 Destro
ART. 38502 36x18 cm



Angolo Sinistro
ART. 38503 50x42 cm
 Angolo Destro
ART. 38504 50x42 cm



Diritto
ART. 38505 33x18 cm
 Sinistro
ART. 38506 33x18 cm
 Destro
ART. 38507 33x18 cm



Diritto
ART. 38508 25x16 cm
 Sinistro
ART. 38509 25x16 cm
 Destro
ART. 38520 25x16 cm



ART. 38642
 9x5 cm



ART. 38521
 9x5 cm



ART. 38522
 9x5 cm



ART. 38523
 9x5 cm



ART. 38640
 8x7 cm



ART. 38524
 8x7 cm



ART. 38526
 8x7 cm



ART. 38528
 8x7 cm

ART. 38641
 15x14 cm

ART. 38525
 15x14 cm

ART. 38527
 15x14 cm

ART. 38529
 15x14 cm



ART. 38639
 13x6 cm



ART. 38370
 13x6 cm



ART. 38371
 13x6 cm



ART. 38372
 13x6 cm



ART. 38636
14x9 cm



ART. 38373
14x9 cm



ART. 38375
14x9 cm



ART. 38377
14x9 cm



Crisantemo
ART. 38632
13x7 cm



Crisantemo
ART. 38386
13x7 cm



Crisantemo
ART. 38643
8x5 cm



Crisantemo
ART. 38387
8x5 cm



ART. 38609
14x9 cm



ART. 38379
14x9 cm



ART. 38381
14x9 cm



ART. 38383
14x9 cm



Viola del pensiero
ART. 38644
9x5 cm



Viola del pensiero
ART. 38388
9x5 cm



Viola del pensiero
ART. 38637
13x7 cm
ART. 38634
19x11 cm



Viola del pensiero
ART. 38389
13x7 cm
ART. 38390
19x11 cm

ART. 38603
20x12 cm

ART. 38380
20x12 cm

ART. 38382
20x12 cm

ART. 38384
20x12 cm



Stella alpina
ART. 38633
14x7 cm



Stella alpina
ART. 38385
14x7 cm



Margherita
ART. 38631
16x7 cm



Margherita
ART. 38391
16x7 cm



ART. 38610
29x29 cm



ART. 38608
32x24 cm



ART. 38616
35x35 cm Sinistro



ART. 38613
35x13 cm

ART. 38617
35x35 cm Destro



ART. 38638
28x8 cm



ART. 38611
17x10 cm



ART. 38645
31x18 cm



ART. 38646
31x18 cm



ART. 38620
Ø 2,5 cm

ART. 38602
42x12 cm

ART. 38612
25x13 cm

ART. 38625
Ø 5 cm



* ART. 30832 Ø cm 4
* ART. 30968 Ø cm 5
* ART. 30969 Ø cm 6
A RICHIESTA PERNO M8



* ART. 43620 Ø cm 3
* ART. 43621 Ø cm 4
* ART. 43622 Ø cm 5
* ART. 43623 Ø cm 6
* ART. 43624 Ø cm 8



ART. 30907 Ø cm 3
ART. 30907M8 Ø cm 3
ART. 30941 Ø cm 5,5
ART. 30941M8 Ø cm 5,5

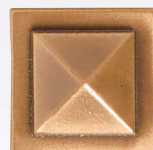

* ART. 30833 cm 3x3
* ART. 30834 cm 4x4
* ART. 30835 cm 5x5
ART. 30835M8 cm 5x5



* ART. 43600 cm 3x3
* ART. 43601 cm 4x4
* ART. 43602 cm 5x5
* ART. 43603 cm 6x6



* ART. 30801 Ø cm 2x2
* ART. 30803 Ø cm 3x3
* ART. 30804 Ø cm 4x4
* ART. 30800 Ø cm 4,5x4,5
* ART. 30805 Ø cm 5x5
* ART. 30849 Ø cm 6x6



* ART. 30830 Ø cm 4
* ART. 30831 Ø cm 5



ART. 30964 Ø cm 5
Predisposta per il perno Ø 5 MA non compreso nel prezzo
ART. 30965 Ø cm 5
Predisposta per il perno Ø 10 MA non compreso nel prezzo
ART. 30966 Ø cm 8
Predisposta per il perno Ø 6 MA non compreso nel prezzo
A RICHIESTA PERNO M8



* ART. 30843 Ø cm 3
* ART. 30844 Ø cm 4
* ART. 30845 Ø cm 5

OTIPRINT



BIANCO
* ART. 30832BI Ø cm 4
* ART. 30968BI Ø cm 5
* ART. 30969BI Ø cm 6
A RICHIESTA PERNO M8



CARRARA
* ART. 30832CA Ø cm 4
* ART. 30968CA Ø cm 5
* ART. 30969CA Ø cm 6
A RICHIESTA PERNO M8



BOTTICINO
* ART. 30832BO Ø cm 4
* ART. 30968BO Ø cm 5
* ART. 30969BO Ø cm 6
A RICHIESTA PERNO M8

* I prezzi delle borchie si intendono senza perni e sono predisposte di serie per il perno di Ø 5 MA - ART. 91150

Regolabile portante



ART. 30921 Ø cm 3
Perno di Ø 8 MA compreso nel prezzo



Borchia Regolabile Portante
ART. 30940 Ø cm 5,5
Perno di Ø 8 MA compreso nel prezzo
ART. 30962 Ø cm 5
Perno di Ø 12 MA compreso nel prezzo



ART. 30948 Ø cm 3
Perno di Ø 8 MA compreso nel prezzo
ART. 30949 Ø cm 5
Perno di Ø 8 MA compreso nel prezzo



ART. 30958 Ø cm 5
Perno di Ø 8 MA compreso nel prezzo

OTIPRINT



BIANCO
ART. 30948BI Ø cm 3
Perno Ø 8 MA compreso nel prezzo
ART. 30949BI Ø cm 5
Perno Ø 8 MA compreso nel prezzo



CARRARA
ART. 30948CA Ø cm 3
Perno Ø 8 MA compreso nel prezzo
ART. 30949CA Ø cm 5
Perno Ø 8 MA compreso nel prezzo



BOTTICINO
ART. 30948BO Ø cm 3
Perno Ø 8 MA compreso nel prezzo
ART. 30949BO Ø cm 5
Perno Ø 8 MA compreso nel prezzo

AVVERTENZE PER L'UTENTE: le staffe o borchie portanti, raffigurate nel presente catalogo, sono realizzate con materiale di alta qualità da consentire il mantenimento nel tempo delle loro caratteristiche. La funzionalità e la sicurezza delle stesse è condizionata alla corretta installazione che prevede l'utilizzo di due staffe o borchie sul lato inferiore e due sul lato superiore di ogni lastra copriloculo.

NOTE FOR THE USER: the support brackets or load bearing studs, shown in this catalogue, have been made with special quality material that maintains its characteristics with the passing of time. The functionality and safety of these items depend upon their correct installation, which provides for the use of two brackets or studs on the lower side and two on the upper side of each loculus cover slab.

Regolabili portanti per marmo da cm 1-2-3
a = spessore marmo

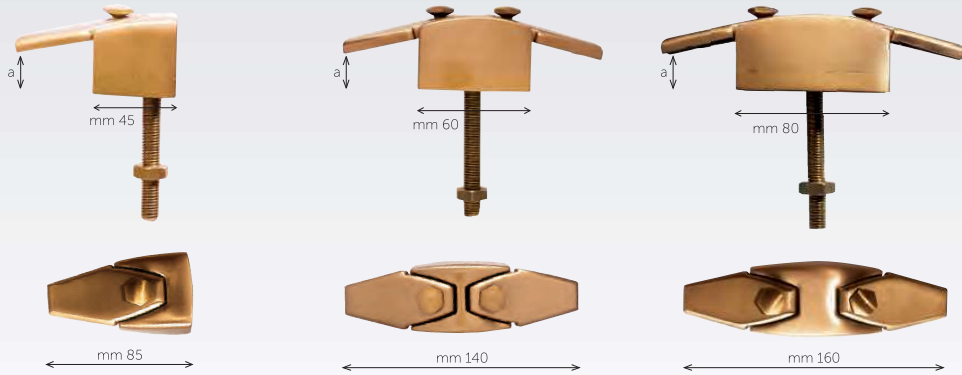

ART. 30770 - a = cm 2-3
Perno da Ø 10 MA x 100 compreso nel prezzo
ART. 30773 - a = cm 2-3
Perno da Ø 8 MA x 100 compreso nel prezzo

ART. 30771 - a = cm 2-3
Perno da Ø 10 MA x 100 compreso nel prezzo
ART. 30774 - a = cm 2-3
Perno da Ø 8 MA x 100 compreso nel prezzo

ART. 30772 - a = cm 2-3
Perno da Ø 10 MA x 100 compreso nel prezzo
ART. 30775 - a = cm 2-3
Perno da Ø 8 MA x 100 compreso nel prezzo

Regolabili portanti per marmo da cm 1-2
a = spessore marmo

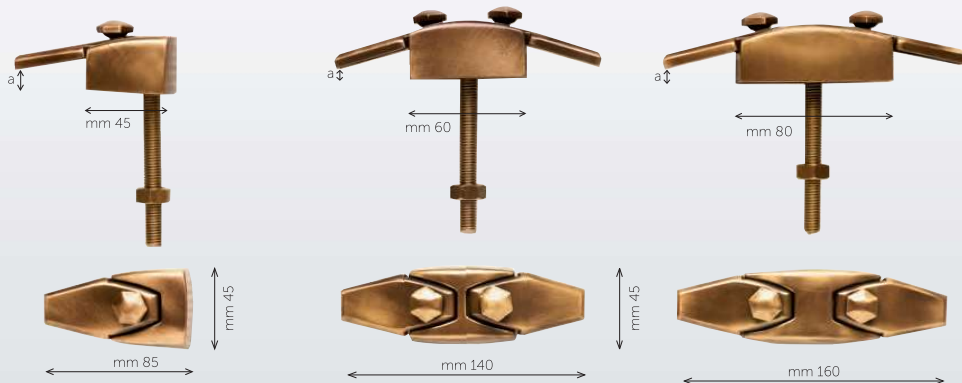

ART. 30930 - a = cm 1-2
Perno da Ø 10 MA x 100 compreso nel prezzo
ART. 30942 - a = cm 1-2
Perno da Ø 8 MA x 100 compreso nel prezzo

ART. 30931 - a = cm 1-2
Perno da Ø 10 MA x 100 compreso nel prezzo
ART. 30943 - a = cm 1-2
Perno da Ø 8 MA x 100 compreso nel prezzo

ART. 30932 - a = cm 1-2
Perno da Ø 10 MA x 100 compreso nel prezzo
ART. 30944 - a = cm 1-2
Perno da Ø 8 MA x 100 compreso nel prezzo

Regolabili portanti per marmo da cm 1-2-3

OTIPRINT

PERNO DA Ø 10 MA COMPRESO NEL PREZZO

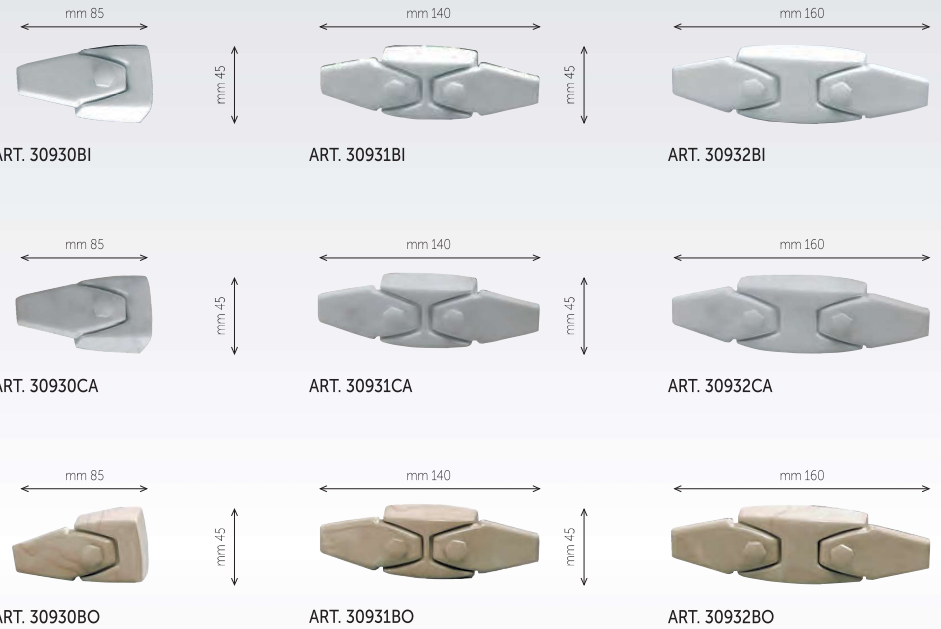

ART. 30930BI

ART. 30931BI

ART. 30932BI

ART. 30930CA

ART. 30931CA

ART. 30932CA

ART. 30930BO

ART. 30931BO

ART. 30932BO

STAFFE PER OSSARIO

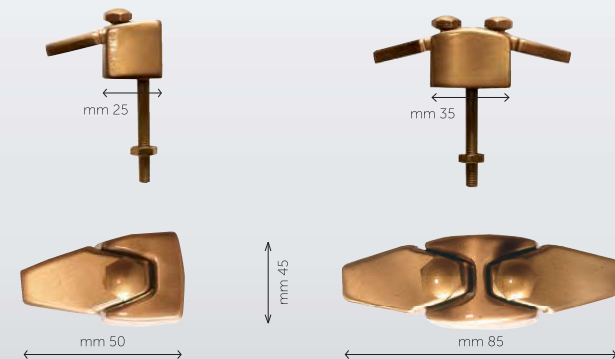

ART. 30977
Perno da Ø 8 MA x 100 compreso nel prezzo

ART. 30978
Perno da Ø 8 MA x 100 compreso nel prezzo

Regolabili portanti per marmo da cm 1-2
a = spessore marmo

CAPPUCCIO BRONZO

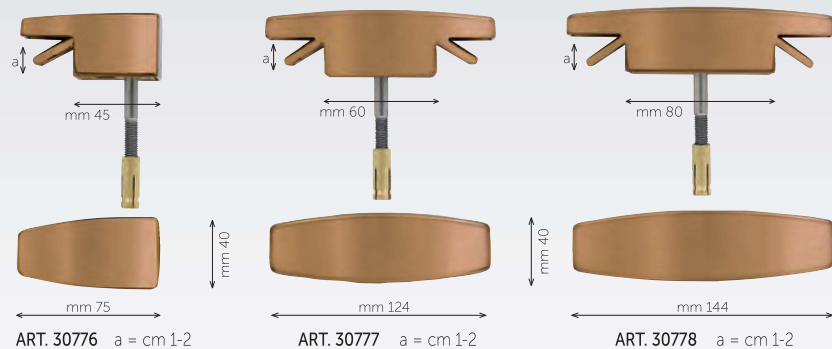

CAPPUCCIO PATINATO BRONZO



CAPPUCCIO PATINATO BRONZO FINITURA CROMATA



VITE INOX CON ESAGONO INCASSO+TASSELLO OTTONE M8 COMPRESI NEL PREZZO

Regolabili portanti per marmo da cm 1-2
a = spessore marmo

CAPPUCCIO PATINATO BOTTICINO



CAPPUCCIO PATINATO BIANCO DI CARRARA

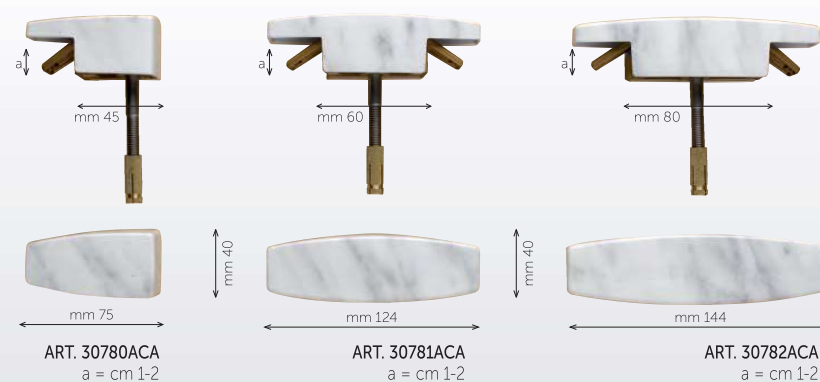

VITE INOX CON ESAGONO INCASSO+TASSELLO OTTONE M8 COMPRESI NEL PREZZO

*Regolabili portanti per marmo da cm 1-2-3
a = spessore marmo*

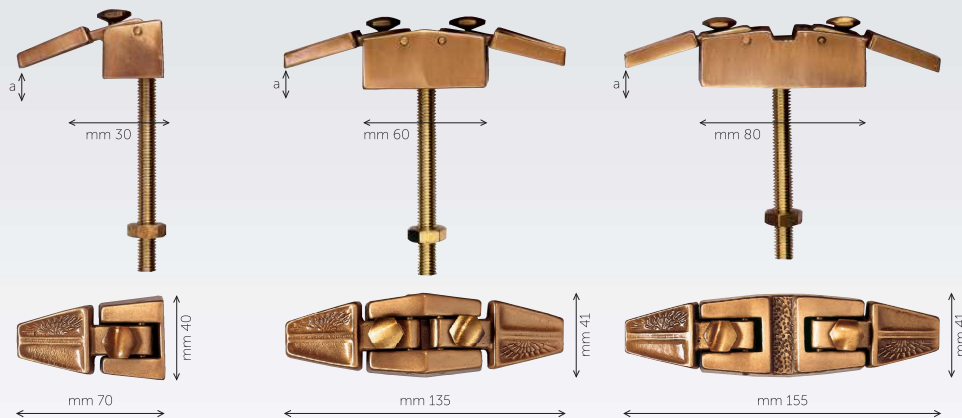

ART. 30970 - a = cm 1-2
ART. 30972 - a = cm 2-3
Perno da Ø 10 MA x 100 compreso nel prezzo

ART. 30971 - a = cm 1-2
ART. 30973 - a = cm 2-3
Perno da Ø 10 MA x 100 compreso nel prezzo

ART. 30975 - a = cm 1-2
ART. 30976 - a = cm 1-3
Perno da Ø 10 MA x 100 compreso nel prezzo

Regolabili non portanti

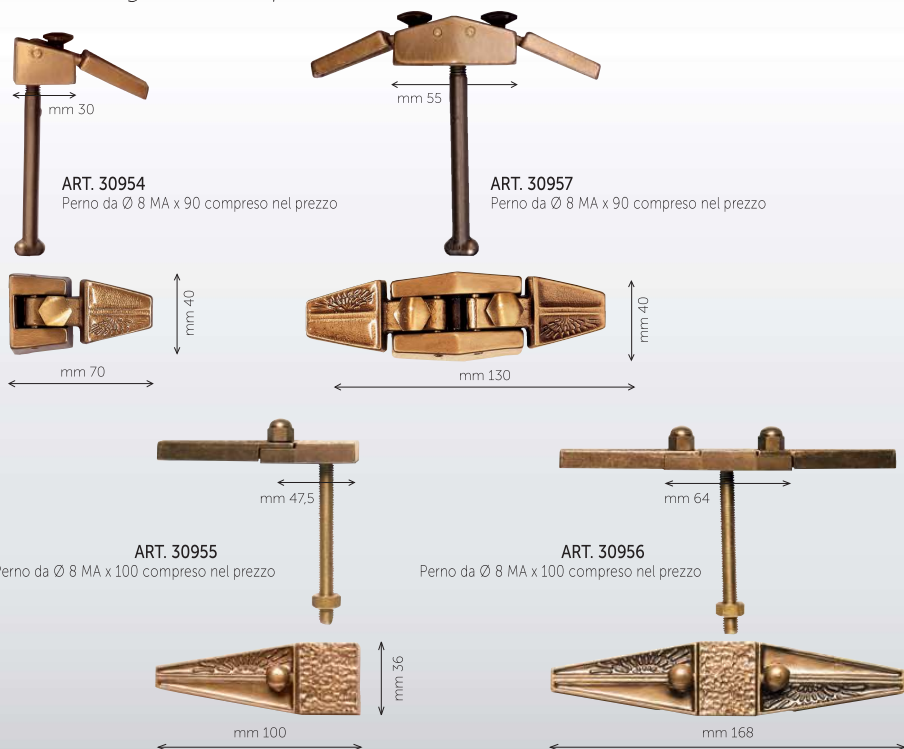

ART. 30954
Perno da Ø 8 MA x 90 compreso nel prezzo

ART. 30957
Perno da Ø 8 MA x 90 compreso nel prezzo

ART. 30955
Perno da Ø 8 MA x 100 compreso nel prezzo

ART. 30956
Perno da Ø 8 MA x 100 compreso nel prezzo

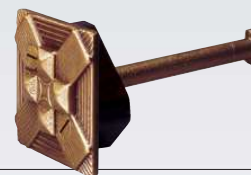

Borchia tipo Ortona
ART. 30840 6x6 cm
Perno Ø 10 MA x 100 compreso nel prezzo



Borchia
ART. 43630 Ø 6x19 cm
Perno Ø 10 MA compreso nel prezzo



Borchia ad innesto
ART. 30847 5x5 cm



Borchia Bottone
ART. 30848 Ø cm 2

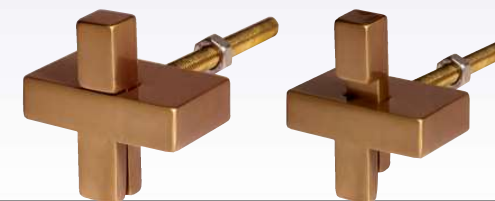

Borchia
ART. 30929 † 6 ↔ 6 cm
Perno Ø 8 MA compreso nel prezzo



ART. 30967 - 8 MA 3x3,5 cm



Chiavarda
ART. 10880
Prezzo della sola chiavarda. Aggiungere il prezzo della borchia desiderata e del perno. Per marmi dello spessore di cm 2-2,5-3-3,5-4-4,5.
Può essere applicata sulle seguenti borchie:
30800 - 30804 - 30813 - 30814 - 30815 - 30816
30823 - 30824 - 30825 - 30826 - 30828 - 30833
30834 - 30843 - 30844 - 30845 - 30854
30863 - 30864 - 30865.
Negli ordinativi citare lo spessore del marmo e il tipo di borchia desiderato.

AVVERTENZE PER L'UTENTE: le staffe o borchie portanti, raffigurate nel presente catalogo, sono realizzate con materiale di alta qualità da consentire il mantenimento nel tempo delle loro caratteristiche. La funzionalità e la sicurezza delle stesse è condizionata alla corretta installazione che prevede l'utilizzo di due staffe o borchie sul lato inferiore e due sul lato superiore di ogni lastra copriloculo.

NOTE FOR THE USER: the support brackets or load bearing studs, shown in this catalogue, have been made with special quality material that maintains its characteristics with the passing of time. The functionality and safety of these items depend upon their correct installation, which provides for the use of two brackets or studs on the lower side and two on the upper side of each loculus cover slab.

NOVITÀ



SU 4 COLONNINE

- ART. 31052 ↓ 11 ↔ 20 ↗ 11 cm
- ART. 31053 ↓ 11 ↔ 25 ↗ 11 cm
- ART. 31054 ↓ 11 ↔ 30 ↗ 11 cm
- ART. 31055 ↓ 11 ↔ 35 ↗ 11 cm

SU 5 COLONNINE

- ART. 31056 ↓ 11 ↔ 40 ↗ 11 cm
- ART. 31057 ↓ 11 ↔ 50 ↗ 11 cm
- ART. 31058 ↓ 11 ↔ 60 ↗ 11 cm
- ART. 31059 ↓ 11 ↔ 70 ↗ 11 cm



SU 2 COLONNINE

- ART. 31070 ↓ 10 ↔ 20 cm
- ART. 31071 ↓ 10 ↔ 25 cm
- ART. 31072 ↓ 10 ↔ 30 cm
- ART. 31073 ↓ 10 ↔ 35 cm

SU 3 COLONNINE

- ART. 31074 ↓ 10 ↔ 40 cm
- ART. 31075 ↓ 10 ↔ 50 cm
- ART. 31076 ↓ 10 ↔ 60 cm
- ART. 31077 ↓ 10 ↔ 70 cm

NOVITÀ



SU 4 COLONNINE

- ART. 11410 ↓ 11 ↔ 20 ↗ 11 cm
- ART. 11411 ↓ 11 ↔ 25 ↗ 11 cm
- ART. 11412 ↓ 11 ↔ 30 ↗ 11 cm
- ART. 11413 ↓ 11 ↔ 35 ↗ 11 cm

SU 5 COLONNINE

- ART. 11414 ↓ 11 ↔ 40 ↗ 11 cm
- ART. 11415 ↓ 11 ↔ 50 ↗ 11 cm
- ART. 11416 ↓ 11 ↔ 60 ↗ 11 cm
- ART. 11417 ↓ 11 ↔ 70 ↗ 11 cm



SU 2 COLONNINE

- ART. 11418 ↓ 10 ↔ 20 cm
- ART. 11419 ↓ 10 ↔ 25 cm
- ART. 11420 ↓ 10 ↔ 30 cm
- ART. 11421 ↓ 10 ↔ 35 cm

SU 3 COLONNINE

- ART. 11422 ↓ 10 ↔ 40 cm
- ART. 11423 ↓ 10 ↔ 50 cm
- ART. 11424 ↓ 10 ↔ 60 cm
- ART. 11425 ↓ 10 ↔ 70 cm



ART. 91570 Ø 5x70
ART. 91580 Ø 6x80
ART. 91590 Ø 8x100
ART. 91599 Ø 10x100



PERNO
ART. 91450 5 MA x50
ART. 91460 5 MA x60
ART. 91470 5 MA x70



INOX
ART. 91155 8 MA x100
ART. 91156 10 MA x100



TASSELLO AD ESPANSIONE
ART. 90157 passo 6 MA
ART. 90155 passo 8 MA
ART. 90156 passo 10 MA



Catena
ART. 31210 Maglia cm 9
Prezzo al metro



Catena
ART. 31215 Maglia cm 9
Prezzo al metro



Catena
ART. 31200 Maglia cm 11
Prezzo al metro

BACCHETTE PER LAMPADE DA APPENDERE



Perno ART. 91340 da TPS mm 40
Perno ART. 91350 da TPS mm 50
Perno ART. 91360 da TPS mm 60
Perno ART. 91370 da TPS mm 70



Perno ART. 91130 3 MA X 35
Perno ART. 91140 4 MA X 50
Perno ART. 91150 5 MA X 50
Perno ART. 91154 6 MA X 60
Perno ART. 91160 5 MA X 60
Perno ART. 91170 5 MA X 70
Perno ART. 91180 5 MA X 80



Patta ART. 30913 cm 8
Patta ART. 30914 cm 10
Patta ART. 30915 cm 12
Predisposte per il perno di Ø 5 MA



Patta ART. 30908 cm 8
Patta ART. 30910 cm 10
Patta ART. 30912 cm 12
Predisposte per il perno di Ø 5 MA



INOX



ART. 10205 † 30
compreso anello



ART. 31205 † 30
compreso anello



Gancio
ART. 38400 Perno Ø 5 MA 4,5x4 cm
ART. 38408 Perno Ø 8 MA 6x5 cm



ART. 38401
Gancio Ø 8 cm



Rosone
ART. 38410
cm 15x12



ART. 30684 Ø cm 7
ART. 30685 Ø cm 8
ART. 30693 Ø cm 10



ART. 30690 Ø cm 8
ART. 30691 Ø cm 10



ART. 30997 cm 5 x 8
sporgenza 12 cm
ART. 30996 cm 5 x 11
sporgenza 15 cm



ART. 38430
Staffa
per portafiori cm 20 e lampada Ø 5



ART. 38435
Staffa
per portafiori cm 28 e lampada Ø 6



ART. 30949



ART. 30931



ART. 30971



ART. 30840





ART. 17671 | P
↑ 19 ↔ 9 cm

ART. 17171 | T
↑ 19 ↔ 9 cm



ART. 19671 R | P
↑ 17 ↔ 14 cm

ART. 19171 R | T
↑ 17 ↔ 14 cm



ART. 16671 Ø 5 | P
↑ 19 ↔ 9 cm

ART. 16271 Ø 5 | T
↑ 19 ↔ 9 cm



ART. 11607
9x12 cm

ART. 11608
11x15 cm



ART. 11621
9x12 cm

SERIE **RAFFAELLO ORO**



ART. 17672 | P
↑ 21 ↔ 14 cm

ART. 17172 | T
↑ 21 ↔ 14 cm



ART. 19672 R | P
↑ 17 ↔ 14 cm

ART. 19172 R | T
↑ 17 ↔ 14 cm



ART. 16672 Ø 5 | P
↑ 19 ↔ 10 cm

ART. 16272 Ø 5 | T
↑ 19 ↔ 10 cm



ART. 14250
↑ 20 ↔ 8 cm

ART. 14251
↑ 30 ↔ 13 cm



ART. 14260
↑ 20 ↔ 8 cm

ART. 14261
↑ 30 ↔ 13 cm

SERIE **REGGIO LISCIA**



ART. 17670 | P
↑ 19 ↔ 9 cm

ART. 17170 | T
↑ 19 ↔ 9 cm



ART. 19670 R | P
↑ 17 ↔ 14 cm

ART. 19170 R | T
↑ 17 ↔ 14 cm



ART. 16670 Ø 5 | P
↑ 19 ↔ 9 cm

ART. 16270 Ø 5 | T
↑ 19 ↔ 9 cm



ART. 11605
9x12 cm

ART. 11606
11x15 cm



ART. 11620
9x12 cm

ACCIAIO INOX



ART. 17022 | T
↓ 28 ↔ 14 cm



ART. 17520 | P
↓ 19 ↔ 10 cm



ART. 17020 | T
↓ 19 ↔ 10 cm



ART. 17021 | T
↓ 20 ↔ 10 cm



ART. 17521 | P
↓ 20 ↔ 10 cm



ART. 16121 Ø 6
↓ 22 ↔ 10 cm



ART. 16260 Ø 5
↓ 18 ↔ 8 cm



ART. 16120 Ø 5
↓ 18 ↔ 8 cm



ART. 16122 Ø 5
↓ 19 ↔ 8 cm



ART. 16261 Ø 5
↓ 19 ↔ 8 cm



ART. 11601
7x9 cm
ART. 11602
8x10 cm
ART. 11603
9x12 cm
ART. 11604
11x15 cm



ART. 11610
7x9 cm
ART. 11611
8x10 cm
ART. 11612
9x12 cm
ART. 11613
10x15 cm
ART. 11614
11x15 cm
ART. 11615
13x18 cm
ART. 11616
18x24 cm



ART. 12408 ↓ 8 ↔ 4 cm
ART. 12410 ↓ 10 ↔ 4 cm
ART. 12412 ↓ 12 ↔ 5 cm
ART. 12415 ↓ 15 ↔ 5 cm
ART. 12420 ↓ 20 ↔ 6 cm
ART. 12425 ↓ 25 ↔ 7 cm
ART. 12430 ↓ 30 ↔ 8 cm
ART. 12435 ↓ 35 ↔ 8 cm
ART. 12440 ↓ 40 ↔ 10 cm



ART. 14015 ↓ 15 ↔ 10 cm
ART. 14020 ↓ 20 ↔ 10 cm
ART. 14025 ↓ 25 ↔ 10 cm
ART. 14030 ↓ 30 ↔ 10 cm
ART. 14035 ↓ 35 ↔ 10 cm
ART. 14040 ↓ 40 ↔ 10 cm



ART. 17800 | P
↓ 22 ↔ 11 cm

ART. 17100 | T
↓ 22 ↔ 11 cm



ART. 17953 | P
↓ 21 ↔ 10 cm

ART. 17153 | T
↓ 21 ↔ 10 cm



ART. 16950 Ø 5 | P
↓ 19 ↔ 11 cm

ART. 16150 Ø 5 | T
↓ 20 ↔ 11 cm



ART. 17952 | P
↓ 20 ↔ 10 cm

ART. 17152 | T
↓ 20 ↔ 10 cm



ART. 16960 Ø 5 | P
↓ 19 ↔ 11 cm

ART. 16160 Ø 5 | T
↓ 20 ↔ 11 cm



ART. 17810 | P
↓ 21 ↔ 11 cm

ART. 17110 | T
↓ 22 ↔ 11 cm



ART. 16952 Ø 5 | P
↓ 18 ↔ 8 cm

ART. 16152 Ø 5 | T
↓ 18 ↔ 8 cm



ART. 19952 R/C | P
↓ 16 ↔ 15 cm

ART. 19152 R/C | T
↓ 16 ↔ 15 cm



ART. 16651 | P
↓ 15 ↔ 11 cm

ART. 16451 | T
↓ 15 ↔ 11 cm



ART. 17710 P
↓ 17 ↔ 12 cm



ART. 16306 P
↓ 13 ↔ 11 cm



ART. 17701 P
↓ 12 ↔ 8 cm



ART. 16301 Ø 4
↓ 15 ↔ 7 cm

ART. 17310 P T
↓ 19 ↔ 12 cm

ART. 16106 T
↓ 14 ↔ 11 cm

ART. 17714 P
↓ 20 ↔ 12 cm

ART. 17314 P
↓ 22 ↔ 12 cm

Fiamma 11x7 cm

ART. 17301 P T
↓ 13 ↔ 8 cm

ART. 16101 Ø 4 T
↓ 17 ↔ 7 cm



ART. 17711 P
↓ 17 ↔ 13 cm



ART. 17724 P
↓ 20 ↔ 12 cm



ART. 16307 P
↓ 13 ↔ 12 cm



ART. 16107 T
↓ 14 ↔ 12 cm

ART. 16312 P
↓ 13 ↔ 11 cm

ART. 16116 T
↓ 13 ↔ 11 cm

ART. 17715 P
↓ 20 ↔ 13 cm

ART. 17333 P T
↓ 22 ↔ 12 cm

Fiamma 11x7 cm

Fiamma 11x7 cm

ART. 17311 P T
↓ 19 ↔ 13 cm

ART. 17315 P
↓ 22 ↔ 13 cm



ART. 11726 9x12 cm
ART. 11727 10x15 cm
ART. 11728 11x15 cm
ART. 11733 13x18 cm



ART. 11704 9x12 cm
ART. 11705 11x15 cm
ART. 11707 13x18 cm



ART. 18104 9x12 cm
ART. 18105 11x15 cm
ART. 18107 13x18 cm



ART. 18126 9x12 cm
ART. 18127 10x15 cm
ART. 18128 11x15 cm
ART. 18133 13x18 cm

ACCIAIO INOX



ART. 17638 P
↓ 20 ↔ 12 cm



ART. 19505 P
↓ 18 ↔ 20 cm



ART. 16241 Ø 5
↓ 17 ↔ 12 cm

ART. 17243 P
↓ 21 ↔ 12 cm

ART. 19104 P
↓ 20 ↔ 20 cm

ART. 16064 Ø 5
↓ 18 ↔ 12 cm

ART. 17248 P
↓ 32 ↔ 18 cm



Plex Nero
ART. 17252 P
↓ 32 ↔ 18 cm



ART. 17249 P
↓ 32 ↔ 18 cm



ART. 17639 P
↓ 20 ↔ 12 cm

ART. 17244 P
↓ 21 ↔ 12 cm



Plex Nero
ART. 17642 P
↓ 20 ↔ 12 cm



Plex Nero
ART. 17247 P
↓ 21 ↔ 12 cm



Plex Nero
ART. 19510 P
↓ 18 ↔ 20 cm

Plex Nero
ART. 19108 P
↓ 20 ↔ 20 cm



ART. 19506 P
↓ 18 ↔ 20 cm

ART. 19105 P
↓ 20 ↔ 20 cm



ART. 16242 Ø 5
↓ 17 ↔ 12 cm

ART. 16065 Ø 5
↓ 18 ↔ 12 cm



ART. 17648 P
↓ 20 ↔ 8 cm

ART. 17253 P
↓ 22 ↔ 8 cm

ART. 17258 P
↓ 28 ↔ 11 cm



ART. 17649 P
↓ 16 ↔ 7 cm

ART. 17257 P
↓ 16 ↔ 7 cm

ART. 17652 P
↓ 13 ↔ 6,5 cm

ART. 17155 P
↓ 13 ↔ 6,5 cm



ART. 16627 Ø 5
↓ 15 ↔ 8 cm

ART. 16078 Ø 5
↓ 18 ↔ 8 cm



ART. 17831 P
↓ 20 ↔ 10 cm



ART. 16931 Ø 5
↓ 19 ↔ 10 cm



ART. 16422 T
↓ 25 ↔ 18 cm



ART. 17440 P
↓ 12 ↔ 5 cm



ART. 17450 P
↓ 10 ↔ 3,5 cm

ART. 17040 P
↓ 12 ↔ 5 cm



ART. 17700 P
↓ 12 ↔ 8 cm

ART. 17708 P
↓ 17 ↔ 12 cm

ART. 17712 P
↓ 20 ↔ 12 cm

ART. 17300 P
↓ 13 ↔ 8 cm

ART. 17308 P
↓ 19 ↔ 12 cm

ART. 17320 P
↓ 30 ↔ 19 cm

ART. 17330 P
↓ 41 ↔ 19 cm



ART. 16300 Ø 4
↓ 15 ↔ 7 cm

ART. 16308 Ø 6
↓ 25 ↔ 11 cm

ART. 16100 Ø 4
↓ 17 ↔ 7 cm

ART. 16108 Ø 6
↓ 27 ↔ 11 cm

ART. 16112 Ø 8
↓ 33 ↔ 18 cm



ART. 16304 P
↓ 13 ↔ 11 cm

ART. 16104 P
↓ 14 ↔ 11 cm

Fiamma 11x7 cm



ART. 17606 P
↓ 17 ↔ 10 cm



ART. 17201 P
↓ 17 ↔ 10 cm



stelo e
copertura
ART. 90910
↓ 35 ↔ 11 cm

portafiori
terreno
ART. 90900
↓ 9 ↔ 18 cm

Negli ordini citare il tipo di cornice desiderata. Il prezzo è composto dal portafiori più stelo e copertura, cornice scelta a parete.



ART. 16740 Ø 4
↓ 12 ↔ 5 cm

ART. 16540 Ø 4
↓ 13 ↔ 5 cm



ART. 16200 Ø 5
↓ 15 ↔ 8 cm

ART. 16010 Ø 5
↓ 18 ↔ 8 cm



ART. 17658 P
↓ 13 ↔ 6,5 cm

ART. 17158 P
↓ 13 ↔ 6,5 cm

ART. 17608 P
↓ 20 ↔ 8 cm

ART. 17206 P
↓ 22 ↔ 8 cm

ART. 17207 P
↓ 28 ↔ 11 cm



ART. 17616 P
↓ 12 ↔ 7 cm

ART. 17617 P
↓ 15 ↔ 8 cm

ART. 17618 P
↓ 18 ↔ 11 cm

ART. 17619 P
↓ 21 ↔ 13 cm

ART. 17620 P
↓ 24 ↔ 15 cm



ART. 17216 P
↓ 12 ↔ 7 cm

ART. 17217 P
↓ 15 ↔ 8 cm

ART. 17218 P
↓ 19 ↔ 11 cm

ART. 17219 P
↓ 21 ↔ 13 cm

ART. 17220 P
↓ 25 ↔ 15 cm



ART. 16224 Ø 5
↓ 17 ↔ 20 cm

ART. 16029 Ø 5
↓ 18 ↔ 20 cm



ART. 17621 P
↓ 11 ↔ 6 cm
ART. 17622 P
↓ 15 ↔ 7 cm
ART. 17623 P
↓ 18 ↔ 9 cm
ART. 17624 P
↓ 20 ↔ 10 cm

ART. 17222 T
↓ 12 ↔ 6 cm
ART. 17223 P
↓ 16 ↔ 7 cm
ART. 17224 P
↓ 19 ↔ 9 cm
ART. 17225 P
↓ 22 ↔ 10 cm



ART. 16232 Ø 4
↓ 14 ↔ 6 cm
ART. 16233 Ø 5
↓ 17 ↔ 7 cm

ART. 16041 Ø 4
↓ 14 ↔ 6 cm
ART. 16044 Ø 5
↓ 18 ↔ 7 cm



ART. 16234 Ø 5
↓ 17 ↔ 9 cm
ART. 16047 Ø 5
↓ 17 ↔ 9 cm



ART. 17200 P
↓ 31 ↔ 15 cm



ART. 16603 P
↓ 19 ↔ 11 cm

ART. 16405 T
↓ 21 ↔ 11 cm



ART. 17603 P
↓ 20 ↔ 10 cm
ART. 17604 P
↓ 25 ↔ 13 cm
ART. 17202 P
↓ 23 ↔ 10 cm
ART. 17203 P
↓ 28 ↔ 13 cm



ART. 17625 P
↓ 15 ↔ 13 cm
ART. 17626 P
↓ 19 ↔ 14 cm
ART. 17627 P
↓ 20 ↔ 15 cm

ART. 17226 P
↓ 17 ↔ 13 cm
ART. 17227 P
↓ 20 ↔ 14 cm
ART. 17228 P
↓ 23 ↔ 15 cm



ART. 16246 Ø 4
↓ 14 ↔ 13 cm
ART. 16247 Ø 5
↓ 17 ↔ 14 cm

ART. 16071 Ø 4
↓ 14 ↔ 13 cm
ART. 16073 Ø 5
↓ 17 ↔ 14 cm



ART. 16245 Ø 5
↓ 17 ↔ 14 cm
ART. 16068 Ø 5
↓ 18 ↔ 14 cm



ART. 16600 P
↓ 13 ↔ 7 cm
ART. 16611
↓ 15 ↔ 11 cm

ART. 16401 T
↓ 14 ↔ 7 cm
ART. 16415
↓ 17 ↔ 11 cm



ART. 16604 P
↓ 15 ↔ 9 cm

ART. 16407 T
↓ 15 ↔ 9 cm



ART. 17640 P
↓ 17,5 ↔ 8 cm



ART. 16200 Ø 5
↓ 15 ↔ 8 cm



ART. 17641 P
↓ 17,5 ↔ 8 cm



ART. 16640 Ø 5
↓ 15 ↔ 8 cm



ART. 16432 T
↓ 32 ↔ 18 cm



ART. 16605 P
↓ 20 ↔ 12 cm

ART. 16408 T
↓ 22 ↔ 12 cm



ART. 10891
Ø 12 cm



ART. 10890
Ø 12 cm



ART. 17515 I
↑ 4,5 Ø 19 cm
int. inox 70902



ART. 17510 I
↑ 3 Ø 13,5 cm
int. inox 70910



ART. 17511 Ø 15 cm

Portafiore Incasso in rame cromato con anello in acciaio inox 18/10

ART. 17516 P
↑ 4,5 Ø 19 cm
int. plastica 70235

ART. 17512 P
↑ 3 Ø 13,5 cm
int. plastica 73660 + ghiera

lampada elettrica da appendere



ART. 16810
↑ 68 → 20 cm
fiamma Ø 8



ART. 16516
fiamma Ø 6
↑ 3 Ø 13,5 cm



ART. 16515
fiamma Ø 5
↑ 2,5 Ø 9 cm



ART. 11700 9x12 cm
ART. 11701 11x15 cm
ART. 11706 13x18 cm



ART. 11720 9x12 cm
ART. 11721 10x15 cm
ART. 11722 11x15 cm
ART. 11719 13x18 cm



ART. 11702 9x12 cm
ART. 11703 11x15 cm
ART. 11740 13x18 cm



ART. 11723 9x12 cm
ART. 11724 10x15 cm
ART. 11725 11x15 cm
ART. 11741 13x18 cm

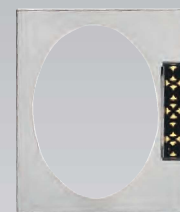

ART. 11704 9x12 cm
ART. 11705 11x15 cm
ART. 11707 13x18 cm



ART. 11726 9x12 cm
ART. 11727 10x15 cm
ART. 11728 11x15 cm
ART. 11733 13x18 cm



ART. 11710 9x12 cm
ART. 11711 11x15 cm
ART. 11709 13x18 cm



ART. 11730 9x12 cm
ART. 11731 10x15 cm
ART. 11732 11x15 cm
ART. 11729 13x18 cm



ART. 11685 9x12 cm
ART. 11686 11x15 cm



ART. 11660 9x12 cm



ART. 11680 Ø 12 cm
ART. 11681 Ø 8 cm
ART. 11682 Ø 10 cm



Inclinazione a richiesta su tutti i tipi cornici

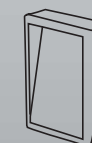

Inclinazione a richiesta su tutti i tipi cornici



ART. 11601 7x9 cm
ART. 11602 8x10 cm
ART. 11603 9x12 cm
ART. 11604 11x15 cm



ART. 11610 7x9 cm
ART. 11611 8x10 cm
ART. 11612 9x12 cm
ART. 11613 10x15 cm
ART. 11614 11x15 cm
ART. 11615 13x18 cm
ART. 11616 18x24 cm



ART. 11640 7x9 cm
ART. 11641 8x10 cm
ART. 11642 9x12 cm
ART. 11643 11x15 cm
ART. 11644 13x18 cm



ART. 11650 9x12 cm



Inclinata ovale
ART. 18135
9x12 cm
ART. 18136
11x15 cm



Inclinata rettangolare
ART. 18137
9x12 cm
ART. 18138
11x15 cm



ART. 18036
9x12 cm
ART. 18037
11x15 cm

PORTARITRATTI



ART. 11607
9x12 cm
ART. 11608
11x15 cm



ART. 11621
9x12 cm



ART. 11605
9x12 cm
ART. 11606
11x15 cm



ART. 11620
9x12 cm



ART. 18030
17x13,5 cm
x cornice 9x12 cm
ART. 18031
22x17,5 cm
x cornice 11x15 cm
ART. 18032
26,5x20,5 cm
x cornice 13x18 cm



ART. 18033
18x14,5 cm
x cornice 9x12 cm
ART. 18034
22x18 cm
x cornice 11x15 cm
ART. 18035
26,5x21 cm
x cornice 13x18 cm



ART. 18104
9x12 cm
ART. 18105
11x15 cm
ART. 18107
13x18 cm



ART. 18126
9x12 cm
ART. 18127
10x15 cm
ART. 18128
11x15 cm
ART. 18133
13x18 cm



Inclinazione a richiesta su tutti i tipi cornici

Portaritratti per l'applicazione di qualsiasi tipo di cornice. Al prezzo del portaritratto va aggiunto il prezzo delle cornici desiderate.

Portaritratti per l'applicazione di qualsiasi tipo di cornice. Al prezzo del portaritratto va aggiunto il prezzo delle cornici desiderate.



ART. 12256
↓ 6 ↔ 2 cm



Croci in tubolare parete e terreno
sezione ↓ 10 ↔ 20 mm
↓ 15 ↔ 25 mm
↓ 20 ↔ 30 mm
↓ 40 ↔ 40 mm

misure a richiesta
chiedere preventivo



Cristo
ART. 12010
↓ 10 ↔ 9 cm
ART. 12017
↓ 18 ↔ 15 cm
ART. 12022
↓ 23 ↔ 19 cm



ART. 14450
↓ 10 ↔ 5 cm
ART. 14451
↓ 15 ↔ 7,5 cm
ART. 14452
↓ 20 ↔ 10 cm



Croci a parete con Cristo 5x10 mm
ART. 14015 ↓ 15 ↔ 10 cm
ART. 14020 ↓ 20 ↔ 10 cm
ART. 14025 ↓ 25 ↔ 10 cm
ART. 14030 ↓ 30 ↔ 10 cm
ART. 14035 ↓ 35 ↔ 10 cm
ART. 14040 ↓ 40 ↔ 10 cm



Croci a parete ↓ 5 ↔ 10 mm
ART. 12408 ↓ 8 ↔ 4 cm
ART. 12410 ↓ 10 ↔ 4 cm
ART. 12412 ↓ 12 ↔ 5 cm
ART. 12415 ↓ 15 ↔ 5 cm
ART. 12420 ↓ 20 ↔ 6 cm
ART. 12425 ↓ 25 ↔ 7 cm
ART. 12430 ↓ 30 ↔ 8 cm
ART. 12435 ↓ 35 ↔ 8 cm
ART. 12440 ↓ 40 ↔ 10 cm



ART. 14531 ↓ 15 ↔ 7 cm
ART. 14532 ↓ 20 ↔ 9 cm
ART. 14533 ↓ 25 ↔ 11 cm
ART. 14534 ↓ 30 ↔ 13 cm



ART. 14545 ↓ 15 ↔ 7 cm
ART. 14546 ↓ 20 ↔ 9 cm
ART. 14547 ↓ 25 ↔ 11 cm
ART. 14548 ↓ 30 ↔ 13 cm
ART. 14535 ↓ 45 ↔ 15 cm



ART. 14538
↓ 45 ↔ 15 cm



ART. 14250
↓ 20 ↔ 8 cm
ART. 14251
↓ 30 ↔ 13 cm



ART. 14260
↓ 20 ↔ 8 cm
ART. 14261
↓ 30 ↔ 13 cm

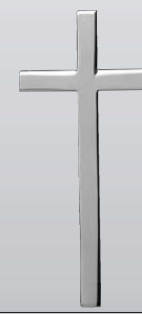

ART. 14297 ↓ 10 cm
ART. 14298 ↓ 12 cm
ART. 14299 ↓ 15 cm
ART. 14300 ↓ 20 cm
ART. 14301 ↓ 25 cm



ART. 14302 ↓ 10 cm
ART. 14303 ↓ 12 cm
ART. 14304 ↓ 15 cm
ART. 14305 ↓ 20 cm
ART. 14306 ↓ 25 cm



ART. 15010
↓ 10 ↔ 4 cm

ACCIAIO INOX

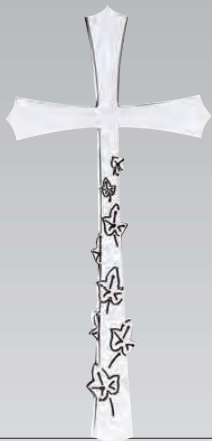

ART. 14292 ↓ 10 ↔ 5 cm P
 ART. 14293 ↓ 20 ↔ 10 cm
 ART. 14294 ↓ 30 ↔ 14 cm
 ART. 14295 ↓ 40 ↔ 16 cm
 ART. 14296 ↓ 50 ↔ 16 cm



ART. 14282 ↓ 10 ↔ 5 cm P
 ART. 14283 ↓ 20 ↔ 10 cm
 ART. 14284 ↓ 30 ↔ 14 cm
 ART. 14285 ↓ 40 ↔ 16 cm
 ART. 14286 ↓ 50 ↔ 16 cm



ART. 14267 ↓ 10 ↔ 5 cm P
 ART. 14268 ↓ 20 ↔ 10 cm
 ART. 14269 ↓ 30 ↔ 14 cm
 ART. 14270 ↓ 40 ↔ 16 cm
 ART. 14271 ↓ 50 ↔ 16 cm



ART. 14277 ↓ 10 ↔ 5 cm P
 ART. 14278 ↓ 20 ↔ 10 cm
 ART. 14279 ↓ 30 ↔ 14 cm
 ART. 14280 ↓ 40 ↔ 16 cm
 ART. 14281 ↓ 50 ↔ 16 cm



ART. 14272 ↓ 10 ↔ 5 cm P
 ART. 14273 ↓ 20 ↔ 10 cm
 ART. 14274 ↓ 30 ↔ 14 cm
 ART. 14275 ↓ 40 ↔ 16 cm
 ART. 14276 ↓ 50 ↔ 16 cm



ART. 14287 ↓ 10 ↔ 5 cm P
 ART. 14288 ↓ 20 ↔ 10 cm
 ART. 14289 ↓ 30 ↔ 14 cm
 ART. 14290 ↓ 40 ↔ 16 cm
 ART. 14291 ↓ 50 ↔ 16 cm



ART. 14262 ↓ 10 ↔ 5 cm P
 ART. 14263 ↓ 20 ↔ 10 cm
 ART. 14264 ↓ 30 ↔ 14 cm
 ART. 14265 ↓ 40 ↔ 16 cm
 ART. 14266 ↓ 50 ↔ 16 cm

IN BASE ALLA DIMENSIONE POSSONO SUBIRE VARIAZIONI DI FORMA

IN BASE ALLA DIMENSIONE POSSONO SUBIRE VARIAZIONI DI FORMA



ART. 16074
fiamma Ø 5
↓ 12 ↔ 8,5 cm



ART. 16076
fiamma Ø 5
↓ 12 ↔ 7 cm

ART. 16076SF
solo ghiera



ART. 16075
fiamma Ø 4
↓ 10 ↔ 6,5 cm

ART. 16080
↓ 13 ↔ 6,5 cm
per fiamma Ø 5
con attacco Ø 4



ART. 16077
fiamma Ø 4
↓ 8,5 ↔ 6 cm

ART. 16077SF
solo ghiera



* Borchia
ART. 10866 Ø
4 cm



Borchia
* ART. 10800
Ø 2,5 cm
* ART. 10810
Ø 3,5 cm
* ART. 10820
Ø 5 cm
* ART. 10821
Ø 6 cm
ART. 10830
Ø 7,5 cm
perno Ø 8 MA



* Borchie
ART. 10840
↓ 3,5 ↔ 3,5 cm
ART. 10850
↓ 4 ↔ 4 cm
ART. 10860
↓ 5 ↔ 5 cm



ART. 16079
fiamma Ø 5
↓ 12 ↔ 7 cm



ART. 16081 Ø 4
↓ 9 ↔ 6 cm



* Borchia
ART. 10867
Ø 5 cm



* Borchie in acciaio pesante
ART. 10869
Ø 3,5 cm
ART. 10870
Ø 5 cm



Ghiera Inox
ART. 16082 Ø 5
↓ 13 ↔ 7 cm



Ghiera Inox Disassata
ART. 16083 Ø 5
↓ 13 ↔ 7 cm

* I prezzi delle borchie si intendono senza perni e sono predisposte di serie per il perno di Ø 5 MA - ART. 91150

Avvertenze per l'utente: le staffe o borchie portanti, raffigurate nel presente catalogo, sono realizzate con materiale di qualità tale da consentire il mantenimento nel tempo delle loro caratteristiche. La funzionalità e la sicurezza delle stesse è condizionata alla corretta installazione che prevede l'utilizzo di due staffe o borchie sul lato inferiore e due sul lato superiore di ogni lastra coprolucolo.

Note for the user: the support brackets or load bearing stud, shown in this catalogue, have been made with special quality material that maintains its characteristics with the passing of time. The functionality and safety of these items depends upon their correct installation, which provides for the use of two brackets or studs on the lower side and two on the upper side of each loculus cover slab/plate.

Borchia regolabile portante a croce



ART. 10805 Ø 2,5 cm
 ART. 10815 Ø 3,5 cm
 ART. 10825 Ø 5 cm
 prezzo del perno escluso



ART. 10845 Ø 5 cm
 Perno Ø 8 MA x 130 compreso nel prezzo.

Staffe regolabili portanti per marmo da mm 7-22

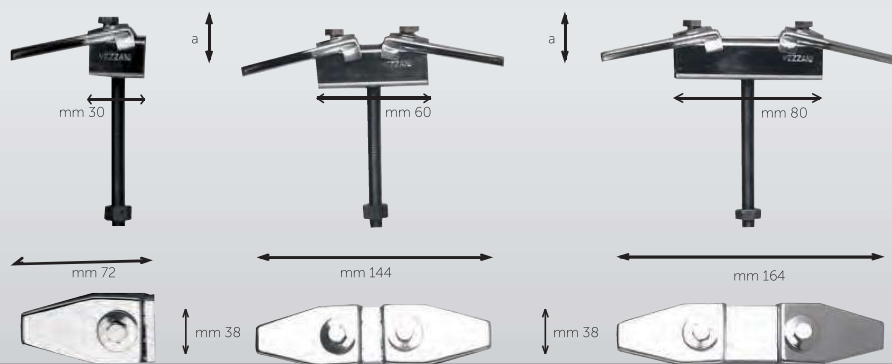

ART. 10875
 a=mm 7-22

ART. 10876
 a=mm 7-22

ART. 10877
 a=mm 7-22

a= spessore marmo

Perno Ø 8 MA x90 compreso nel prezzo

esempio di staffe regolabili portanti montate



ACCIAIO INOX

Avvertenze per l'utente: le staffe o borchie portanti, raffigurate nel presente catalogo, sono realizzate con materiale di qualità tale da consentire il mantenimento nel tempo delle loro caratteristiche. La funzionalità e la sicurezza delle stesse è condizionata alla corretta installazione che prevede l'utilizzo di due staffe o borchie sul lato inferiore e due sul lato superiore di ogni lastra coprioculo.

Note for the user: the support brackets or load bearing stud, shown in this catalogue, have been made with special quality material that maintains its characteristics with the passing of time. The functionality and safety of these items depends upon their correct installation, which provides for the use of two brackets or studs on the lower side and two on the upper side of each loculus cover slab/plate.

Avvertenze per l'utente: le staffe o borchie portanti, raffigurate nel presente catalogo, sono realizzate con materiale di qualità tale da consentire il mantenimento nel tempo delle loro caratteristiche. La funzionalità e la sicurezza delle stesse è condizionata alla corretta installazione che prevede l'utilizzo di due staffe o borchie sul lato inferiore e due sul lato superiore di ogni lastra coprioculo.

Note for the user: the support brackets or load bearing stud, shown in this catalogue, have been made with special quality material that maintains its characteristics with the passing of time. The functionality and safety of these items depends upon their correct installation, which provides for the use of two brackets or studs on the lower side and two on the upper side of each loculus cover slab/plate.



Catena
ART. 11200
maglia 5 cm.
prezzo al metro



Catena
ART. 11205
maglia 7 cm
prezzo al metro



ART. 18650
↓ 14 ↔ 12 cm



ART. 18600
↓ 15 ↔ 9 cm



Perni
ART. 91450
5 MA ↔ 50 mm

ART. 91460
5 MA ↔ 60 mm

ART. 91470
5 MA ↔ 70 mm



Perno **ART. 91130**
3 MA X 35

Perno **ART. 91140**
4 MA X 50

Perno **ART. 91150**
5 MA X 50

Perno **ART. 91154**
6 MA X 60

Perno **ART. 91160**
5 MA X 60

Perno **ART. 91170**
5 MA X 70

Perno **Art. 91180**
5 MA X 80



Perni
ART. 91570
Ø ↓ 5 ↔ 70 mm

ART. 91580
Ø ↓ 6 ↔ 80 mm

ART. 91590
Ø ↓ 8 ↔ 100 mm

ART. 91599
Ø ↓ 10 ↔ 100 mm



Inox
ART. 91155
8 MA ↔ 100 mm

ART. 91156
10 MA ↔ 100 mm



Perni
ART. 91340
TPS da 40 mm

ART. 91350
TPS da 50 mm

ART. 91360
TPS da 60 mm

ART. 91370
TPS da 70 mm



ACCIAIO INOX

CARATTERI

Corsivo Plus

A B C D E F G a b c d e f g h i
 H I J K L M N n j k l m n o p q r
 O P Q R S T U s e t u v w x z
 V W X Y Z 1 2 3 4 5 6 7 8 9 0 * †

13 11 2089
 12 12 1863

IL CORSIVO PLUS PUO' ESSERE RICHIESTO:

COMPRESSO
 Plus

STANDARD
 Plus

ALLARGATO
 Plus

LE DATE POSSONO ESSERE RICHIESTE:

INCORPORATE NELL'ASTA
 13 11 2089

APPOGGIATE NELL'ASTA
 12 12 1863

SE AL MOMENTO DELL'ORDINE NON VIENE EFFETTUATA ALCUNA SPECIFICAZIONE, IL CORSIVO VIENE PRODOTTO AUTOMATICAMENTE STANDARD E CON DATE INCORPORATE NELL'ASTA.

| | | |
|-----------|-------------------------|-----------------|
| ART. 5200 | Lettere/Numeri ↓ mm 15 | spessore mm 2,5 |
| ART. 5201 | Lettere/Numeri ↓ mm 20 | spessore mm 2,5 |
| ART. 5203 | Lettere/Numeri ↓ mm 25 | spessore mm 2,5 |
| ART. 5204 | Lettere/Numeri ↓ mm 30 | spessore mm 2,5 |
| ART. 5205 | Lettere/Numeri ↓ mm 40 | spessore mm 2,5 |
| ART. 5206 | Lettere/Numeri ↓ mm 50 | spessore mm 2,5 |
| ART. 5207 | Lettere/Numeri ↓ mm 60 | spessore mm 2,5 |
| ART. 5208 | Lettere/Numeri ↓ mm 80 | spessore mm 2,5 |
| ART. 5210 | Lettere/Numeri ↓ mm 100 | spessore mm 2,5 |

Punteggiatura gratuita fino al mm. 50

Doratura: aumento del 60%

Lettere e Numeri sciolti: aumento del 20%

- È possibile richiedere il carattere Corsivo Plus di qualsiasi misura, previo preventivo.
- I numeri sono da intendersi su barretta se non diversamente specificato al momento dell'ordine.
- Negli ordini citare sempre l'altezza delle lettere minuscole a corpo semplice (a-c-m-etc...)
- Le lettere maiuscole hanno un'altezza superiore alle lettere minuscole del 100% circa e vengono conteggiate allo stesso prezzo delle lettere minuscole.
- L'altezza delle date è da intendersi asta compresa.

Free punctuation up to 50 mm.

Gilding: 60% increase.

Loose letters and numbers: 20% increase.

- It is possible to ask for the font Corsivo Plus in any size, after a price estimate.
- The numbers are to be meant on underscore if not differently specified at the order.
- In the orders always indicate the height of the lower-case letters in simple type size (a-c-m-, etc...).
- The upper-case letters are higher by about 100% than the lower-case letters, and are counted in the same way as the lower-case letters.
- The height of the dates are always indicated number included underscore.

*Corsivo
Boutique
inox*

Boutique

| | | | |
|-----------|----------------|----------|-----------------|
| ART. 5218 | Lettere/Numeri | ↓ mm 15 | spessore mm 2,5 |
| ART. 5224 | Lettere/Numeri | ↓ mm 20 | spessore mm 2,5 |
| ART. 5229 | Lettere/Numeri | ↓ mm 25 | spessore mm 2,5 |
| ART. 5234 | Lettere/Numeri | ↓ mm 30 | spessore mm 2,5 |
| ART. 5244 | Lettere/Numeri | ↓ mm 40 | spessore mm 2,5 |
| ART. 5254 | Lettere/Numeri | ↓ mm 50 | spessore mm 2,5 |
| ART. 5264 | Lettere/Numeri | ↓ mm 60 | spessore mm 2,5 |
| ART. 5284 | Lettere/Numeri | ↓ mm 80 | spessore mm 2,5 |
| ART. 5297 | Lettere/Numeri | ↓ mm 100 | spessore mm 2,5 |

Punteggiatura gratuita fino a mm 50.

Doratura: aumento del 60%

Lettere e Numeri sciolti: aumento del 20%

- È possibile richiedere il carattere Boutique di qualsiasi misura, previo preventivo.
- Le date possono essere: incorporate - appoggiate - sciolte.
- I numeri sono da intendersi su barretta se non diversamente specificato al momento dell'ordine.
- Negli ordini citare sempre l'altezza delle lettere minuscole a corpo semplice (a-c-m-etc..)
- Le lettere maiuscole hanno un'altezza superiore alle lettere minuscole del 100% circa e vengono conteggiate allo stesso prezzo delle lettere minuscole.
- Le date possono essere richieste solamente appoggiate sull'asta.
- L'altezza delle date è da intendersi asta compresa.

Free punctuation up to 50 mm. Gilding: 60% increase.

Loose letters and numbers: 20% increase.

- It is possible to ask for the font Boutique in any size, after a price estimate.
- The numbers can be requested: on underscore - incorporated - single.
- The numbers are to be meant on underscore if not differently specified at the order.
- In the orders always indicate the height of the lower-case letters in simple type size (a-c-m, etc..).
- The upper-case letters are higher by about 100% than the lower-case letters, and are counted in the same way as the lower-case letters.
- The height of the dates are always indicated number included underscore.

*A B C D E F G
H I J K L M N
O P Q R S T U
V W X Y Z*

*a b c d e f g h i
j k l m n o p q r
s t u v w x y
1 2 3 4 5 6 7 8 9 0 ☆ †*

Corsivo Millennium

IL CORSIVO MILLENNIUM PUÒ ESSERE RICHIESTO:

COMPRESSO

Millennium

STANDARD

Millennium

ALLARGATO

Millennium

LE DATE POSSONO ESSERE RICHIESTE:

INCORPORATE NELL'ASTA

m. 10 12 2003

APPOGGIATE NELL'ASTA

m. 10 12 2003

SE AL MOMENTO DELL'ORDINE NON VIENE EFFETTUATA ALCUNA SPECIFICAZIONE, IL CORSIVO VIENE PRODOTTO AUTOMATICAMENTE STANDARD E CON DATE INCORPORATE NELL'ASTA.

| | | | |
|-----------|----------------|----------|-----------------|
| ART. 5212 | Lettere/Numeri | ↓ mm 12 | spessore mm 2,5 |
| ART. 5215 | Lettere/Numeri | ↓ mm 15 | spessore mm 2,5 |
| ART. 5222 | Lettere/Numeri | ↓ mm 20 | spessore mm 2,5 |
| ART. 5227 | Lettere/Numeri | ↓ mm 25 | spessore mm 2,5 |
| ART. 5232 | Lettere/Numeri | ↓ mm 30 | spessore mm 2,5 |
| ART. 5242 | Lettere/Numeri | ↓ mm 40 | spessore mm 2,5 |
| ART. 5252 | Lettere/Numeri | ↓ mm 50 | spessore mm 2,5 |
| ART. 5262 | Lettere/Numeri | ↓ mm 60 | spessore mm 2,5 |
| ART. 5282 | Lettere/Numeri | ↓ mm 80 | spessore mm 2,5 |
| ART. 5293 | Lettere/Numeri | ↓ mm 100 | spessore mm 2,5 |

A B C D E F G H I a b c d e f g h i
J K L M N O P j k l m n o p q r
Q R S T U V W s e t u v w x z
X Y Z 1 2 3 4 5 6 7 8 9 0 † ☆ ▲ Ω

Punteggiatura gratuita fino al mm 50

Doratura: aumento del 60%

Lettere e Numeri sciolti: aumento del 20%

- È possibile richiedere il carattere Corsivo Millennium di qualsiasi misura, previo preventivo.
- I numeri sono da intendersi su barretta se non diversamente specificato al momento dell'ordine.
- Negli ordini citare sempre l'altezza delle lettere minuscole a corpo semplice (a-c-m-etc...)
- Le lettere maiuscole hanno un'altezza superiore alle lettere minuscole del 140% circa e vengono conteggiate allo stesso prezzo delle lettere minuscole.
- L'altezza delle date è da intendersi asta compresa.
- Per ART. 5212 non si possono richiedere numeri sciolti e le date sono solo incorporate.

Free punctuation up to 50 mm

Gilding: 60% increase

Loose letters and numbers: 20% increase

- It is possible to ask for the font Millennium italics in any size, after a price estimate
- The numbers are to be meant on underscore if not differently specified at the order.
- In the orders always indicate the height of the lower-case letters in simple type size (a-c-m-, etc...)
- The upper-case letters are higher by about 140% than the lower-case letters, and are counted in the same way as the lower-case letters.
- The height of the dates are always indicated number included underscore.
- For ART. 5212 loose numbers cannot be required and date are only incorporated.



| | | | |
|-----------|----------------|----------|-----------------|
| ART. 5115 | Lettere/Numeri | ↓ mm 15 | spessore mm 2,5 |
| ART. 5121 | Lettere/Numeri | ↓ mm 20 | spessore mm 2,5 |
| ART. 5126 | Lettere/Numeri | ↓ mm 25 | spessore mm 2,5 |
| ART. 5131 | Lettere/Numeri | ↓ mm 30 | spessore mm 2,5 |
| ART. 5141 | Lettere/Numeri | ↓ mm 40 | spessore mm 2,5 |
| ART. 5151 | Lettere/Numeri | ↓ mm 50 | spessore mm 2,5 |
| ART. 5161 | Lettere/Numeri | ↓ mm 60 | spessore mm 2,5 |
| ART. 5181 | Lettere/Numeri | ↓ mm 80 | spessore mm 2,5 |
| ART. 5191 | Lettere/Numeri | ↓ mm 100 | spessore mm 2,5 |

A B C D E F G a b c d e f g h i
 H I J K L M N j k l m n o p q r
 Q R S T U s e t u v w x x
 V W X Y Z 1 2 3 4 5 6 7 8 9 0 ☆ † Ω ▲

- Le date possono essere: incorporate - appoggiate - sciolte
- Date con numeri sciolti = aumento del 20%
- Punteggiatura gratuita fino al mm 50
- Negli ordini citare sempre l'altezza delle lettere minuscole a corpo semplice (a-c-m....).
- Le lettere maiuscole hanno un'altezza superiore del 100% circa e vengono conteggiate come le minuscole
- L'altezza delle date indica sempre il numero con asta compresa.
- The numbers can be requested: on underscore - incorporated - single
- Dates with loose numbers: 20% increase
- Free punctuation up to 50 mm.
- In the orders always indicate the height of the lower-case letters in simple type size /a-c-m-etc..)
- The upper case letters are higher by about 100% than the lower-case letters, and are counted in the same way as the lower case letters.
- The height of the dates are always indicated number included underscore.



Per misure superiori: **CHIEDERE PREVENTIVO**
 Il corsivo PLAIN può essere richiesto: **SOLO STANDARD**

- Le date possono essere: incorporate - appoggiate
- Sciolte (con aumento del 20%)
- L'altezza delle date è da intendersi asta compresa
- For sizes bigger ask for an estimate
- Dates can be: inside the bar - on the bar - loose (increase by 20%)
- The height of the dates are always indicated number included underscore

| | | | |
|-----------|----------------|----------|-----------------|
| ART. 5235 | Lettere/Numeri | ↓ mm 15 | spessore mm 2,5 |
| ART. 5236 | Lettere/Numeri | ↓ mm 20 | spessore mm 2,5 |
| ART. 5237 | Lettere/Numeri | ↓ mm 25 | spessore mm 2,5 |
| ART. 5238 | Lettere/Numeri | ↓ mm 30 | spessore mm 2,5 |
| ART. 5239 | Lettere/Numeri | ↓ mm 40 | spessore mm 2,5 |
| ART. 5245 | Lettere/Numeri | ↓ mm 50 | spessore mm 2,5 |
| ART. 5246 | Lettere/Numeri | ↓ mm 60 | spessore mm 2,5 |
| ART. 5247 | Lettere/Numeri | ↓ mm 80 | spessore mm 2,5 |
| ART. 5248 | Lettere/Numeri | ↓ mm 100 | spessore mm 2,5 |

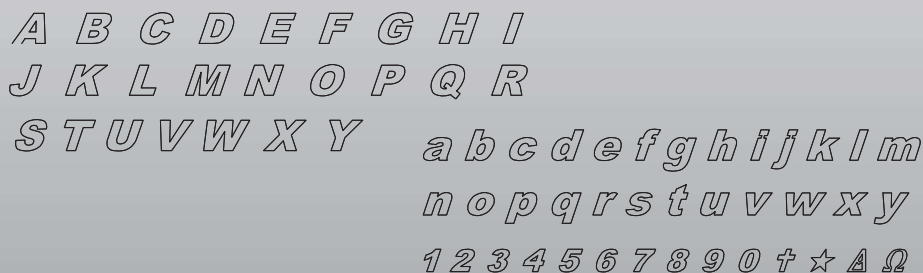

Punteggiatura gratuita fino al mm 50. Doratura: aumento del 60%
 Lettere e Numeri sciolti: aumento del 20%

- È possibile richiedere il carattere Corsivo Plain di qualsiasi misura, previo preventivo.
- I numeri sono da intendersi su barretta se non diversamente specificato al momento dell'ordine.
- Negli ordini citare sempre l'altezza delle lettere minuscole a corpo semplice (a-c-m-etc...)
- Le lettere maiuscole hanno un'altezza superiore alle lettere minuscole del 40% circa e vengono conteggiate allo stesso prezzo delle lettere minuscole

Free punctuation up to 50 mm. Gilding: 60% increase
 Loose letters and numbers: 20% increase

- It is possible to ask for the font Plain italics in any size, after a price estimate
- The numbers are to be meant on underscore if not differently specified at the order
- In the orders always indicate the height of the lower-case letters in simple type size (a-c-m-, etc...)
- The upper-case letters are higher by about 40% than the lower-case letters, and are counted in the same way as the lower-case letters



| | | | |
|-----------|----------------|----------|-----------------|
| ART. 5255 | Lettere/Numeri | ↓ mm 15 | spessore mm 2,5 |
| ART. 5256 | Lettere/Numeri | ↓ mm 20 | spessore mm 2,5 |
| ART. 5257 | Lettere/Numeri | ↓ mm 25 | spessore mm 2,5 |
| ART. 5258 | Lettere/Numeri | ↓ mm 30 | spessore mm 2,5 |
| ART. 5259 | Lettere/Numeri | ↓ mm 40 | spessore mm 2,5 |
| ART. 5265 | Lettere/Numeri | ↓ mm 50 | spessore mm 2,5 |
| ART. 5266 | Lettere/Numeri | ↓ mm 60 | spessore mm 2,5 |
| ART. 5267 | Lettere/Numeri | ↓ mm 80 | spessore mm 2,5 |
| ART. 5268 | Lettere/Numeri | ↓ mm 100 | spessore mm 2,5 |

Punteggiatura gratuita fino al mm 50
 Doratura: aumento del 60%

- Le date possono essere richieste:
- A corpo unico distanziate con punto
 - Sciolte (aumento 20%)
 - Non c'è maiuscola, le lettera hanno tutte la stessa altezza
 - Non è possibile richiederlo compresso o allargato

Free punctuation up to 50 mm
 Gilding: 60% increase

- Dates can be ordered:
- As a unique piece divided by a point
 - Loose (increase by 20%)
 - There is no capital letter, letters have all the same height
 - It's not possible request it compressed or expanded

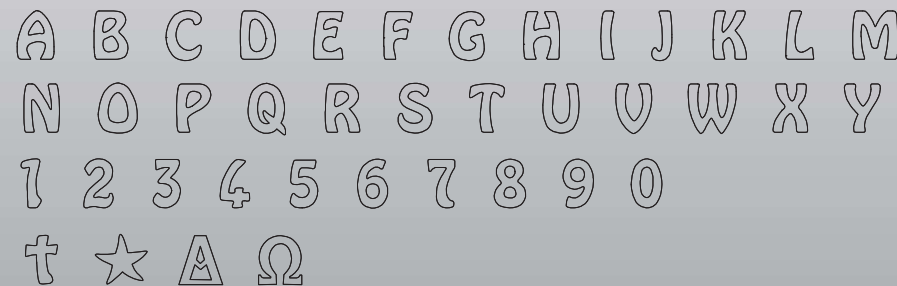

Carattere Digivi



| | | | |
|-----------|----------------|----------|-----------------|
| ART. 5216 | Lettere/Numeri | ↓ mm 15 | spessore mm 2,5 |
| ART. 5223 | Lettere/Numeri | ↓ mm 20 | spessore mm 2,5 |
| ART. 5228 | Lettere/Numeri | ↓ mm 25 | spessore mm 2,5 |
| ART. 5233 | Lettere/Numeri | ↓ mm 30 | spessore mm 2,5 |
| ART. 5243 | Lettere/Numeri | ↓ mm 40 | spessore mm 2,5 |
| ART. 5253 | Lettere/Numeri | ↓ mm 50 | spessore mm 2,5 |
| ART. 5263 | Lettere/Numeri | ↓ mm 60 | spessore mm 2,5 |
| ART. 5283 | Lettere/Numeri | ↓ mm 80 | spessore mm 2,5 |
| ART. 5294 | Lettere/Numeri | ↓ mm 100 | spessore mm 2,5 |

A B C D E F G a b c d e f g h i
 H I J K L M j k l m n o p q r
 X Q P Q R S T s e t u u u x z
 U V W X Y Z 1 2 3 4 5 6 7 8 9 0 † ☆

Punteggiatura gratuita fino al mm 50

Doratura: aumento del 60%

Lettere e Numeri sciolti: aumento del 20%

- È possibile richiedere il carattere Digivi di qualsiasi misura, previo preventivo.
- Le date possono essere: incorporate - appoggiate - sciolte
- I numeri sono da intendersi su barretta se non diversamente specificato al momento dell'ordine.
- Negli ordini citare sempre l'altezza delle lettere minuscole a corpo semplice (a-c-m-etc...)
- Le lettere maiuscole hanno un'altezza superiore alle lettere minuscole del 100% circa e vengono conteggiate allo stesso prezzo delle lettere minuscole
- Le date possono essere richieste solamente appoggiate sull'asta.
- L'altezza delle date è da intendersi asta compresa.

Free punctuation up to 50 mm

Gilding: 60% increase

Loose letters and numbers: 20% increase

- It is possible to ask for the font Digivi in any size, after a price estimate
- The numbers can be requested: on underscore - incorporated - single
- The numbers are to be meant on underscore if not differently specified at the order
- In the orders always indicate the height of the lower-case letters in simple type size (a-c-m-, etc...)
- The upper-case letters are higher by about 100% than the lower-case letters, and are counted in the same way as the lower-case letters.
- The height of the dates are always indicated number included underscore.

ANTARES

| | | |
|-----------|----------------|--------------------------|
| ART. 5217 | Lettere/Numeri | ↓ mm 15 spessore mm 2,5 |
| ART. 5220 | Lettere/Numeri | ↓ mm 20 spessore mm 2,5 |
| ART. 5225 | Lettere/Numeri | ↓ mm 25 spessore mm 2,5 |
| ART. 5230 | Lettere/Numeri | ↓ mm 30 spessore mm 2,5 |
| ART. 5240 | Lettere/Numeri | ↓ mm 40 spessore mm 2,5 |
| ART. 5250 | Lettere/Numeri | ↓ mm 50 spessore mm 2,5 |
| ART. 5260 | Lettere/Numeri | ↓ mm 60 spessore mm 2,5 |
| ART. 5280 | Lettere/Numeri | ↓ mm 80 spessore mm 2,5 |
| ART. 5290 | Lettere/Numeri | ↓ mm 100 spessore mm 2,5 |
| ART. 5291 | Lettere/Numeri | ↓ mm 120 spessore mm 2,5 |
| ART. 5295 | Lettere/Numeri | ↓ mm 150 spessore mm 2,5 |
| ART. 5296 | Lettere/Numeri | ↓ mm 200 spessore mm 2,5 |

A B C D E F G H K
 I J L M N O P Q R S
 T U V W X Y Z
 1 2 3 4 5 6 7 8 0 ☆ † P
 X

- È possibile richiedere il carattere ANTARES di qualsiasi misura previo preventivo.
- I numeri si intendono su barretta.
- Per lettere e numeri singoli aumento del 20%.
- L'altezza delle date è da intendersi asta compresa.

- It is possible to ask for the font Antares in upon estimate.
- The numbers are to be meant on underscore if not differently specified at the order.
- For single letters and numbers: increase 20%.
- The height of the dates are always indicated number included underscore.

A B C D E F G H I J K L M
 N O P Q R S T U V W X Y
 1 2 3 4 5 6 7 8 9 0 † ☆ Δ Ω

PER COMPOSIZIONI EPIGRAFI AUMENTO DEL 20%

| | | |
|-----------|-----------------------------|-------------------------|
| ART. 5420 | Lettere/Numeri/Stella/Croce | ↓ mm 20 |
| ART. 5425 | Lettere/Numeri/Stella/Croce | ↓ mm 25 |
| ART. 5435 | Lettere/Numeri/Stella/Croce | ↓ mm 35 |
| ART. 5445 | Lettere | ↓ mm 45 |
| ART. 5460 | Lettere | ↓ mm 60 |
| ART. 5461 | Pax | ↓ mm 60 |
| ART. 5480 | Pax | ↓ mm 80 |
| ART. 5491 | Pax | ↓ mm 100 |
| ART. 5496 | Trattino | per ↓ 20-25-35-45-60 mm |
| ART. 5497 | Virgola | per ↓ 20-25-35-45-60 mm |
| ART. 5499 | Punto quadrato | per ↓ 20-25-35-45-60 mm |

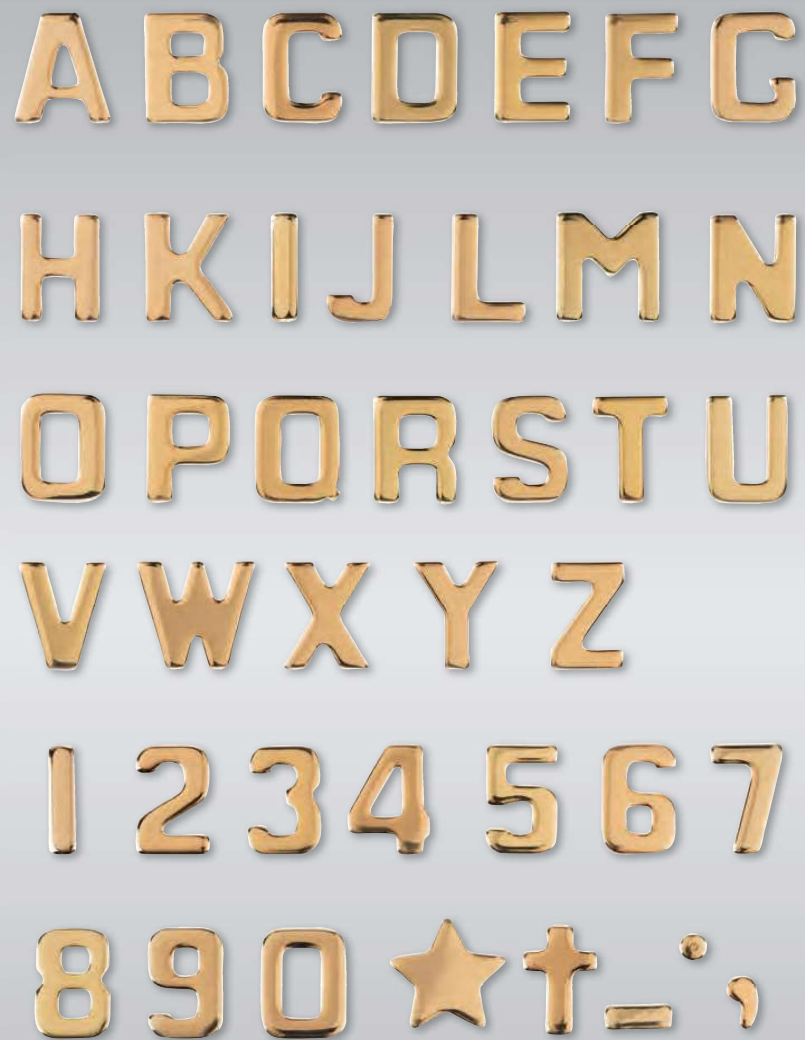

| | | |
|-----------|-----------------------------|----------------------|
| ART. 5826 | Lettere/Numeri/Stella/Croce | ↓ mm 25 |
| ART. 5831 | Lettere/Numeri/Stella/Croce | ↓ mm 30 |
| ART. 5841 | Lettere | ↓ mm 40 |
| ART. 5851 | Lettere | ↓ mm 50 |
| ART. 5893 | Trattino | per ↓ 25-30-40-50 mm |
| ART. 5894 | Virgola | per ↓ 25-30-40-50 mm |
| ART. 5895 | Punto | per ↓ 25-30-40-50 mm |



PER COMPOSIZIONI EPIGRAFI AUMENTO DEL 20%

| | | |
|-----------|-----------------------------|----------------------|
| ART. 5825 | Lettere/Numeri/Stella/Croce | ↓ mm 25 |
| ART. 5830 | Lettere/Numeri/Stella/Croce | ↓ mm 30 |
| ART. 5840 | Lettere | ↓ mm 40 |
| ART. 5850 | Lettere | ↓ mm 50 |
| ART. 5891 | Lettere | ↓ mm 100 |
| ART. 5896 | Trattino | per ↓ 25-30-40-50 mm |
| ART. 5828 | Virgola | per ↓ 25-30-40-50 mm |
| ART. 5899 | Punto | per ↓ 25-30-40-50 mm |

Acciaio inox



PER COMPOSIZIONI EPIGRAFI AUMENTO DEL 20%

| | | |
|-----------|-----------------------------|----------------------|
| ART. 5827 | Lettere/Numeri/Stella/Croce | ↓ mm25 |
| ART. 5832 | Lettere/Numeri/Stella/Croce | ↓ mm30 |
| ART. 5842 | Lettere | ↓ mm40 |
| ART. 5852 | Lettere | ↓ mm50 |
| ART. 5892 | Virgola | per ↓ 20-30-40-50 mm |
| ART. 5897 | Trattino | per ↓ 20-30-40-50 mm |
| ART. 5898 | Punto | per ↓ 20-30-40-50 mm |

ISTRUZIONI di MONTAGGIO FUTURO ADESIVO

La superficie di adesione deve essere perfettamente piana e levigata, marmo granito vetro cristallo ecc..



1.
Pulire accuratamente la lastra con alcool.



2.
Tracciare a matita la linea di posizionamento del carattere, oppure usare un righello.



3.
Togliere la protezione in carta dell'adesivo, avendo cura di non toccarlo con le mani.

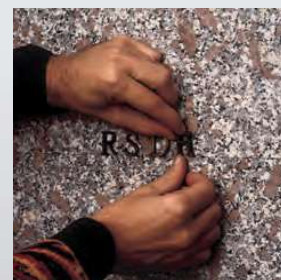

4.
Posizionare la lettera allineandola al segno a matita. L'applicazione deve essere eseguita a temperatura ambiente.



5.
Premere con forza per qualche secondo.

Le operazioni necessarie per il montaggio del carattere Futuro autoadesivo sono identiche al procedimento di applicazione del carattere Romano autoadesivo.

Questo fissaggio rende possibili rapide realizzazioni con la sicurezza di un adesivo resistente a temperatura da -30°C a + 100°C.

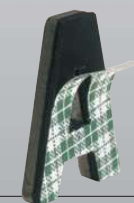

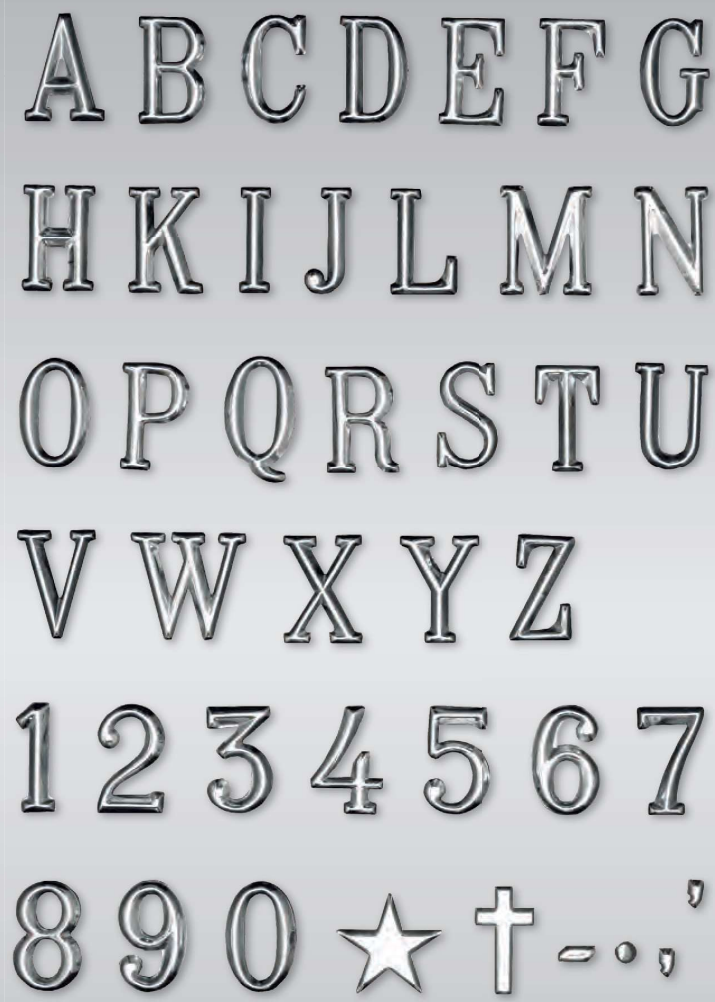

PER COMPOSIZIONI EPIGRAFI AUMENTO DEL 20%

| | | |
|-----------|----------------|----------------------|
| ART. 5725 | Lettere/Numeri | ↓ mm25 |
| ART. 5735 | Lettere/Numeri | ↓ mm35 |
| ART. 5745 | Lettere | ↓ mm45 |
| ART. 5760 | Lettere | ↓ mm60 |
| ART. 5497 | Virgola | per ↓ 25-35-45-60 mm |
| ART. 5596 | Trattino | per ↓ 25-35-45-60 mm |
| ART. 5599 | Punto rotondo | per ↓ 25-35-45-60 mm |



PER COMPOSIZIONI EPIGRAFI AUMENTO DEL 20%

| | | |
|-----------|-----------------------------|----------------------|
| ART. 5120 | Lettere/Numeri/Stella/Croce | ↓ mm20 |
| ART. 5130 | Lettere/Numeri/Stella/Croce | ↓ mm30 |
| ART. 5140 | Lettere | ↓ mm40 |
| ART. 5150 | Lettere | ↓ mm50 |
| ART. 5160 | Pax | ↓ mm60 |
| ART. 5180 | Pax | ↓ mm80 |
| ART. 5497 | Virgola | per ↓ 25-30-40-50 mm |
| ART. 5496 | Trattino | per ↓ 25-30-40-50 mm |
| ART. 5199 | Punto | per ↓ 25-30-40-50 mm |

NOVITÀ

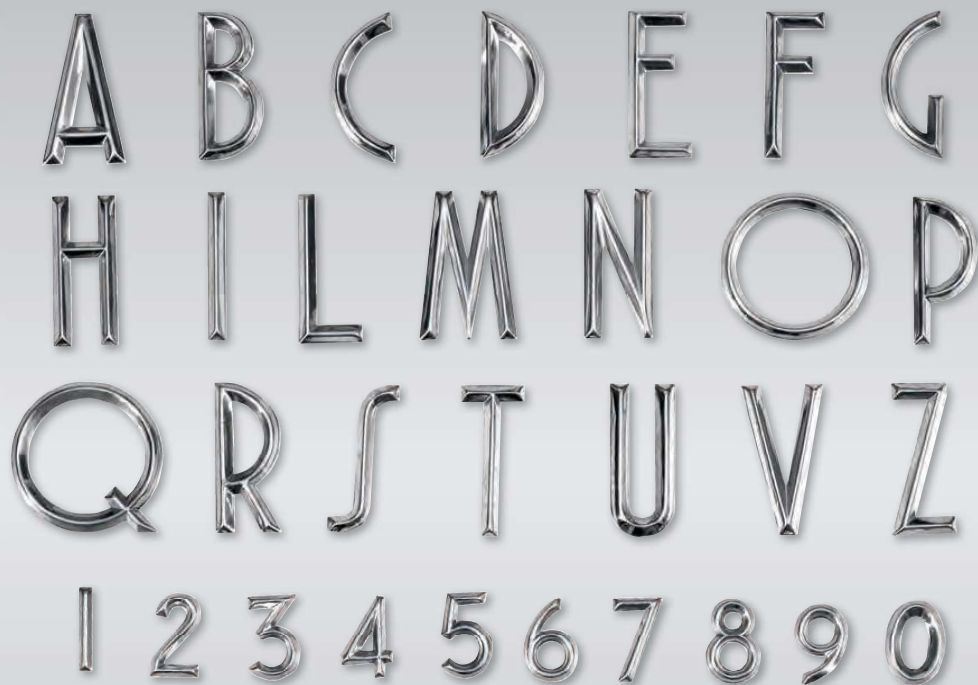

ART. 10043 ↓ 7 ↔ 10 cm
 ART. 10044 ↓ 7,5 ↔ 15 cm
 ART. 10045 ↓ 10 ↔ 20 cm
 ART. 10046 ↓ 15 ↔ 30 cm
 ART. 10047 ↓ 20 ↔ 40 cm



ART. 10048 ↓ 7 ↔ 10 cm
 ART. 10049 ↓ 10 ↔ 15 cm
 ART. 10050 ↓ 15 ↔ 20 cm

PER COMPOSIZIONI EPIGRAFI AUMENTO DEL 20%

| | | |
|-----------|----------------|----------------|
| ART. 5525 | Lettere/Numeri | ↓ mm25 |
| ART. 5545 | Lettere | ↓ mm45 |
| ART. 5497 | Virgola | per ↓ 25-45 mm |
| ART. 5596 | Trattino | per ↓ 25-45 mm |
| ART. 5599 | Punto | per ↓ 25-45 mm |

PERGAMENE PERSONALIZZABILI CON DIMENSIONE A RICHIESTA,
 CHIEDERE PREVENTIVO

LE INCISIONI SULLE PERGAMENE SONO A TITOLO D'ESEMPIO